

KJ00 0099798 X M AD
 T W DENBROOK DIR OF ENG
 KUOW RADIO OF WASHINGTON DIR
 325 CMU-U WA 98195
 SEATTLE

JUNE 1982

\$3.00

BME

BROADCAST MANAGEMENT/ENGINEERING

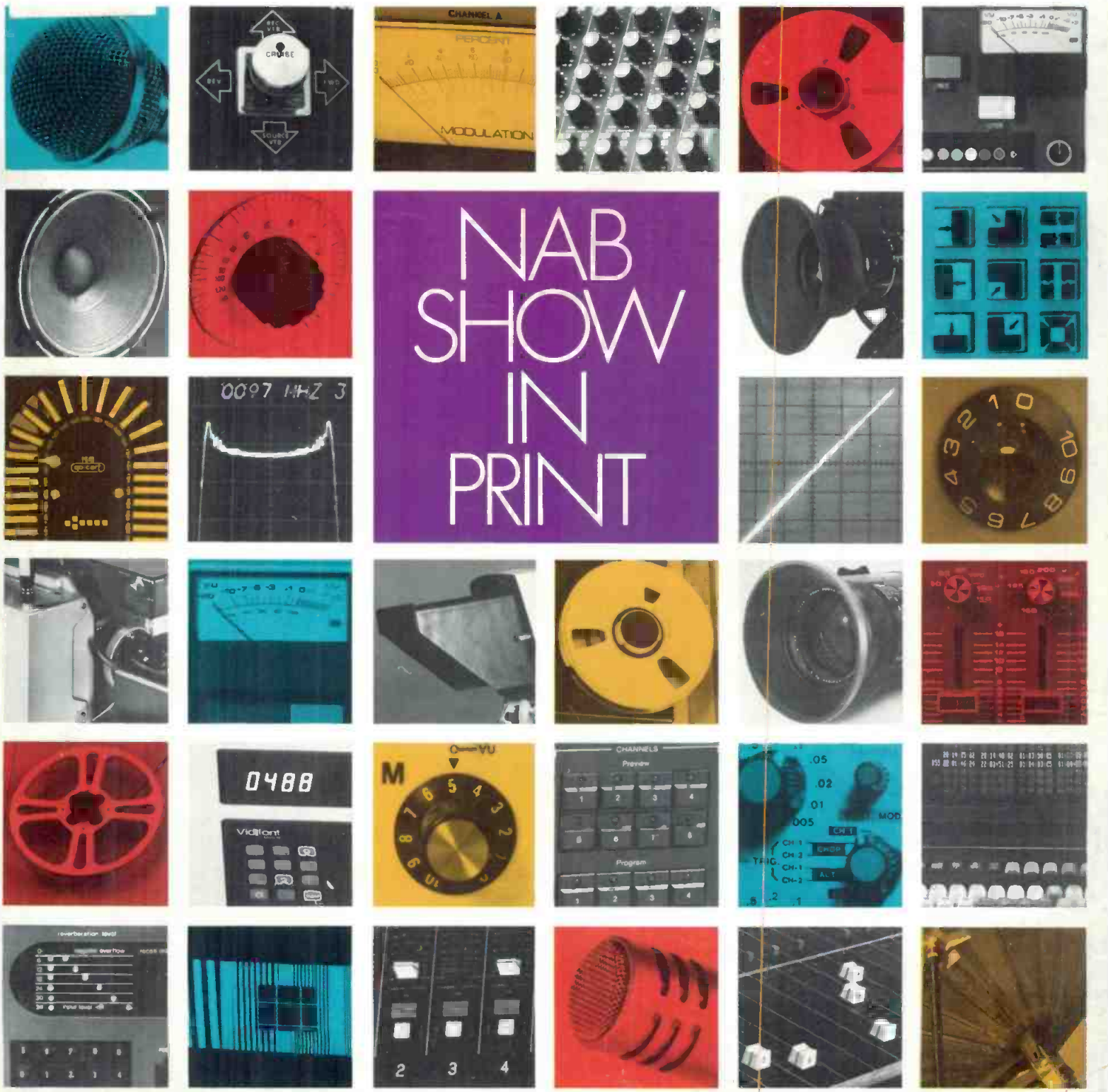

FACT.

TV-3 HAS 8 STEREO GROUPS.

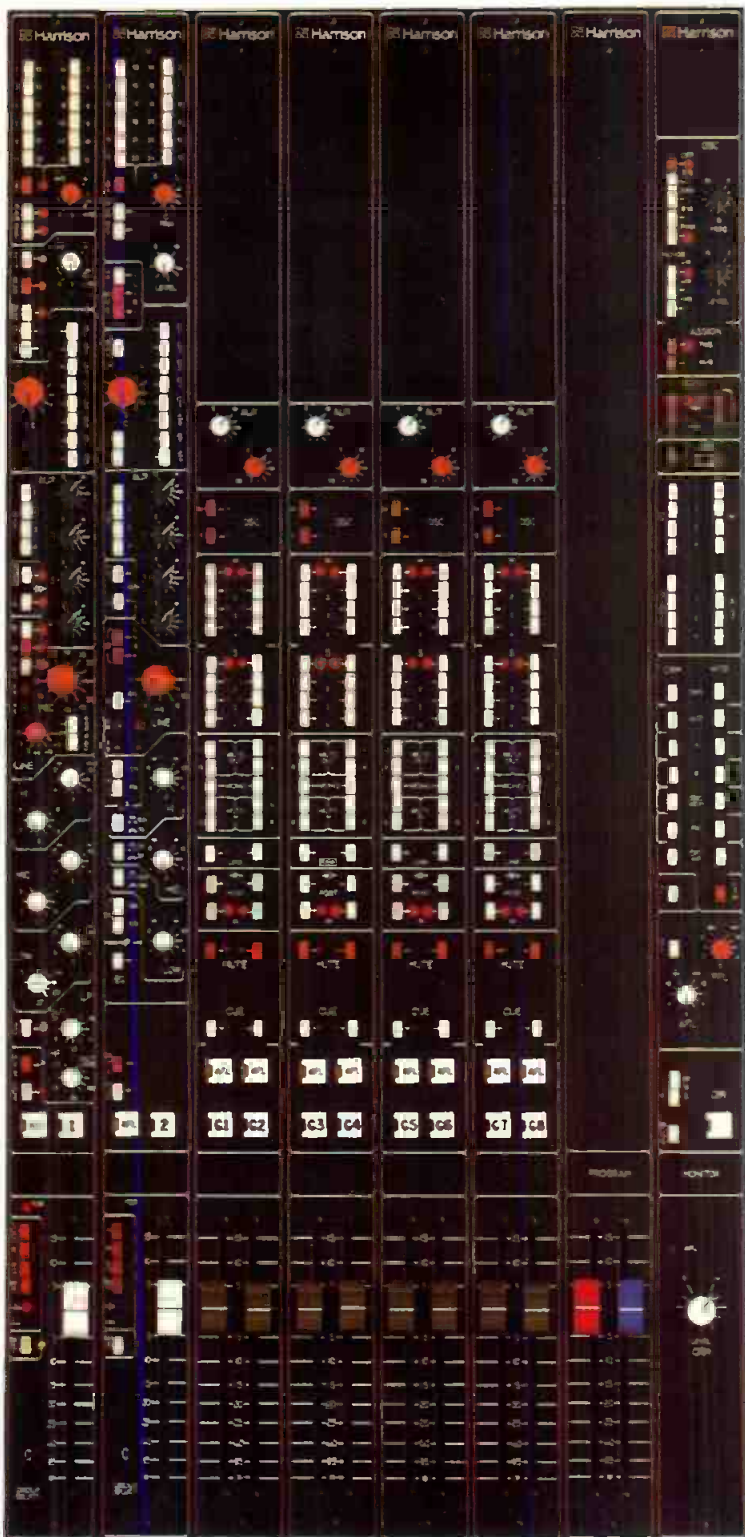

WHY? Any audio console that you purchase today *will* be used for stereo, and a perfectly good 8-bus mono console makes an absolutely awful 4-group stereo console.

FACT.

TV-3 accommodates a 24-track ATR without interfering with normal operations.

WHY? Stereo sound production will ultimately require a small but necessary sound post-production process on some shows. That requires multitrack. The way we've done it, however, will not confuse even the most casual operator.

FACT.

TV-3 is a totally new console design – not a redesigned music or mono-broadcast console.

WHY? We at Harrison Systems feel that in order to be of real service to you, we must give you a tool that has been designed to make maximum use of the new medium, without the restrictions of modified technologies.

If your sound goes with pictures, we have what you need.

 **Harrison**

OTHER FEATURES: 4 stereo program feeds • 4 mono mix-minus feeds • 4 aux-send feeds • Optional VCA grouping • Impeccable Harrison signal-handling • Optional automatic spare supply • Simplified operation • Proven reliability from Harrison

HARRISON SYSTEMS, INC./P.O. Box 22964, Nashville, Tennessee 37202/(615) 834-1184, Telex 555133

Circle 100 on Reader Service Card

www.americanradiohistory.com

ADDA CORPORATION



KEYC-TV, MANKATO, MINN.

Why the Networks' TBC Is Getting Popular in Smaller Markets.

In less than five years, our VW series has become the broadcast industry's basis for comparison in time base correction and frame synchronization. The ADDA VW is standard equipment for 3 of the 4 networks, as well as O and O's.



The affiliates and independents have been watching, listening and making up their minds. More and more of them, even in the medium and smaller markets, are ordering the VW-1 (for 3/4" VTR's) and the VW-2 (for 3/4" and 1" VTR's).

The way we see it, the reasons for this trend are clear:

- Superior digital signal processing
- Unequaled reliability
- Infinite correction window
- Full-bandwidth electronic freeze frame
- Frame synchronization (The VW can take raw external feeds and let you switch them synchronously with studio material.)
- Meets RS-170A

Of course, the VW costs more than some of its competitors. The ultimate usually does. But the difference buys you a great deal more; and the difference may well be less than you think, because prices are lower now.

The best way to understand the difference between the VW and everything else is to watch a side-by-side comparison on your own premises. Call us for a demo. We'll be happy to show you why the VW is a TBC for everybody's market.

Affordable Excellence

ADDA CORPORATION

1671 Dell Avenue
Campbell, California 95008
(408) 379-1500



HOW TO LOSE WEIGHT TAKE BETTER

SONY INTRODUCES THE BETACAM SYSTEM

When we designed the innovative Sony half-inch ENG system, we didn't do it halfway.

So our Betacam™ camera/recorder is 30% lighter than its nearest competitor. And more than 40% smaller. A big difference when you're rushing to cover a story.

But not only have we trimmed pounds and inches, we've saved you dollars and cents. In fact, the entire system is so competitively priced, you might want to buy

two of our camera/recorders rather than one of the heavier, bulkier units around. Then, obviously, you'll be able to cover twice as much news.

The Betacam camera section employs a High-Band SMF Tricon® single-tube pickup system. As a result, it has a dramatically improved picture, with better resolution and more sensitivity than conventional one-tube cameras.

And since it has 60% fewer components than three-tube cameras, the cost of maintaining it is low.



SAVE MONEY, AND PICTURES.

(Of course, there will always be applications where you prefer a three-tube camera. So you'll be delighted to know that Sony also offers a three-tube Betacam.)

The Betacam recorder also provides superior performance, with better picture clarity and a higher signal-to-noise ratio, even when compared to 3/4" machines. It records for 20 minutes on a Beta L-500 cassette, and runs for a full hour on the low-power, rechargeable battery contained in the unit. And both cassettes and batteries are inexpensive and readily available.

A separate playback unit completes the Betacam system. It's the only interface you need for existing post-production equipment. So nothing is made obsolete.

Naturally, there are many other refinements and innovations. So to request more information, call 1-800-526-0890. Or in New Jersey, (201) 256-4512, ext. B1.

Sony Betacam. Like so many other Sony Broadcast products, it seems revolutionary today. And will be indispensable tomorrow.

SONY
Broadcast

Sony is a registered trademark of Sony Corp.

Circle 102 on Reader Service Card

www.americanradiohistory.com

BM/E

BROADCAST MANAGEMENT/ENGINEERING

JUNE 1982/VOLUME 18/NUMBER 6

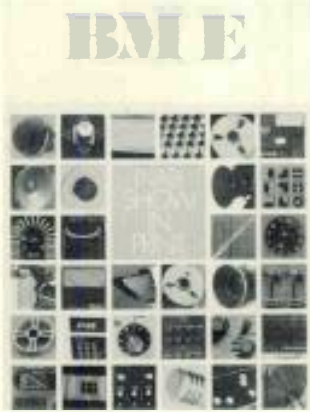

Some of the glittering array of products reviewed in *BM/E's* 1982 Show-In-Print, a comprehensive rundown on new and featured products at the Dallas show. Cover design by Robert Fabian.

NAB photos by Christina Patoski.

Publisher
Charles C. Lenz, Jr.
Editorial Director
Gerald M. Walker
Editor Emeritus
James A. Lippke

Editor
Robert Rivlin
Senior Editor
Robin Lanier
Associate Editor
Eva J. Blinder
Assistant Editor
Tim E. Wetmore
Editorial Production Assistant
Elaine C. Hamill
Assistant to the Editor
Douglas Damoth
Editorial Assistant
Toria Smith
Special Assignments Editor
C. Robert Paulson
Art Director
Saija Osis

Associate Publisher
Djuna Van Vort
Production Director
Janet E. Smith
Advertising Production Assistant
Charles Read
Circulation Manager
Robert Crawford
Reader Service
Sharon Porges

Comptroller
Michael J. Lanni

8 Editorial

De facto AM Stereo

10 Editorial Reply

14 Broadcast Industry News

Mental health study finds clear violence-TV link; CNN-2 aims for affiliates as nets expand newscasts; Group W, NBC disagree over news poll findings

1982 NAB Show-In-Print

37 Audio Report

Consoles 37
ATRs, tape 40
Audio processors 47
Special effects 50
Noise reduction 50
Delay lines 52
Other processors 52
Microphones 52
Intercoms 57

Turntables 57
Amplifying equipment 58
Monitors 58
Remote control, STL, RPU 58
Telco interface 60
Automation 63
Test and measurement 66
Other 66

71 Video Report

Camera overview 71
Recorder/cameras 71
Solid-state cameras 72
ENG cameras 74
Computer-aided cameras 74
Lenses 78
Telecines, film 79
VTRs 80
Videotape, accessories 82
Slow motion recorders 83
Digital art and graphics 84
Character generators 90
Production switchers, special effects 95

Digital effects, still stores 98
Master control, automation 100
Post-production 103
Time code 106
Digital signal processing 110
Pulse and sync 114
Routing switchers 114
Test and measurement 119
Monitors 122
Lighting, sets 122
Power 126
Camera support 131
Racks, cases, furniture 134

137 AM Stereo—can broadcasters influence the outcome?

Practical evaluation by broadcasters may allow them to decide with receiver manufacturers on the free marketplace winner

145 FCC Rules and Regulations

Technical Regulation: Business as Usual

151 Great Idea Contest

1981 contest winners! Vote for this month's winner—enter next month's contest

Coming in July . . .

Mobile vehicle and RF developments at NAB . . . An exclusive report on the cable industry's growing commitment to quality local production . . . Plus the next installment of our **Facilities Design and Engineering** series: **The Radio Station Engineering Plan.**

BROADBAND INFORMATION SERVICES, INC.

295 Madison Ave., New York, N.Y. 10017, 212-685-5320, Telex: 64-4001

Publishers: **BM/E—Broadcast Management Engineering**
BM/E's World Broadcast News



VBPA BME BROADCAST MANAGEMENT ENGINEERING (ISSN 0005-3201) is published monthly by Broadband Information Services Inc. All notices pertaining to undeliverable mail or subscriptions should be addressed to 295 Madison Ave., New York, NY 10017. BM/E is circulated without charge to those responsible for station operation and for specifying and authorizing the purchase of equipment used in broadcast facilities in the U.S. and Canada. These facilities include AM, FM and TV broadcast stations. CATV systems. ETV stations, networks and studios, audio and video recording studios consultants, etc. Subscription prices to others \$24.00 one year, \$36.00 two years. Foreign \$30.00 one year, \$48.00 two years. Air Mail rates on request. Copyright 1982 by Broadband Information Services, Inc., New York City. Second class postage paid N.Y., N.Y. and additional mailing offices.

SUITE SUCCESS

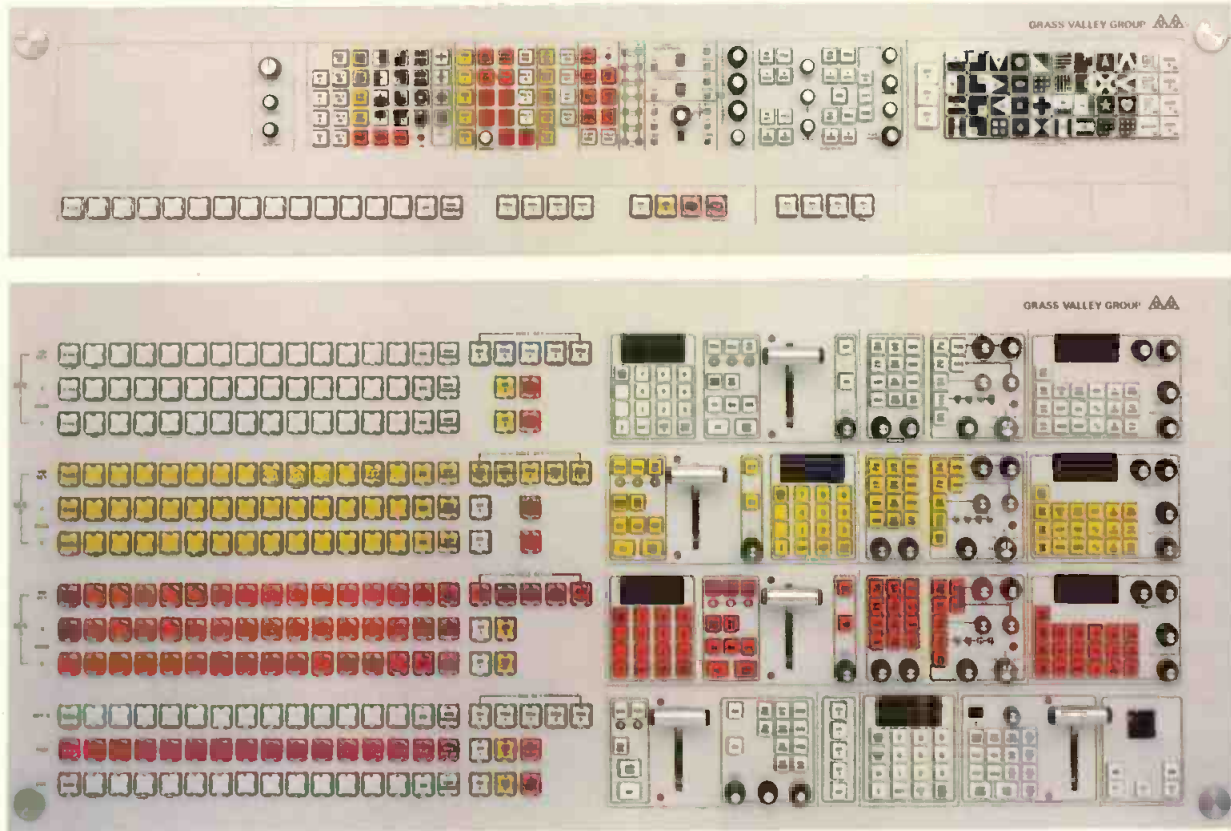

GVG® 300 Switcher and MkII DVE... creative post-production under editor control

More Than 100 In Service

Over 100 broadcasters and production houses are now enjoying the versatile 300 Switcher in the industry's most demanding production environments. Many are now in service in the most advanced edit suites around the world, where the full system capabilities of the 300/MkII are being used.

Total System Control

The 300 Serial Interface option permits control of any part of the switcher for full edit decision list functions, or beyond, to total switcher control using the E-MEM™ effects memory system for complex effects under editor control. A companion audio system readily responds to edit decision list commands over the same serial (RS-232 or 422) port. Most premium grade computer editors on the market now support the 300 Serial Interface...including the storage of complex E-MEM effects in the edit list for future auto assembly.

Now Even More E-MEM Power

Each 300 Switcher includes a powerful E-MEM effects memory system now with *Effects Dissolves and Sequencing* in each mix/effects system. Effects Dissolves permit frame accurate transitions between switcher setups through computer control of all switcher functions, including analog controls. Sequencing allows effects dissolves to be linked together for complex effects. Via the serial interface, all this power can be placed under computer editor control...and now, the MkII DVE can be controlled through the serial interface for total system control, unmatched by any post-production system available today.

Production power, straightforward operation, unique E-MEM effects memory system functions, and the industry standard serial editor interface - a total system. Plus, traditional Grass Valley Group quality and reliability. Why not unleash your creativity with a 300 Production System?

THE GRASS VALLEY GROUP, INC.®

P.O. BOX 1114 GRASS VALLEY CALIFORNIA 95945 USA • TEL: (916) 273-8421 TWX: 910-530-8280

A TEKTRONIX COMPANY

Offices: **Eastern Regional:** 499 Thornall St. Edison, NJ 08817, (201) 549-9600 • **Southeastern District:** 1644 Tullie Circle N.E., Ste 102, Atlanta, GA 30329 (404) 321-4318 • **Midwestern Regional:** 810 West Bristol St, Elkhart, IN 46514 (219) 264-0931 • **Northwestern District:** 3585 North Lexington Ave, Ste 238, Arden Hills, MN 55112 (612) 483-2594 • **Southwestern District:** 316 Seminary South Office Bldg, Fort Worth, TX 76115 (817) 921-9411 • **Western District:** 1032 Elwell Court, Ste 244, Palo Alto, CA 94303 (415) 968-6680 • **Western Regional:** 21243 Ventura Blvd, Ste 206, Woodland Hills, CA 91364 (213) 999-2303

Circle 103 on Reader Service Card

De facto AM Stereo

AS EXPECTED, THE HOOPLA OVER AM STEREO at the recent NAB Convention in Dallas was loud, but not very decisive. In the wake of the FCC's decision to put the choice of a standard system into "the marketplace," broadcasters were still unsure of their final course.

The rub, as we see it, is that the broadcast industry and the radio receiver makers do not necessarily see eye to eye on the best system to serve the public. The AM broadcast industry had hoped for a service that would compete with FM. Radio set makers want to market products that the consumer will buy at what they believe is the right price.

Broadcasters have to make a relatively small investment to get into AM stereo, approximately \$5000 to \$10,000. Set manufacturers, on the other hand, might have to invest millions, and if the final cost is too high, there's the danger that receivers will be priced out of the market.

To make AM stereo competitive with FM, it has to be broader band than monophonic AM. But for the set manufacturer to pull a given signal out of the air amidst a jumble of adjacent channels and distant co-channels, the narrower the band the better. Both sides face the risk that the listener will find AM stereo inferior to FM.

Some of the proposed systems claim better performance than others, but there is no clear definition of best performance. Good separation, low noise, and low distortion may look good on paper, but these qualities may be accompanied by "pops" or spatter in unfavorable circumstances. Best performance then may simply boil down to reliable operation.

To help clarify the situation, the nation's leading auto radio producer, Delco Division of General Motors, has decided to run its own bench and field tests. (See story, p. 137.) Many now believe that the *de facto* standard could come from Delco rather than the Japanese, who nonetheless have a major influence on the market.

Granted that when it arrives, AM stereo will be accompanied by enormous hype. But responsible broadcasters who see AM stereo as an opportunity to enhance service and quality must be heard over the hype. Unfortunately, the mechanism for reaching such a consensus and a standard is not at hand. The FCC, in effect, has played the National Anthem and signed off. What remains is a scramble at ever-increasing stakes that could lead either to a new day for AM radio or chaos.

It is neither practical nor realistic today to develop a universal decoder capable of handling any and all of the AM stereo systems. Moreover, the costs would be too high to try out each system on the public and see which one survives. Clearly, more tests are needed to dispel the present confusion. Delco is taking steps. But broadcasters too must continue their evaluation based on side-by-side comparisons. After all, broadcasters have the burden to choose, quoting that oft-used phrase, "in the public interest."

NEC INTRODUCES THE SMOOTHEST, EASIEST CURVES EVER.

FOR UNDER \$80,000.

With NEC's new E-FLEX DVE® system, you can move a title along a curved trajectory with all the smoothness of film. And with programming that takes seconds, instead of hours.

The secret? NEC's digital processing, plus E-FLEX's huge 128-event built-in memory. Quite an achievement for an under-\$80,000 system. And our trajectory function is only one of the effects it makes possible.

Our exclusive new effects put excitement at your fingertips.

For instance, take Multi-Move. With it, you can turn a moving figure into as many as 16 compressed images—and have the action continue in each frame. And there's an improved, continuously variable mosaic effect that gives you smoother transitions.

E-FLEX also lets you create backgrounds and borders that track through any movement—even flips and tumbles. And in the two-channel mode, its new reciprocal function makes effects like page turns and rotating cubes smooth and simple to program.

Our bubble memory system lets you store effects on the shelf.

If you use the same effects over and over—for opens, closes, and the like—E-FLEX's optional bubble memory will save you hours every time you edit.

You program the effects just once, and transfer them to a bubble memory cartridge. When you need the effects again, simply drop in the cartridge. And since the cartridges last indefinitely—unlike discs or tapes—you may never have to reprogram.

Let us boggle your mind some more.

There are E-FLEX features we haven't even mentioned yet.

And some of them, you'd have to see to believe. That's why we suggest you see E-FLEX for yourself. To arrange a demonstration, call us today at 1-800-323-6656. In Illinois, call (312) 640-3792.

E-FLEX. New from NEC.



NEC

NEC America, Inc.
Broadcast Equipment Division
130 Martin Lane
Elk Grove Village, IL 60007

Circle 104 on Reader Service Card

WHY BUY TWO LENSES WHEN THIS ONE WILL DO?



Schneider 14X ENG/EFP lens zooms from super wide angle to long telephoto.

Changing lenses to handle changing conditions could cost you a once-in-a-lifetime shot. And that's why you should know about the Schneider 14X ENG/EFP lens. It gives you two-lens versatility in an economical one-lens package.

It can power zoom from 9mm–126mm. Or with the built-in 2X extender from 18mm–252mm. With the 6.3mm–9mm aspheric lens attachment, it can power zoom on the super wide angle shots. And, when the action calls for close and tight, it's got macro focusing.

The Schneider 14X is designed to bring out the best in Ampex, CEI, Fernseh, Hitachi, Ikegami, JVC, NEC, Panasonic, Philips, RCA, Sharp, Sony, Thomson and Toshiba $\frac{2}{3}$ " cameras. Lightweight, compact, ruggedly constructed, and weather resistant, it comes with a complete line of accessories. Superb European optics combined with excellent f/1.7 sensitivity bring back crisp, clear pictures even under low light level conditions.

In addition, Schneider offers the 14X lens in a $\frac{1}{2}$ -inch format for the new one-piece VCR cameras such as RCA Hawkeye, Panasonic and Sony. Schneider broadcast lenses are available throughout the United States and Canada from: **TELE-CINE CORP.**, 400 Crossways Park Drive, Woodbury, NY 11797; (516) 496-8500.

Schneider 14X ENG/EFP

Tele-Cine Corp. is a subsidiary of Schneider Corporation of America.

Circle 105 on Reader Service Card

editorial REPLY

In the Editorial for the March issue (p.8) we cautioned that the FCC should go slow on its deregulation program regarding technical requirements. We argued that technical "unregulation" is not in the best interests of broadcasting and could cause undue harm. The following is a thoughtful reply to this Editorial from FCC Commissioner Mimi Weyforth Dawson:

To the Editor:

I was intrigued by your March editorial, "Go slow on technical deregulation." I certainly agree with your assessment that the rush toward deregulation should not encompass all of the Commission's rules and regulations. However, I believe there is a fundamental misconception in your editorial that "technical deregulation" is synonymous with abandonment of spectrum management.

The commission is not attempting to deregulate in vital areas of spectrum management. Such basic areas as power maximums, bandwidth limitations, protected service areas, and other provisions necessary for an orderly allocation scheme will remain regulated.

I believe, on the other hand, that the marketplace can readily control many technical/management-type matters not essential to the allocation processes. Freeing the station managers and engineers to equip their stations as they see fit to serve their audiences will permit use of state-of-the-art equipment and techniques without the need to wait for government approval or rule changes. Managers and engineers should find such an environment highly desirable and, I suspect, they will be able to make better choices in the public interest than the government.

In keeping with your analogy, the Commission will continue to post "speed limits" (power levels) and "stop signs" (emission controls), but the licensee has the ultimate responsibility for a clear signal. If not, the audience and advertiser will find another station.

Sincerely,
Mimi Weyforth Dawson
FCC Commissioner

If you have an opinion about a BM/E Editorial, we would be pleased to receive your Editorial Reply. Mail your comments—pro and con—to The Editor, BM/E, 295 Madison Ave., New York, NY 10017.

MORE THAN A PORTABLE

Acquisition plus studio-type control makes the Ampex VPR-20B your professional portable.

If you need more than just a portable acquisition recorder, choose the improved Ampex VPR-20B. When you go into the field for realism and immediacy, you'll know you've got it. Right the first time with videotape you've already reviewed, edited and played back—on location, ready to air.

It's the VPR-20B's exclusive dual-cue editing that gives it studio-type control in the field. From instant reviews with precise return to the next edit point, to total control when replacing undesired material with mid-segment, color-frame accurate edits. You can now have it all in one easy-to-use portable.

With the VPR-20B you also get top quality audio and video every time. The built-in video confidence and color stabilizer features play the picture back from the tape into the camera viewfinder, or any color monitor,

during recording. So you'll know that the picture you see is the one you've got! And, unlike other portables, the VPR-20B has a simple plug-in AC power pack which replaces the battery. You can forget about bulky external power supplies.

Most of all, the VPR-20B is backed by the unique worldwide service and support that Ampex is known for. So before your next field production, find out more from your Ampex representative. Or write Ampex Corporation, Audio-Video Systems Division, 401 Broadway, Redwood City, CA 94063 (415) 367-2011.

AMPEX TOOLS FOR TOMORROW

Ampex Corporation • One of The Signal Companies

Built-In Color Stabilizer
Lets you show full color in the field without time base correction.

One-hour-plus Tape Capacity
With long battery life.

Tape Timer And Servo System
Makes cues fast, edits clean and color-frame accurate.

Plug-In AC Power Pack
Replaces battery and eliminates bulky external power supplies.

Individual Head Replacement
Quickly with only a screwdriver. No mechanical adjustment or drum change required.

Exclusive Dual-cue Edit Control
Lets you review, return to next edit and replace unacceptable material with mid-segment edits.

Circle 106 on Reader Service Card

www.americanradiohistory.com

INTRODUCING THE XC EVERYONE ELSE OUT AGAIN.

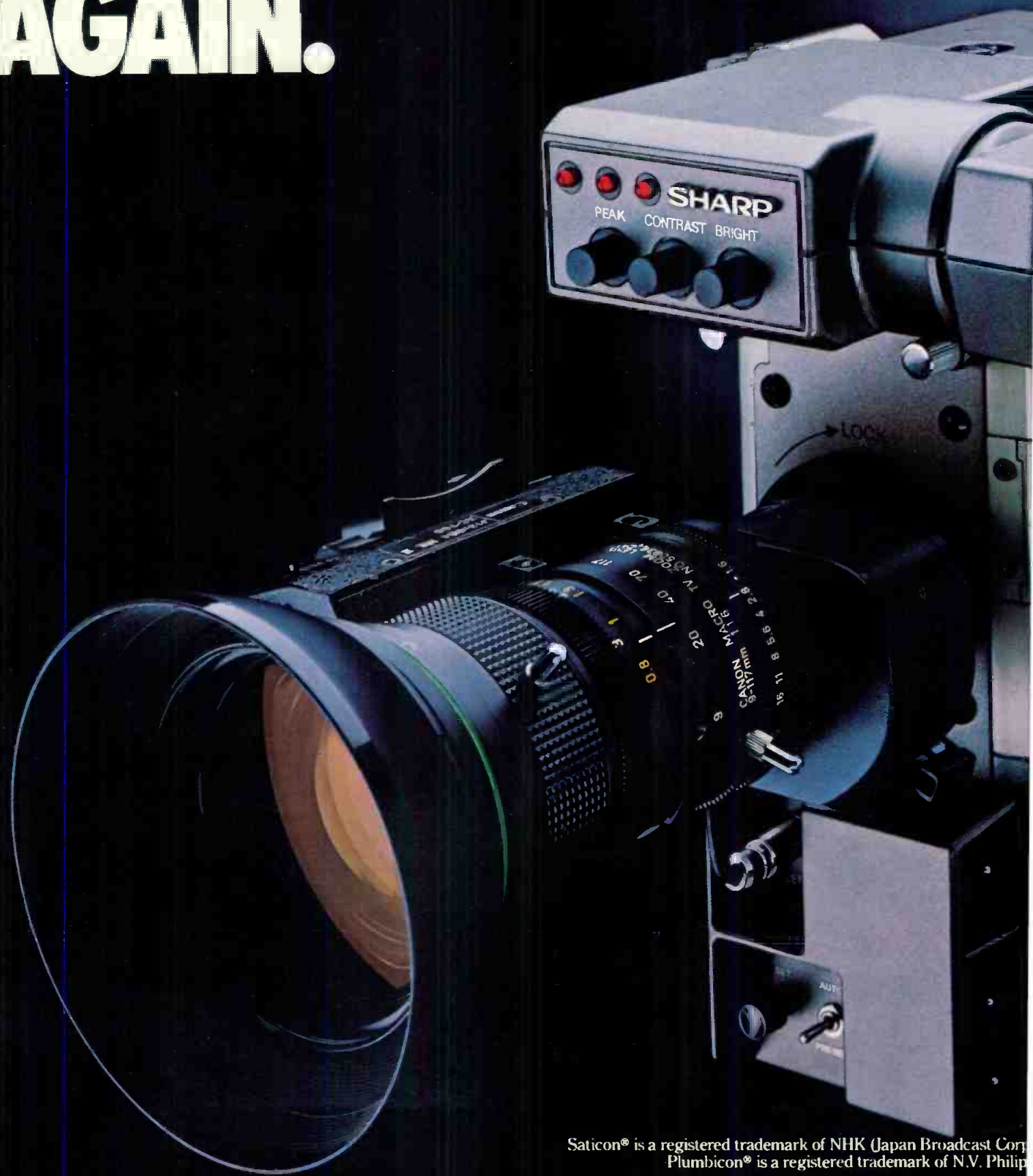

Saticon® is a registered trademark of NHK (Japan Broadcast Corp)
Plumbicon® is a registered trademark of N.V. Philips

-800. SHARP® TAKES OF THE PICTURE.

While everyone else is introducing a mid-priced camera, Sharp introduces a whole new generation.

The Saticon II Generation.

The Sharp XC-800 is the first camera priced under \$13,000 with Saticon II Tubes.

That means it's the first camera in its class that combines Saticon® strengths with a Plumbicon® plus.

So unlike conventional Saticons, you get substantially less highlight sticking, even when you pan across bright lights.

And you still get the higher resolution and depth of modulation Saticons are known for.

But that's just the beginning.

Pound for pound, feature for feature, nothing comes close to the new Sharp XC-800. It's lightweight and perfectly balanced.

And while we're proud of our new on-board computer, and newly designed Remote Operations Panel with serial data transmission and black stretch, the name of our game is more than just features.

It's reliability.

That's what the pros were looking for when we introduced the original XC-700, the first mid-priced camera that didn't perform like a mid-priced camera.

In fact, it performed so well, there are over a thousand of them out in the field today.

And it's been so successful, it's encouraged a rash of new mid-priced cameras.

We encourage you to compare any of them with the new Sharp XC-800.

Between the Saticon II breakthrough and everything else, nobody offers more camera for the money. For more information, contact your local dealer, or write: Sharp Electronics Corporation, Professional Products, 10 Sharp Plaza, Paramus, New Jersey 07652.



SHARP®

FROM SHARP MINDS
COME SHARP PRODUCTS

Mental Health Study Finds Clear Violence-TV Link

Violence on television has an "obvious" connection to violent behavior by children and teens, according to a just-published survey by the National Institute of Mental Health. The report reviews research of the past 10 years seeking to determine if a link exists between violent television programs and aggression in young people.

The report asserts, "... television violence is as strongly correlated with aggressive behavior as any other behavioral variable that has been measured."

NAB spokesman Shaun Sheehan disagreed with the report, commenting, "In the programming that's been developed over the past six or seven years for children, violence as a theme has been screened out and positive role models are being portrayed. A lot of the material out there is old, and according to some people's definition it's violent.

But we feel that the product that's been aimed at children over the past 10 years has been commendable."

Peggy Charren, president of Action for Children's Television (ACT), said of the report, "It's not surprising. The fact that children learn to want sugary foods and expensive toys is widely known, and it's not surprising that they also learn from the messages between those commercials." She went on to say that the answer to the problem was not censorship, but increased viewing alternatives for children, especially on weekdays.

"The result of this study should be that broadcasters feel ashamed of themselves—not that they're offering violence as a diet, but that they're not offering children much else," Charren asserted. "Secondly, we think it should be a warning to parents that that box in the living room isn't necessarily a friend of the family. And to Washington it should say that the marketplace doesn't work for children."

CNN-2 Aims for Affiliates as Nets Expand Newscasts

Ted Turner, cable TV's man of action, is taking on the commercial networks with his second all-news cable service, CNN-2, which is looking to sell its programming to network-affiliated television stations across the country. Several affiliates appear eager to buy.

One reason CNN-2 may be attractive to affiliates is that it could give the stations another option if the commercial networks opt for one-hour national news feeds. Stations that object to the lengthened news format—as do many—could counter by dropping the network newscast in favor of a half-hour from CNN.

Meanwhile, the nets were busy expanding their news offerings in other time periods—especially late nights and early mornings—possibly in an effort to make the 24-hour CNN-2 less attractive to their affiliates.

Turner Program Sales, the Turner

ABC's American Sportsman Soars to New Heights

Borrowing a trick from the latest development in sports aviation—ultralight aircraft or "motorized hang-gliders"—ABC's *American Sportsman* took to the skies recently to shoot rare footage of Peruvian condors high in the Andes. The innovative approach allowed pilot/aircraft designer Larry Newman to actually fly with the birds 11,000 feet above sea level. The shoot was for a forthcoming episode, directed by Stuart Goodman.

The aircraft, little more than a go-cart with wings, required a special mount for the Panasonic AK-710 camera to allow Newman to pan and tilt while isolating the camera from the aircraft's considerable vibrations. The mount was designed in cooperation with ABC BO&E at the Lodi, NJ field shop and at the Engineering Labs in New York City. The camera's viewfinder was remoted so Newman could frame his shots while sitting in a normal position in the small canvas seat. A motorized zoom was also rigged.

Because of *American Sportsman* series producer John Wilcox's commitment to ultra-high-quality images, one-inch recording was specified, although weight restrictions absolutely precluded an on-board recorder. Technical manager Jon Partyka was therefore required to rig up an ultra-lightweight microwave link, using a 20-ounce Tayburn 2 GHz transmitter powered by batteries tucked under Newman's seat to help distribute weight. For receivers, Partyka rigged both RF Technology and Terra-Com units, selecting the signal based on both sensitivity and over-

all performance. Newman ended up flying as high as 13,000 feet and as far away as four miles, while a visible image was presented to the ground crew almost all the time on the low-power, 2 W transmitter setting.

The applications of the specialized rig are far greater than this single show, of

course. In some situations ultra-light-weight aircraft might replace blimps and other aircraft to provide aerial shots of almost anything. Requiring an airborne crew of only one, highly fuel efficient, and able to take off from an extremely confined location, the aircraft may open new vistas for all types of program production.

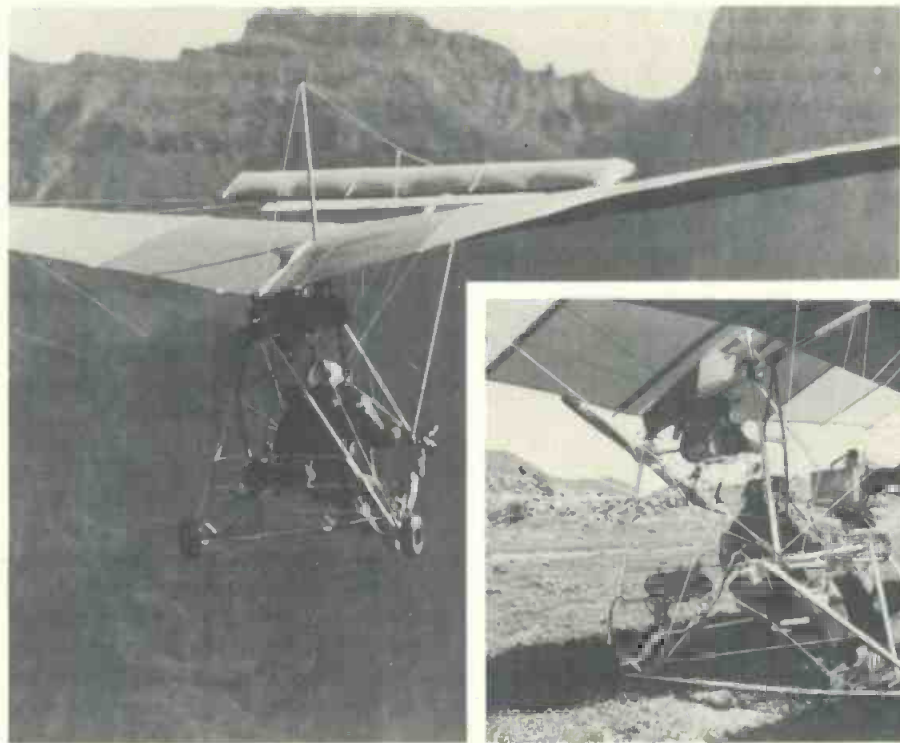

Photos: TRACY KNAUSS

MASTERFUL PERFORMANCE

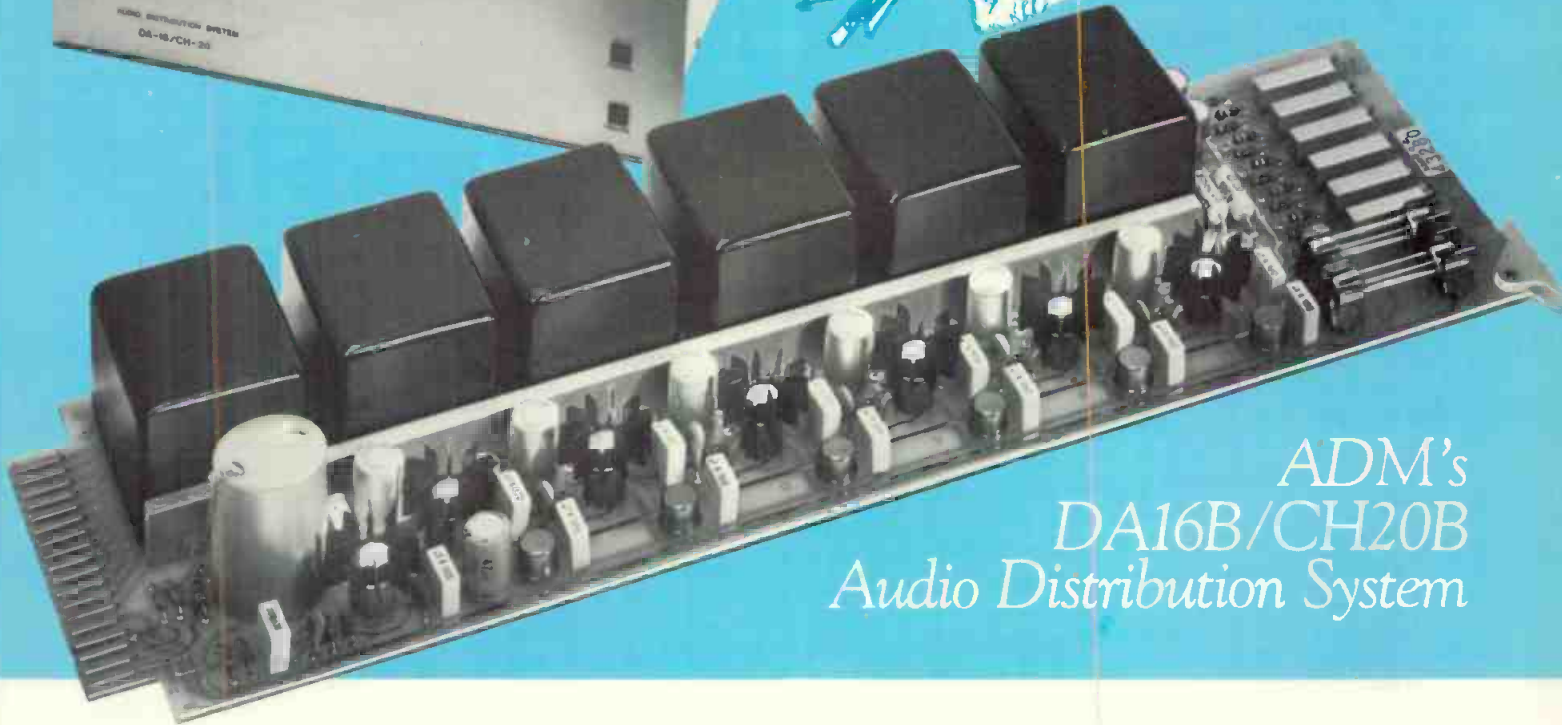

ADM's DA16B/CH20B Audio Distribution System

You are assured of one masterful performance after another because the DA16B/CH20B provides audio distribution of unquestioned reliability. It offers a unique combination of features for exceptional versatility.

- Each amplifier is a one-input, six-output plug-in card.
- The input, and each output is individually transformer coupled.
- Input levels up to +27 dBv; output levels up to +27 dBm before clipping.

- Output amplifiers have individual, front accessed gain adjustment, and a test point.
- Each CH20B will house up to six DA16B cards, and has a complete set of redundant power supplies with automatic changeover.

But probably the most important feature of all is ADM's unexcelled built-in quality—quality backed by a five-year unconditional warranty.

Contact us today for the complete story about the unique DA16B/CH20B system.

ADM[®] *The*
Audio
Company

ADM TECHNOLOGY, INC.

1626 E. Big Beaver Road • Troy, MI 48084
Phone (313) 524-2100 • TLX 23-1114

West Central Sales: (817) 467-2990

West Coast Sales: (415) 945-0181

East Coast Sales: (313) 524-2100

Rocky Mountain Sales: (801) 486-8822

arm that is marketing CNN-2 to broadcasters, quickly signed two network affiliates, WBNS, Columbus (CBS), and KGUN, Tucson (ABC). At press time, Turner Program Sales was reportedly talking to at least 25 additional stations with serious intentions of clearing the news service. Stations that take the service must agree to run at least two half-hours, one between 6:30 and 11:30 p.m. They would pay a monthly fee for the service, but would have four commercial minutes per newscast to sell, making the deal financially advantageous.

Group W, NBC Disagree Over News Poll Findings

A recent study conducted for NBC indicates that viewers would be glad to see network news expand to a full hour—but those findings have been disputed by Group W, which previously had issued study results claiming the opposite.

NBC's poll, conducted over the telephone by Statistical Research, Inc., found 30 percent of respondents in "strong" agreement with the statement, "The national network news

programs which are presently on for a half-hour should be expanded to a full hour." An additional 22 percent agreed "somewhat." The Group W poll, on the other hand, showed 64 percent favoring the present half-hour format for network news, with only 32 percent wanting an hour-long broadcast. That poll, conducted by the Roper Organization, also revealed that of those who opposed the one-hour newscasts, nearly half would rather watch a shorter, half-hour network newscast while another 25 percent would rather watch local news.

Not surprisingly, the differing results reflect the sponsoring organizations' differing stances on the thorny question of network news expansion. NBC, along with the other networks, has strongly urged its affiliates to accept an hour-long newscast despite staunch affiliate opposition. Group W, a large group broadcaster and producer of *PM Magazine*, widely viewed in access time, would be hit hard in the pocketbook if the nets were to expand their newscasts.

Group W Television president Dr. William F. Baker quickly responded to the NBC study, commenting, "Unless NBC's researchers were meticulous enough to ask a real-world question of its respondents—that is, ask the public what it was willing to give up for an extra half-hour of network news—we would say the NBC findings beg credulity." He said Group W continued to view the Roper findings as "irrefutable."

The NBC study also asked respondents to rate the quality of news and entertainment programs. News programs did well, with early-evening network news and local news rated excellent by 31 percent and 25 percent, respectively. Just two percent called either category poor. On the other hand, only four percent rated entertainment programs as excellent.

Arbitron Study for CPB Shows Audience Attitudes

High ratings are one hallmark of programming success, but a new study by Arbitron indicates that audiences think highly of many shows with lower numbers.

The study, performed at the bidding of the Corporation for Public Broadcasting, was conducted last November in 20 markets nationwide; results were issued shortly before press time. Over 2800 participants kept diaries of their television viewing, recording what programs they watched and whether they found the shows "entertaining," "informative," "useful," or "different from other programs." The category

The Wireless Intercom System designed for your specific needs

The Cetec Vega Q System fulfills the demanding applications of motion picture, broadcasting and stage production communications. Sound and camera crew cuing, stunt coordination, sound program monitoring, etc. can be achieved easily without running cables.

Features

- Can interface with wired intercom systems such as RTS, Clear-Com, David Clark, four wire, etc.
- Operates simplex or duplex with up to 6 walking units plus 1 plug-in unit (at the base station, which can include a wired-intercom interface).
- Operates in the VHF high band, 150 to 216 MHz, for minimal interference.
- Usable with commonly available headsets (electret or magnetic).



Cetec Vega

Division of Cetec Corporation
P.O. Box 5348/El Monte, CA 91731/(213) 442-0782/TWX 910-587-3539
In Canada: A. C. Simmonds & Sons Ltd.

Circle 109 on Reader Service Card



Dual channel mix



Character Flip/Rotation

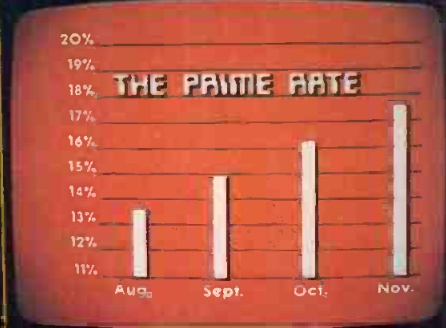

Charting capability

Team	W	L
Philadelphia	15	3
New York	12	4
Boston	10	5
New Jersey	8	11
Washington	7	11

Static headline, changing copy



Keyboard logo compose

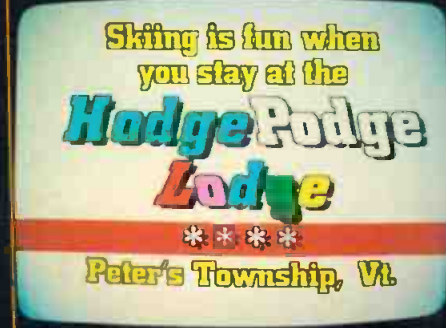

Left and right italics



25% and 50% character reduction

State Senate 5th District 20% Pcts.			
✓ Ward	D	99,876	39%
Roberts	R	84,756	34%
Jameson	I	67,543	27%

WEZY-TV Channel 6

Computer Election Interface

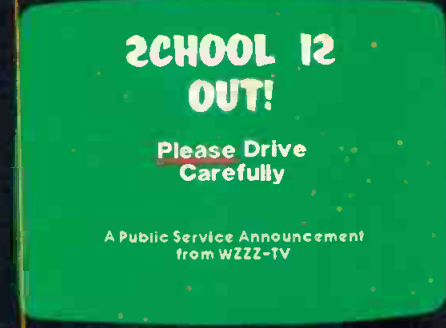

Character reversal

Many of our capabilities aren't even options on other graphic generators.

Which is the do-all, top-of-the-line graphics generator?

It may not be the one you think it is. Unless you specify the D-8800 Graphics Generator System from 3M.

It's the graphics system that gives you almost every creative capability you could want.

Such as the features you see above, photographed from a monitor using graphics generated from the D-8800 keyboard with no external hardware. Including dual channel mix. Ten roll and crawl speeds. Eight mask positions. Both horizontal and vertical autocentering. Character reduction and



italics that give you hundreds of fonts to create and store.

And much more.

Plus the D-8800 talks to you in plain English, at the keyboard. Not in codes that so often take weeks, even months to learn to decipher.

Call 3M today at 612-733-8132 and ask for a demonstration. You'll quickly discover the D-8800 is your only real option. Or write on your letterhead to: Professional Audio Video Equipment/3M, Bldg. 223-5E/3M Center, St. Paul, MN 55144. In Canada contact 3M Canada, Inc., P.O. Box 5757, London, Ontario, N6A-4T1.

3M hears you...

NEWS

ries were intended to measure whether public television was fulfilling its mission of providing high-quality, diverse, innovative programming.

Of the four qualitative scales, the "entertaining" scale most closely correlated with show ratings. Eight of the 10 most "entertaining" shows were commercial TV offerings, including such favorites as *M*A*S*H*, *WKRP in Cincinnati*, *Diff'rent Strokes*, and *Barney Miller*.

The tables were turned in the "informative" category, however, with eight of the 10 most-mentioned

shows running on public airwaves. The two commercial series that placed were ABC's *Nightline* and CBS's *60 Minutes*; public TV shows included *Nightly Business Report*, *Nova*, and *Wall Street Week*. In the "useful" category, too, eight of the top 10 shows were public offerings.

In the "different" category, four public television shows placed: *Odyssey*, *Great Performances*, *Cosmos*, and *Sneak Previews*. On the commercial side, *Hill Street Blues* ranked highest on this scale.

Arbitron's Joseph Philport, who

served as project manager for the CPB study, claims the project was the first time a major audience research company had simultaneously measured viewing behavior and programming evaluations. He notes that inclusion of the evaluations did not significantly decrease the return rate.

Wasilewski Resigns After 17-Year NAB Presidency

The much-rumored resignation of NAB president Vincent T. Wasilewski became a reality April 27 when the association leader formally announced plans to step down.

While an exact date for his departure has not been determined yet, Wasilewski said it would be closely tied in to the appointment of a successor. A search committee is being appointed by the NAB Executive Committee.

Replacing Wasilewski will not be an easy job. Wasilewski first joined the organization in 1949, and became president in January, 1965. Possible successors, according to some observers, include John Summers, NAB executive VP and GM, and Donald Thurston, a former joint board chairman and president of Berkshire Broadcasting Co. Richard Wiley, former FCC chairman, may also be considered, some say.

Wasilewski said that the "extremely heavy travel and public appearance obligation" of his post was one factor in his decision. He will practice communications law in Washington after leaving NAB, at the firm of Dow, Lohnes & Albertson.

Curtain Falls for WNAC; Other Licenses in Danger?

RKO's long battle to retain control of WNAC-TV, its Boston VHF outlet, has ended as the Supreme Court has refused to review the FCC's decision denying renewal of the license.

The court's decision clears the way for WNAC's takeover by NETV, which was awarded the license last February (see *BM/E*, April 1982, p. 16). NETV came about through the merger of two groups that had separately challenged WNAC's license: Community Broadcasting of Boston and the minority-controlled Dudley Station Corp.

Meanwhile, challengers are poised to fight for KHJ, RKO's Los Angeles VHF. Fidelity TV, Inc., has already petitioned the Supreme Court to disqualify RKO as licensee for KHJ and install Fidelity in its place. A ruling is expected this month. Other hopefuls for the KHJ tag include KCET-TV, which would like to switch from its present UHF slot, and City of Angels Broadcasting.

GEOFF MENDENHALL
 JOHN BURTLE
 JOE ENGLE
 CURT KRING

Thanks!

Sincere appreciation and thanks is what we want to convey. Curt Kring, Joe Engle, Geoff Mendenhall, John Burtle and I wish to extend our thanks to the many broadcast industry friends who stopped by to see our NAB Convention equipment display.

Our rapid growth suggests that our products are meeting broadcasters needs and expectations for optimum performance and reliability.

All of us at Broadcast Electronics look forward to serving you in the future and appreciate the increasing confidence in our company and in our expanding product line.

Lawrence J. Cervon
 Lawrence J. Cervon
 President

BE BROADCAST ELECTRONICS INC.

4100 N. 24th ST., P.O. BOX 3606, QUINCY, IL 62305-3606, (217)224-9600, TELEX: 25-0142

Circle 111 on Reader Service Card

"Midwest and Ikegami put us on top of the world."

Bill Garrison
Vice President, Engineering
Multimedia Broadcasting Inc.

Jim Hart
Vice President, General Manager
WBIR-TV
A Multimedia Broadcasting Station
Knoxville, Tennessee

Hart:

"The whole world is watching the World's Fair in Knoxville ... much of it through the eyes of our cameras. So we had to be sure we had the best cameras and mobile equipment available."

Garrison: "That's why we chose Midwest for our mobile unit and Ikegami cameras. Midwest had recently installed the new master control room at our Cincinnati station, WLWT, complete with six Ikegami studio cameras, without a major hitch. We knew they could deliver the quality products we wanted. And we knew their systems would work ... right!"

Hart:

"Not only that, Bill, but Midwest is one of the largest suppliers of video equipment in the country. So they were able to supply us with everything we needed, direct. On time and on budget!"

Garrison: "World's Fair coverage will be a pleasure with our new Midwest M22 Mobile Unit equipped with Ikegami cameras."

For more information on how Midwest can give you that top-of-the-world feeling with quality equipment and mobile units, call toll-free today:

1-800-543-1584



MIDWEST
CORPORATION

**1021 West 8th Street
Cincinnati, OH 45203**

 A UNR Company

Cincinnati, OH
513-651-1904
Columbus, OH
614-476-2800
Cleveland, OH
216-447-9745
Detroit, MI
313-689-9730
Indianapolis, IN
317-251-5750
Louisville, KY
502-491-2888
Lexington, KY
606-277-4994
Nashville, TN
615-331-5791
Charleston, WV
304-722-2921
Virginia Beach, VA
804-464-6256
Washington, DC
301-577-4903
Charlotte, NC
704-399-6336
Miami, FL
305-592-5355

Circle 112 on Reader Service Card

www.americanradiohistory.com

NEWS

Back in Boston, NETV is planning to change the station's call letters to WNEV when it takes over, probably by the end of the summer. The change will likely mean the loss of jobs for many current WNAC employees, and morale at the station, owned by RKO for 34 years, is reported low.

Ohlmeyer, Nabisco Form Communications Company

Don Ohlmeyer, former executive producer of NBC Sports, has formed

Ohlmeyer Communications Company (OCC), of which he will be chairman and CEO. The new corporation, which is partly owned by Nabisco Brands, will produce programming packages for networks, cable, and pay-per-view TV.

Ohlmeyer will continue his relationship with NBC on a consulting basis under a contractual agreement. It is believed the contract goes through 1984 and prohibits Ohlmeyer from offering any sports programming to the other networks.

The new company, OCC, will devote much of its effort to areas other

than sports, providing pilots and movies to cable and pay TV. The company also plans to produce cassettes for sale to the consumer market. Initially, offices will be located in New York City, and later in Los Angeles.

RCA, Rainbow Apply for Ku-Band Satellites

Two proposals for Ku-band satellite systems have been filed with the FCC, one from RCA Americom and one from Rainbow Satellite, Inc. Both systems would serve business and industry as their primary customers.

RCA's proposal calls for a total of four satellites (one an on-ground spare), with the first to be launched in May 1985. Each would carry 16 20 W primary transponders and four spares; they are designed to operate for 10 years. RCA says the system will go after several markets: distribution of signals to LPTV stations; distribution of educational television; teleconferencing; distribution of voice, data, and television services to hotels, motels, and multi-unit dwellings; and digital electronic mail and digital termination services. The complete systems will cost \$306 million, RCA says.

Rainbow, which hopes to launch its first satellite in late 1985, plans to launch two birds, with a third as an on-ground spare. Its proposed orbital slots—85 degrees and 131 degrees west longitude—will make the signals available to many dishes positioned to receive C-band signals, the company says, and will also counter rain attenuation problems found in Ku-band systems.

An interesting feature of the Rainbow plan is its proposal to link businesses nationwide via the institutional cable, or B-cable, provided by cable systems in many cities. The B-cable ties businesses and institutions within a city together; Rainbow's proposed satellite-cable interconnection will tie together users in different cities for videoconferencing, high-speed data exchange, other video and data communications, and computing functions.

Group W Name Change Reflects New Cable Role

Expansion of its role in cable television has prompted Westinghouse Broadcasting Co. to change its name to Westinghouse Broadcasting and Cable, Inc.

Westinghouse's recent acquisition of Teleprompter—now known as Group W Cable—and its establishment of

DELTA's Newest

The FMC-1 Frequency Modulation Controller



- Controls the Modulation Level of an FM or Aural Television Transmitter
- Up to ± 8 dB Adjustment
- Choice of Single Channel or Dual Channel Unit
- Counters Indicate Positive and Negative Overmodulation
- Four Adjustable Modulation Control Levels and Three Audio Adjustment Rates
- Frequency Response ± 0.5 dB 20-80,000 Hz
- Optional ATS Overmodulation Alarm

DELTA's Industry Standard

The AMC-1 Amplitude Modulation Controller



- Controls Modulation Level of an AM Transmitter
- Compensates for Line Voltage Variations
- Up to ± 8 dB Adjustment
- Counters Indicate Positive and Negative Overmodulation
- Seven Adjustable Modulation Control Levels and Three Audio Adjustment Rates
- Frequency Response Typically ± 0.1 dB Up to 30 kHz
- Optional ATS Overmodulation Alarm

DELTA ELECTRONICS

5730 GENERAL WASHINGTON DRIVE
P.O. BOX 11268 • ALEXANDRIA, VIRGINIA 22312
TELEPHONE: 703-354-3350 TWX: 710-832-0273

Celebrating 20 years as the leader in RF Instrumentation.



Progress by Design

Videotek's philosophy is to progressively design & refine the quality, function, and reliability of our products, and to provide equally aggressive service after-the-sale.

Videotek's state-of-the-art TSM-5A Waveform Monitor and VSM-5A Vectorscope reflect this on-going commitment, with such innovative features as Internal Graticule CRT for precise parallax-free signal analysis, and Non-Glare Shields to eliminate distracting ambient light. TSM-5A also includes selectable 1H mode for easy one-line viewing, and 0.5 μ s/div scan rate for the most accurate time-base measurements.

Our popular Studio picture monitor includes, as standard equipment, the features found on monitors costing twice as much: A-B Split Screen, Selective H-AFC, High Voltage Regulation, ACC-Defeat, Preset Controls, Pulse Cross, Underscan, External Sync plus more.

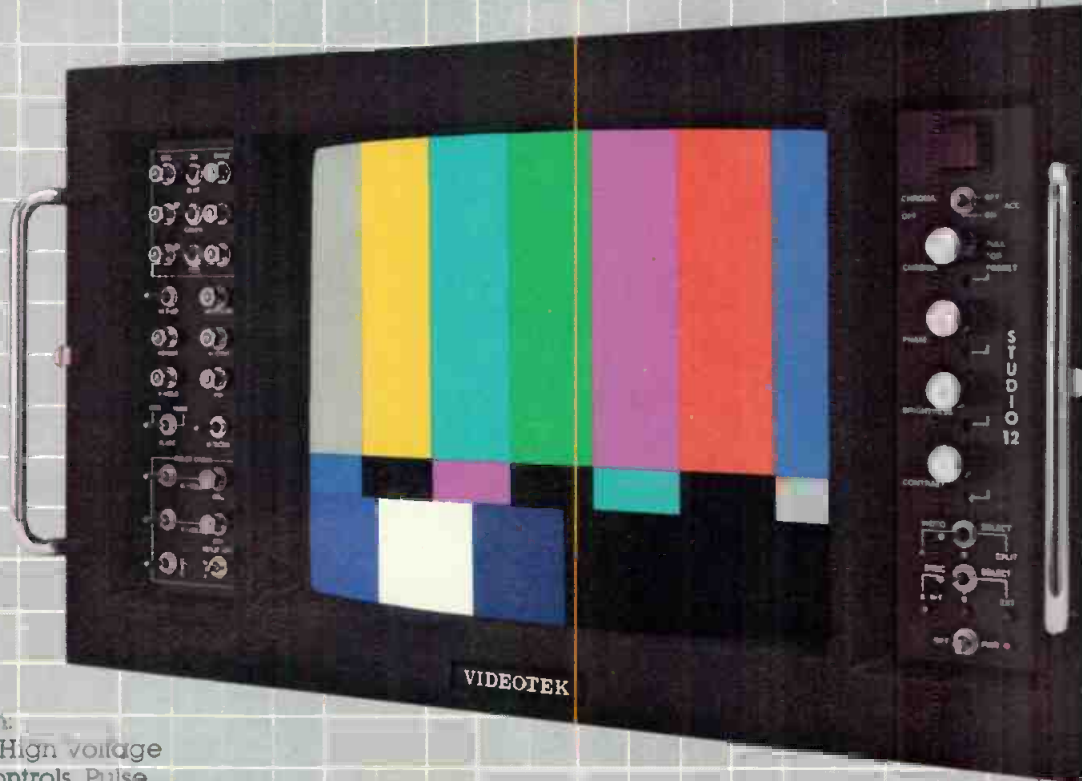

(all available in PAL standard)

In only 7 years, Videotek has become an industry leader. We design and build more sizes and configurations of color monitors than anyone—worldwide! And our 1981 "Distinguished Video Industries Service Award" stands as a testimonial to our commitment to your needs.

Now that's Progress...by Design.



**VIDEOTEK
INC.**

NEWS

Group W Satellite Communications have pushed it into the forefront of the cable industry, the company says, and the new name is intended to reflect the broader outlook.

Group W Satellite Communications offers Satellite News Channels 1 and 2 (both 24-hour all-news channels, coproduced with ABC Video Enterprises), the Disney Channel, and the Nashville Network. Group W Cable is the country's second largest multiple system operator, with over 1.7 million subscribers in 33 states.

In addition to its cable interests,

Westinghouse Broadcasting and Cable, Inc. owns one UHF and five VHF net affiliates, seven AMs, and five FMs. Its production arm, Group W Productions, produces several popular shows including *PM Magazine*.

Another broadcaster moved deeper into cable as Taft Broadcasting teamed up with Tele-Communications, Inc., described as the nation's leading MSO, to buy Plains Communications. Plains is the 39th largest MSO, holding 23 cable systems in five states, with a total of over 90,000 basic subscribers and about 35,000 pay subscribers.

Fire Fails to Flatten Huntsville TV Station

A Huntsville, AL, television station was on-air live just 18 days after a fire completely destroyed its facilities, thanks to help from other local stations, its sister stations, and its suppliers.

Fire broke out as WAFF-TV was preparing for its 10:00 p.m. newscast last March 24. Firefighting efforts were seriously impeded by a lack of water—the hydrants near the 1980 facility had never been hooked into the municipal water supply.

The massive recovery job was aided by loans of equipment and facilities from neighboring stations and other stations owned by WAFF's licensee, American Family Corp. of Columbus, GA. Fortunately for the NBC affiliate, RCA had a Ch. 48 transmitter on the assembly line at the time of the fire and was able to reroute it to Huntsville because of the emergency. The station set up temporary offices at the local educational television station and built a temporary transmitter building on the destroyed site within a few days.

Damaged least of all were the station's business operations—all local and national orders and contracts were in the DCC BIAS system in Memphis, and DCC was able to get WAFF's system running again in five days.

"Everyone has been terrific in helping us get back up to speed," says Joe Goleniowski, WAFF's VP and GM. "The fact that our commercial spot inventory was preserved by the BIAS system saved us from tracking down orders and contracts all over to reestablish an accurate program log."

A similar tale of woe in Norman, OK, had a similar happy ending as KNOR-AM returned to air just three days after a devastating fire destroyed its transmitter room and most of its studio. Harris Corp. was able to supply the station with a new transmitter, audio console, cart machines, and processing equipment two days after the fire, allowing the station to work out of one undamaged room in the studio facility.

Errata

In our April issue, the discussion of new audio developments at the SMPTE Winter Conference in Nashville inadvertently overlooked Studer Revox, which showed both multitrack ATRs and its post-production synchronizer.

Also in April, the Performer mobile teleproduction truck (described in "Convoy!" p. 41) was engineered and built by the engineering staff of AVT Television Productions, headed by Curtis Allin. Lerro Electrical Corp. supplied the equipment and engineering assistance.

S M P T E . . . S I M P L Y

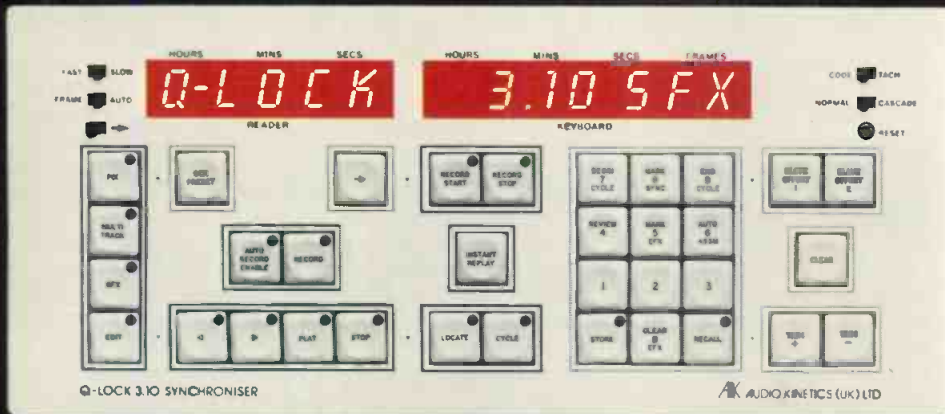

THE Q-LOCK IS JUST THIS SIMPLE:

We supply a complete Audio Post Production Synchronizing system including the interfaces and cable sets for your video, audio and film equipment. The 5-1/4 x 19 inch mainframe also includes a multi-standard time-code generator and any one or all of the following specialized operating programs.

- **AUDIO SWEETENING**
- **MUSIC SWEETENING**
- **ADR/LOOPING**
- **TELECINE**
- **FILM DUBBING**

It's too simple for words.

Call Audio Kinetics now.



AUDIO KINETICS

4721 Laurel Canyon Boulevard, Suite 209

Nortn Hollywood, California 91607

213/980-5717

Toll Free outside of California

800-423-3666

Telex—194781

Hitachi-5 Competition-0

That's the score in one-inch VTR technology.

We've gone the first generation of TYPE C machines *five* better... to help you get all the potential of one-inch out of your video installation. Here's what the competition *doesn't* give you.

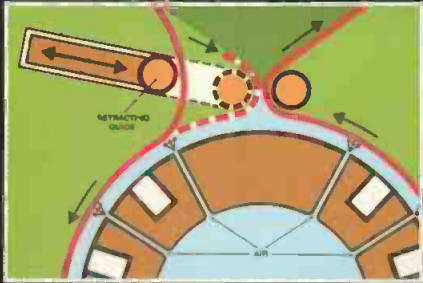

• Tape guide retracts for threading ease • Air drum eliminates head contact in shuttle/standby modes

1. Retracting Tape Guide

Retracts for unequalled ease of threading; repositions with one micron accuracy for up to two million threadings. Provides the reliability of a quad thread system in a one-inch format.

2. "PRO" Tape Path

The protective reverse oxide ("PRO") configuration of the tape path means *only* the video and audio heads touch the oxide surface. All other transport mechanisms guide the tape by its reverse side. Result: noticeably reduced dropouts; longer tape life.

3. Instant Head Replacement

Pre-aligned head design permits easy replacement of video heads in three minutes. No adaptors or jigs; no adjustments required.

4. Audio and Video Confidence

The others only let you *see* what you're taping. We let you *see* and *hear* everything being recorded...simultaneously.

5. Non-contact Tape Shuttle System

In shuttle and standby modes, tape rides on a cushion of air. Increases head and tape life immeasurably. Cuts frictional

resistance, yielding shuttle times of only 80 seconds end to end.

We could go on. With impressive features like microprocessor control; broadcastable slow motion; one-touch shuttle and jog; front access circuit boards; audio spot erase; and on and on. But why run up the score, when it's already no contest? See the Hitachi HR-200, it's equally impressive portable HR-100 model, and companion TC-200 Time Base Corrector.

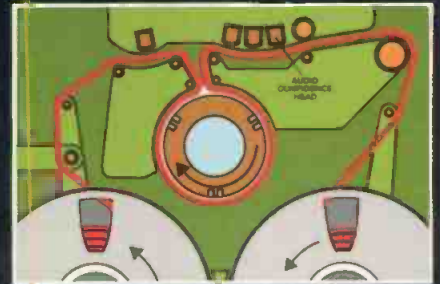

• Full audio and video confidence
• "PRO" tape path reduces dropouts

HITACHI | HR-200



HITACHI
Hitachi Denshi America, Ltd.

Tomorrow's Technology Today

175 Crossways Park West, Woodbury, N.Y. 11797 (516) 921-7200

• New York • Chicago • Los Angeles • Atlanta • Cincinnati • Dallas • Denver • Seattle • Washington, D.C.

Circle 116 on Reader Service Card

PROVEN PE

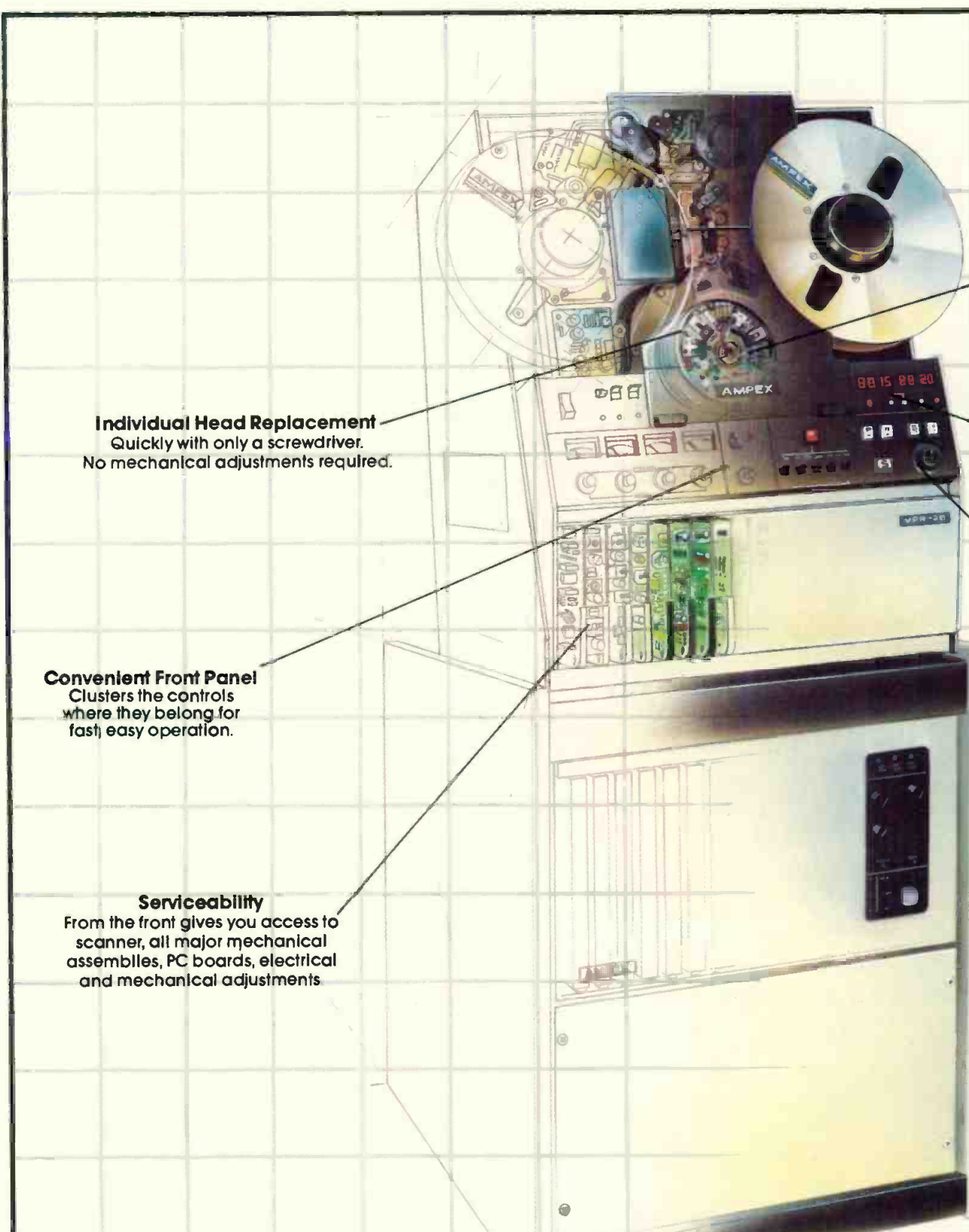

Individual Head Replacement
Quickly with only a screwdriver.
No mechanical adjustments required.

Convenient Front Panel
Clusters the controls
where they belong for
fast, easy operation.

Serviceability
From the front gives you access to
scanner, all major mechanical
assemblies, PC boards, electrical
and mechanical adjustments.

PERFORMANCE

Why the Ampex VPR-2B is the world's most popular video tape recorder.

With over 4000 machines in use, the Ampex VPR-2 Series is without question the most widely acclaimed line of VTRs in broadcasting history. Outstanding performance and simple operating features, backed by a global network of parts, service and training, are just a few of the reasons why.

Ampex leadership began with technical innovation. You'll find the highest standards of design, production and quality control in every VPR-2B. And today, after more than 25 years of dedicated service to the television industry, Ampex continues to lead the way in providing high quality, reliable tools to the video marketplace.

As Ampex leadership started with outstanding products, it continues with the strongest worldwide service

support. With Field Engineers on call and an extensive computerized parts network, you get immediate answers to all your video questions. And each year, more than 2000 students throughout the world go through comprehensive product training at Ampex centers. There are more people skilled on Ampex VTRs than on any other video recorder in the world.

But the VPR-2B is more than just the dominant force in the video

business. It's a part of the Ampex tradition. A tradition born of technical innovation, product reliability and proven product performance. And it's a name you can count on. Call your Ampex representative, or write Ampex Corporation, Audio-Video Systems Division, 401 Broadway, Redwood City, CA 94063 (415) 367-2011. Sales, spares and service worldwide.



AMPEX TOOLS FOR TOMORROW

Ampex Corporation • One of The Signal Companies 

Circle 117 on Reader Service Card

AST® Automatic Scan Tracking
Delivers disturbance-free transitions between play, slow motion and still frame modes.

Frame-Accurate Editing
Results from the VPR-2B's precise tape timer and search systems, AST® and simple edit controls.

Operational Convenience
With continuously variable slow motion instantly available.

NEWS BRIEFS

Katz Broadcasting Co., a subsidiary of Katz Communications, has increased its broadcast holdings with its purchases of **WDBO-AM/FM** and **WSYR-AM/FM**. WDBO, Orlando, FL, was owned by The Outlet Company; WSYR, Syracuse, NY, was owned by the Newhouse Broadcasting Corp.

Acquisition talks between Outlet Co. and the Coca-Cola Co. have been formally terminated. The company is still seeking a prospect for merger or acquisition. Heftel Broadcasting Corp. is selling its **WXKS-AM/FM**, Boston, to executive Rich Balsbaugh for \$15 million.

The Amaturio Group has purchased **WDRQ-FM**, Detroit, from Charter Radio Division for \$5 million. Malrite Communications will purchase **KJOI-FM**, Los Angeles (owned by Milt Maltz) for approximately \$21 million and Heftel's **WLUP-FM**, Chicago, for \$10 million. General manager Bob Dickey, together with Pittsburgh exec Richard Scaife, has purchased Taft Broadcasting's **KQV-AM**, Pittsburgh, for \$2 million.

The FCC has refined its procedure for choosing among applicants for the same call sign. Normally, the choice goes to the first applicant; when applications are received the same day, the Commission says it will assign the requested call to the applicant with "the longest continuous record of broadcasting operation under substantially unchanged ownership and control." International EXPO Information Broadcasters has been granted an experimental license for Ch. 7 in Knoxville, TN. The special station, brainchild of broadcast consultant Edward M. Johnson, will provide information on local accommodations during the World's Fair. The Broadcast Designer's Association has established a graphics library at Kent State University, Kent, OH. The Broadcast Designers' Association Collection will contain materials submitted to the group's annual competition, among other items.

Through an agreement with National Christian Network, Sheridan Broadcasting Network will begin satellite distribution of its programming this summer, utilizing a 16 kHz stereo sub-channel on NCN's Satcom 4 transponder. Mutual Broadcasting system has taken delivery on a fourth SCPC satellite channel on Westar 4. The additional space will give added distribution flexibility and allow stereo broadcasts with minimal interruption of basic net services. The net has signed a number of new affiliates, including WGN, Chicago (as a special sports affiliate); WTBO, Warwick, NY;

KWDE, Montrose, CO; KFOX, Redondo Beach, CA; WVAB, Virginia Beach, VA; WMRK, Selma, AL; and WMOC, Chattanooga, TN. . . . RKO Radio Networks and *Newsweek* magazine are coproducing a weekly radio newsmagazine, *RKO Presents Newsweek*, to air Sundays from 7:00 to 8:00 p.m. Eastern time. . . . CBS's new young adult radio net, RadioRadio, boasted over 70 affiliates—including stations in all the top 10 markets—at its kickoff date this spring.

The Society of Broadcast Engineers has formed a National SBE Frequency Coordinating Committee, which plans to organize SBE chapters nationwide as publishers for the database for frequency coordination. The organization has added an entry level to its certification program and has extended the

BUSINESS BRIEFS

Video camera manufacturer CEI has been acquired by Panavision, supplier of film cameras and accessories. The two companies make the Panacam electronic cinematography camera, and announced the Foton-1 studio camera at NAB. . . . Harris Corp. has delivered its IRIS digital still store system to WGN-TV and to WTVD, where it will be used for news and weather. Pulitzer-owned KETV has purchased two 35 kW VHF TV transmitters from Harris, valued at \$727,000. . . . WWAY in Wilmington, NC has taken delivery of RCA's 100th G-line transmitter. Other RCA equipment purchases include Jimmy Swaggart Association's acquisition of four TK-47s, two tape recorders, and production and editing equipment. PTL Television Network, producer of Christian programming, has bought \$3 million worth of RCA equipment.

Three former employees of MicMix have purchased 100 percent of the company's stock as of February 20, 1982. . . . Nortronics has appointed the Elias Zinn Entertainment Marketing company to sell and distribute its products. . . . Cameron Communications will consult on a new radio series for Narwood Productions.

Western Broadcast Systems has been appointed distributor for Ross Video in northern California, Oregon, and Washington. . . . The Edge is now being serviced nationwide by the CMX representative group. . . . Audities 2001, a sales representative firm in Denver, has been chosen to represent Crown International in the Rocky Mountain states. . . . EECO has appointed Professional Products distributor for its video products.

recertification deadline for engineers whose certification expired January 1, 1982, to December 31. For more information on either, contact Mary Brush, certification secretary, SBE, P.O. Box 50844, Indianapolis, IN 46250. . . . Videotex '82, the World Conference and Exhibition on Videotex, Viewdata, and Teletext, will meet at the New York Hilton June 28 through 30. For further information contact Meeting Systems, Inc., 286 Fifth Ave., Suite 809, New York, NY 10001, (212) 563-1000. . . . The second annual WOSU Broadcast Engineering Conference will convene July 20 through 22, with 26 papers scheduled so far. For information contact John H. Battison, WOSU-AM/FM/FV, 2400 Olentangy River Road, Columbus, OH 43210, (614) 422-9678.

Ampex has received an order for 17 video production switchers, seven graphic systems, and various other equipment valued at \$1.7 million from TV Manchete in Rio de Janeiro. Northwest Teleproductions has bought over \$2 million worth of Ampex ADO and other video products. RKO ordered 10 VPR-2B VTRs and an HPE-1 editing system for \$1.2 million.

Hitachi Denshi announced that CBS Studio 33 went on the air in January with four SK-110 automatic setup cameras. . . . CBS Radio has concluded its negotiations with Scientific-Atlanta to build and distribute earth stations for the radio network.

KRON-TV in San Francisco has decided to computerize its newsroom with a Basys "News Fury" system. The "Cart Fury" computer has been sold to WOR-AM in New York for automation of in-house carts and the audio feed from UPI.

Global Video has opened a new international services facility in Hollywood, CA, to specialize in international video services and entertainment. . . . Matthews Tulip Crane was used at the 39th Annual Golden Globe Awards. . . . Elcom/Bauer has expanded its facilities for increased business activity, the addition of data processing systems, and for more room for its transmitters.

Megasonics, a newly established company, has come out with its first product, a moving coil cartridge. . . . UREI has expanded its sales force in response to increased sales and continued profits. . . . Dynavector Systems USA has moved to 1721 Newport Circle, Santa Ana, CA 92705 to accommodate increased demands.

Central Dynamics NAB report

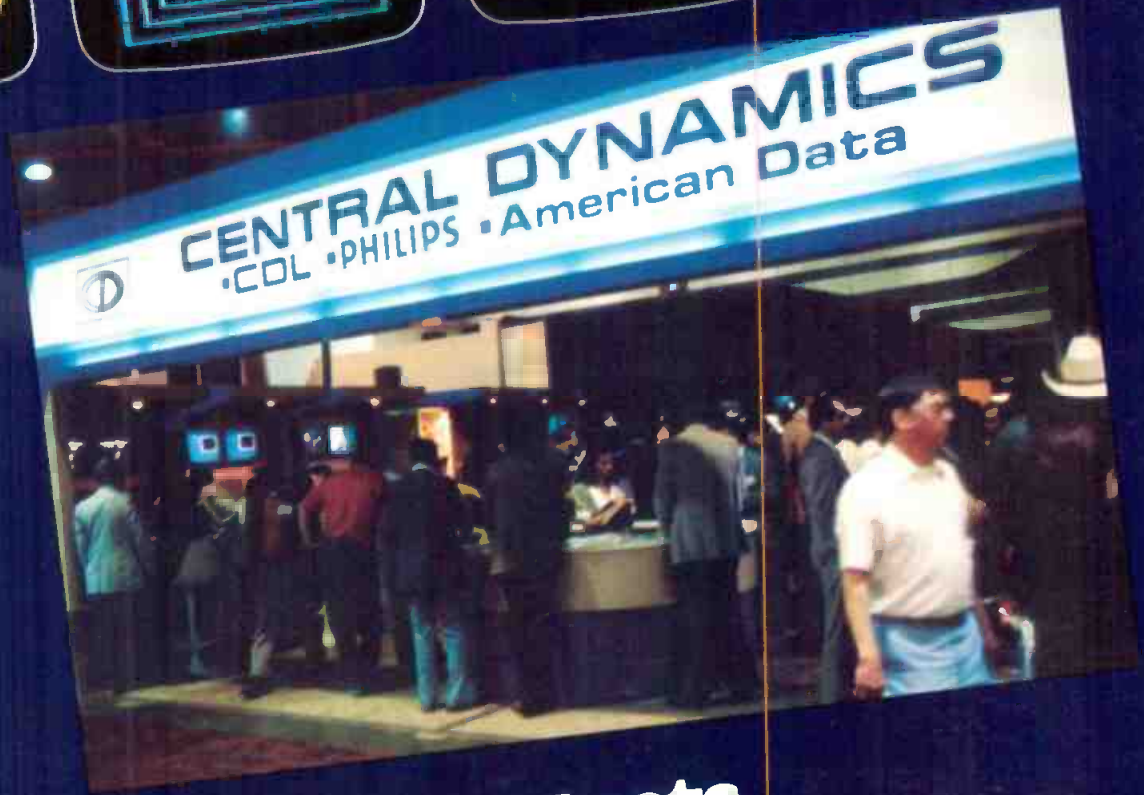

12 new products...
from picture pickup
to transmission.

 **CENTRAL DYNAMICS**
The Broadcast Company for
CDL • PHILIPS • American Data



The new Philips LDK6 intelligent camera...



Mimes, Rudy and Rita, with another star of the camera show... the LDK6.

A new era has been launched with the all new LDK6 field and studio triax camera with "distributed intelligence" to control, report and diagnose so the operator can concentrate on creative camerawork.

For the first time, individual micro-computer and data communication facilities in each of the main system units provide an unequalled degree of intelligence within the system.

Other unique features include:

- Simultaneous multi camera computer controlled setup... partial or automatic.
- Diagnostics for on line anticipatory and off line on-demand fault indication.
- Digital scan correction to ensure consistently impeccable pictures. The picture is divided into 49 discrete areas and each is examined and adjusted which results in a spectacular reduction in corner errors.
- Wide Band RGB video over triax, up to 2 km and without compromise to picture quality.

- Multiple camera settings, achieved during rehearsal, can be stored and recalled instantaneously during program production.
- 4 lens memories to automatically adjust for different lens parameters including back focus. Now lens changes can be made rapidly.
- Built-in diascope so standard lenses can be used including LDK5/25 lenses.
- Either 25mm or 30mm Plumbicons[®] can be selected.
- Two-wire data bus permits easy and economical expansion.

And the cost of ownership benefits are equally as impressive as all the LDK6 features.

...joins the family of other Philips cameras... "state of the art" cameras for tough and specialized assignments.



Philips high technology "workhorse" cameras continue to be the choice of demanding broadcasters for quality pictures, reliability, flexibility and low cost of ownership.

LDK5B and 25B are rugged and reliable high quality cameras. The all triax LDK5B has become a standard for tough remote requirements, and continues to be the first choice for quality field productions. The multi-core LDK25B is a first line studio camera... and is surprisingly affordable.

LDK14S and SL EFP/Studio cameras are ready for any shoot out and comparison of automatic features... and require only a simple adapter for triax conversion. The LDK14SL with Low Output Capacitance (LOC) diode gun Plumbicons* offer an unusually high Signal to Noise Ratio (57dB) and higher resolution.

LDK44 is a new modular 3-in-1 versatile and economical broadcast quality ENG/EFP/Studio camera. Features include a built-in sync generator with outputs and Gen Lock. RGB outputs. 0 to +12dB variable gain, and automatic circuits for white, black, centering and iris... plus bias light, shading, DBC and 2 line vertical contours. No other camera offers these features and flexibility at such a low price.



LDK14S studio configuration.



LDK camera presentation stage.

*For full details send in the
Direct Response Reply Card at
the front of this brochure.*

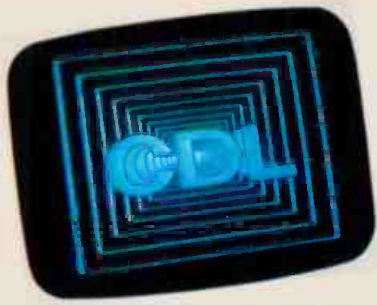

New CD-480 Model 6S... powerful, compact and surprisingly affordable.

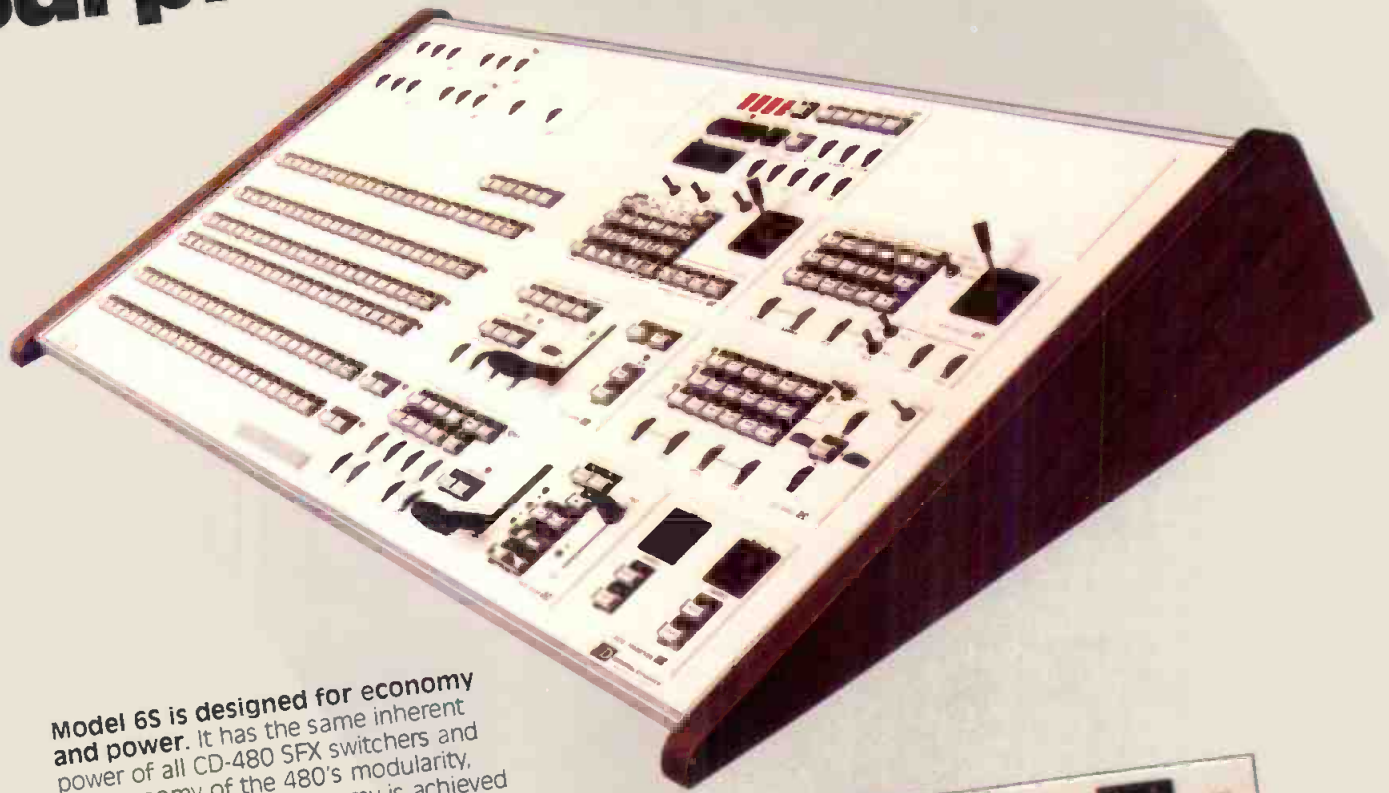

Model 6S is designed for economy and power. It has the same inherent power of all CD-480 SFX switchers and the economy of the 480's modularity, and now additional economy is achieved with the new Program Processor Module that includes Mix, Wipe, Cut, Titling, Key Border and Fade-to-Black facilities that are downstream of the fully equipped Program Mix A and B buses.

The Program Processor operates similarly to the SFX Module... a mix, wipe or cut transition may be performed, changing the Background and Title simultaneously or individually. There is also a separate control for fading any source or composite, sync or non-sync, to black.

The power of the Model 6S may be increased at any time with CD-480 optional production modules that include RGB and Encoded Chroma Keyers, Extended Effects, One Bus Quad, digital video and editor interfaces, CAP and 2 auxiliary buses... many of which can be plugged into the compact 18RU rack electronics.

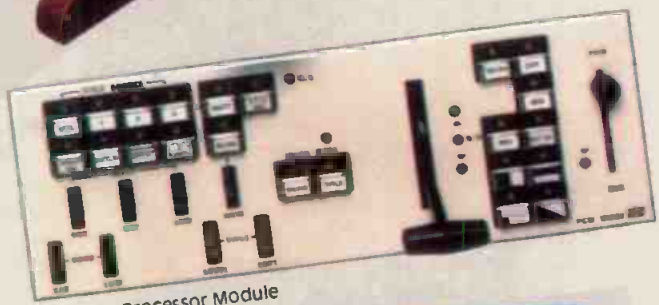

Program Processor Module



All CD-480's feature the powerful SFX Amp. A single SFX can control 4 video sources simultaneously or individually, and without lockout.



Show Stopper!



CDL's 30 live NAB shows were produced by Evelyn Radnai with the CD-480 Model 10 equipped with CAP and digital video effects. CD-480 Model 10 is the largest and most powerful of the 8 Models in the 480 Series.

Evelyn created and demonstrated sensational new visual effects that featured the unique capability of a single SFX to create 2 chroma keys and artistically control 4 video sources.



Evelyn used CAP (Computer Assisted Production) for 2 live, unattended minutes during each show to demonstrate its extensive 'Learn' capability and perform, automatically and rapidly, complex transitions and sequences that required up to 20 preset functions.

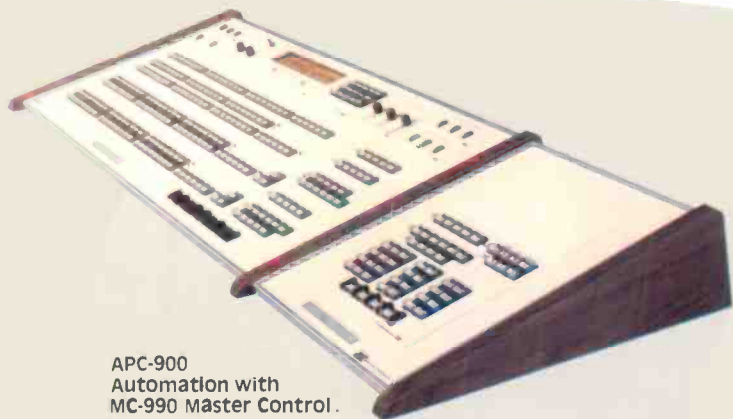

APC-900
Automation with
MC-990 Master Control.

The APC-900 microcomputer systems are modular and easily expanded. The APC-910 (shown above) stores up to 40 events with machine assignments and preroll times; the events are manually put on-air, and the next event is previewed. The APC-920 converts the 910 to a true time system with events automatically put on-air by scheduled or duration time, or manually taken as a cue event. The APC-930 converts the 920 to an external mass memory and interactive communications system with an optional station business computer interface.



2300 Series DA's. A full range of centrally powered DA's with exceptionally high performance specifications include Variable Gain, Equalizing and Clamping video types, and Linear and Regenerative pulse types. All have 6 outputs and the low power requirement (approx 2 watts) permits high density packaging... up to 84 outputs per 3RU frame.



The World's Fair Van. This Central Dynamics Corporation Model D-22 is fully equipped with 3 Philips LDK145 EFP cameras, American Data 2104 switcher, 2 Philips PVR-2 1" VTR's, and associated audio, lighting, production and support equipment on a 30 foot Wolf Coach van.



CDC's new line of 4 standard vans provide maximum versatility and cost effectiveness for the user. All have built-in flexibility and allow for future expansion. They range from 10 feet of production space (Model A-10) with 1 camera to 22 feet (D-22) with up to 6 cameras.

For full details send in the Direct Response Reply Card at the front of this brochure.



The latest American Data 3100 Series Switcher... the 3101-20.

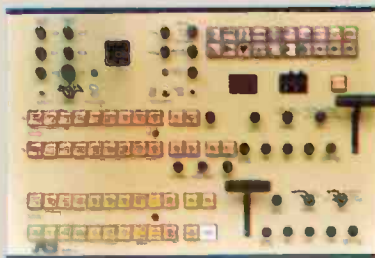
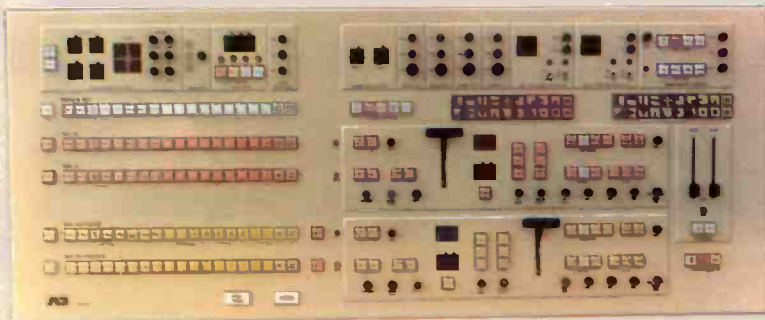
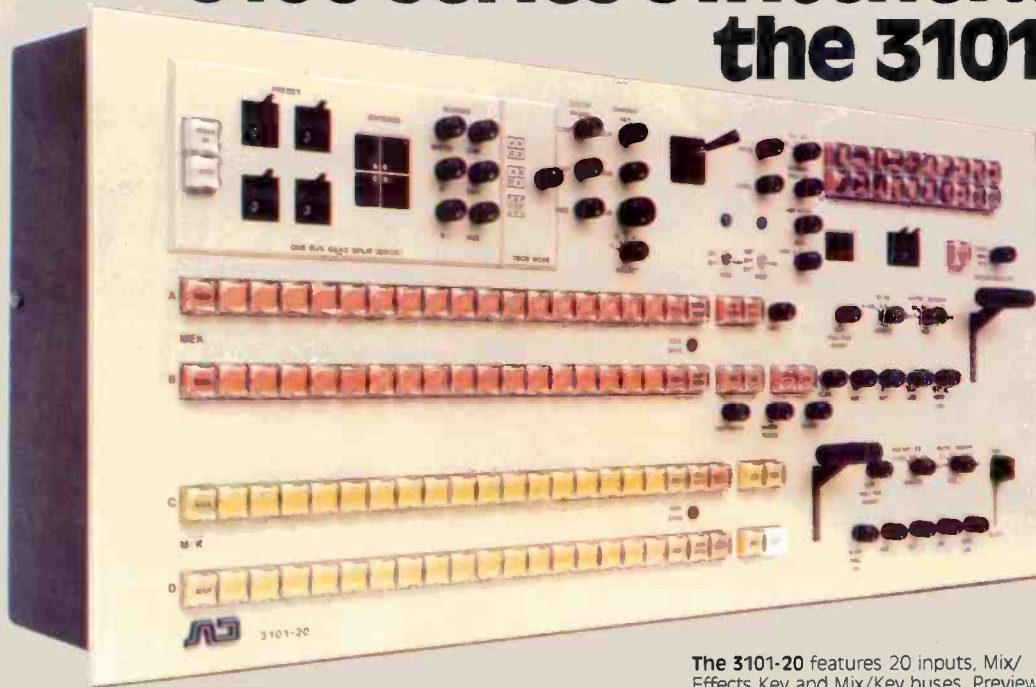

The 3101-20 features 20 inputs, Mix/Effects Key and Mix/Key buses, Preview output switching matrix, Master Fade-to-Black, a variety of optional modules, and all other features of the 3100 Series.

The 3100 Series switchers have a powerful four channel serial processor that performs multiple functions on a single M/E amplifier... functions that require at least 2 M/E's on conventional switchers.

The 3104A's new modular design permits upgrading the switcher simply and economically with 3100 optional modules including RGB and encoded chroma keys. One Bus Quad Split, Key Edge generators, Linear Downstream Mix/Key system with Master Fade-to-Black, and 5 auxiliary buses.

The compact 3101. Compare its performance and price to find out why it is used extensively worldwide for smaller studios, mobile vans and post-production suites. It includes all the facilities required to perform complicated effects programming and can be interfaced to a variety of computer editing systems.



860 Downstream Keyer. This economical stand-alone system adds title keying to the program output of any switcher.

The 860 features the latest in high technology design techniques with a digital matte generator and optional CCD edger.

The keyer includes Master Fade-to-Black and controls for inserting keys with either an edge, shadow, or color outline.

Chroma-Pan™ ... a new dimension for chroma keying.



Chroma-Pan ... considered by many as the most revolutionary device shown at NAB '82.

For the first time an all electronic system permits a chroma key background to accurately travel with the foreground talent. This system simulates a one camera on location action shot that previously was only possible with rear screen projection.



The 5101-20 equipped with a NEC Digital Video Effects unit at the NAB switcher presentation console.



The 2104 installed in the Central Dynamics D-22 World's Fair Van. This model is available with either 10 or 16 inputs and includes 12 special effects patterns with variable softness and borders. The two level keying system permits title keying with edge over chroma key or luminance key over special effects.

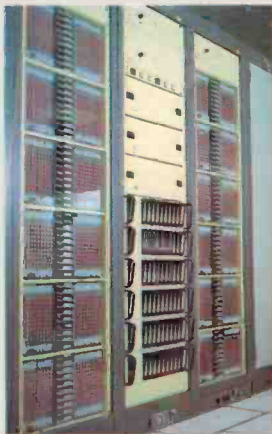

Model 900 Audio/Video Routing Switcher. Over 1000 systems have been installed. The performance of this all solid state, fully expandable system at broadcasters, NASA and major telecommunication networks, has earned it the reputation as "the most reliable routing switcher".

Only two different matrix modules are used (switching and output amplifier); therefore, operational and mechanical integrity is maintained if modules are interchanged within the system.

Parallel, serial, BCD or binary information is used for control, and all necessary decoders and latches are provided to facilitate any method of control from simple pushbuttons to a sophisticated computer system.



800 Series self powered DA's. These video and audio DA's may be installed and operated in the same frame without affecting the quality of either signal. All have 6 outputs and models include distribution, delay, subcarrier, differential input clamping, and equalizer types.

For full details send in the Direct Response Reply Card at the front of this brochure.



Philips/Pye TVT transmission systems.



New super high efficiency Annular Beam Control external cavity klystrons. These Philips/Valvo type YK-1295/96/97 klystrons have an integral control that effectively limits the beam current during the active portion of the picture for substantially increased operating efficiencies... and without signal degradation.

The LDM 1208 55KW UHF Transmitter can also be configured into a 110KW or 220KW transmitter. All use Philips/Valvo high efficiency external cavity klystrons.

Another feature of these transmitters is the LDM 1170 exciter. This IF Modulation solid state system pre-corrects for envelope delay, linearity, differential phase, etc., and models are available for upgrading presently installed transmitters.

Pye TVT's new microcomputer transmitter monitoring and remote supervisory control system. This system is compatible with a variety of old and new transmitters, and can also control transponders and microwave links.

Features include warnings for out-of-tolerance operating parameters, fault detection, performing switching sequences, and automatic analysis and printout of tube electrode current, frequency, power, etc.



CENTRAL DYNAMICS
The Broadcast Company for • **COL** • **PHILIPS** • **American Data**

Central Dynamics Corporation, 900 Corporate Drive, Mahwah, New Jersey 07430 201-529-1550
Central Dynamics Ltd., 147 Hymus Blvd., Montreal, Quebec, Canada H9R 1G1 514-697-0810

For full details send in the Direct Response Reply Card at the front of this brochure.

1982 NAB Show-In-Print

THE BROADCASTING INDUSTRY is alive, well, and kicking—but still somewhat cautious, according to many of the approximately 28,000 broadcasters, exhibitors, and guests who helped make NAB, 1982 in Dallas perhaps “the biggest show on earth.” In addition to the 5500 broadcasters who registered, some 500 showed up at the Convention Center and paid \$50 each simply to tour the exhibits. They, and everyone else in attendance, got more than their money’s worth.

What stands out? Looking at booths from some 460 exhibitors arranged on two floors of the hall (the lower floor was converted from a parking garage), it is almost impossible to single out a single “theme” as has been possible previously. Microprocessors are in increasing evidence everywhere in the industry—from engineering planning to technical automation to business operations to test equipment—and are becoming more sophisticated. In some cases, development work that went into large, computer-controlled systems is beginning to spill back into smaller systems accessible to all broadcasters. More and more digital systems have self-diagnostics to help ease the problem of engineers not yet fully trained in the new technology.

Both sounds and images presented by radio and TV are also increasing in sophistication, with more special effects and production techniques being added to existing systems that also make production more flexible. But signal quality improvements are being made constantly, too, again thanks to the omnipresent microprocessor.

There is perhaps one generalization that holds true for the entire industry: broadcasters are buying equipment again, having held off for the past few years. The reluctance may have been caused by uncertainty that broadcasting was, indeed, recession-proof. Perhaps broadcasters were “waiting for the other shoe to drop,” unwilling to let go of their profits for fear that the industry might come tumbling down. But network revenues were up 13 percent last year and spot sales have never been healthier. Broadcasters are making a profit and are beginning to come out of hiding.

But whereas five years ago everyone was looking for the most sophisticated piece of equipment—the one with the most “bells and whistles”—this year’s mood was different. “Will it last?” was a frequently asked question. “How reliable is it?” was another. Broadcasters are spending, but much more carefully than before, and with an eye to the future and the realization that this may be the last console or camera they can buy for several years.

BM/E’s Show-In-Print NAB report, a tradition since 1965, once again provides the industry’s most comprehensive, reliable coverage of the show. It began last month with our report on Satellites (p. 79). This month the main body of the report contains a comprehensive analysis of both Audio and Video equipment at the show. Next month the report concludes with a discussion of developments in RF and mobile vehicles shown in Dallas, examining systems for both radio and television.

We have made the write-ups as easy to follow as possible, and a complete index of product categories precedes both the audio and video sections. As you read through the report, please feel free to use the **Reader Service Numbers** that follow each section; simply circle the numbers on the **Reader Service Card** to receive more information directly from the manufacturers.

AUDIO report begins p. 37
VIDEO report begins p. 71

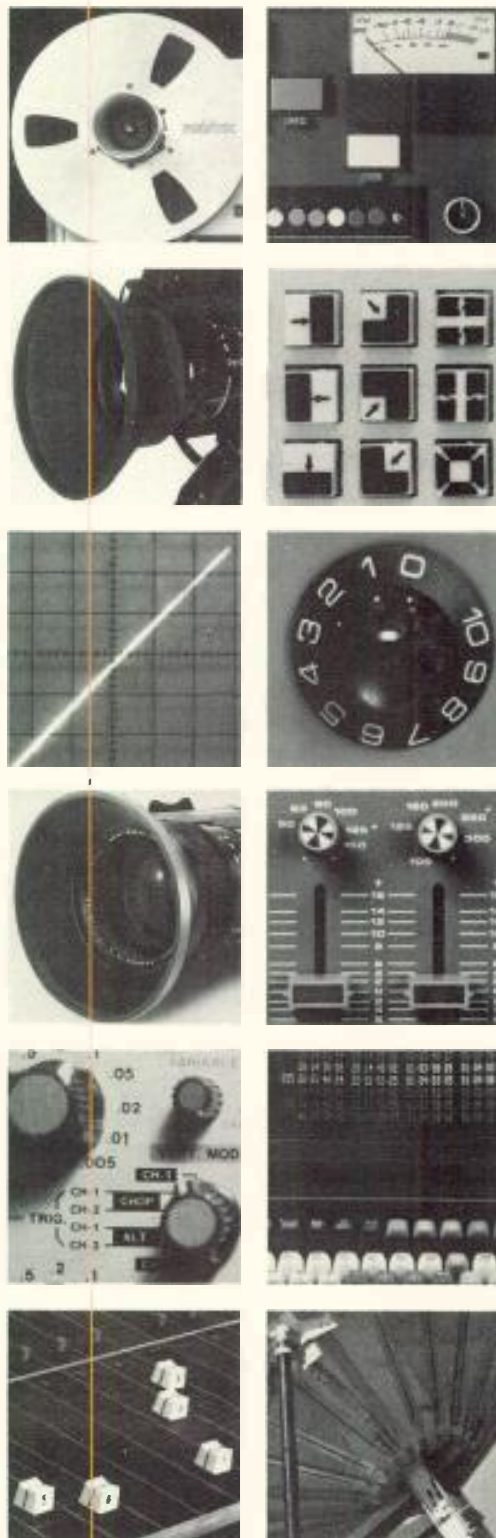



the trendsetters

Unquestionably the industry's standard of excellence in broadcast equipment

Most manufacturers meet industry standards; we exceed them. Our TOMCAT cartridge recorders/reproducers and BMX series of broadcast consoles deliver trendsetting on-line performance in broadcasting systems worldwide, from Boston to L.A., Australia to Great Britain.

TOMCAT: simply the world's finest. Innovative design assures superb sound quality, reliability, and low noise yield more signal, lowest phase error.

BMX, Series II: the ultimate in high performance mixing consoles. These compact units feature proven RF immunity and CMOS remote control flexibility, plus a choice of 10, 14, 22,

and 26 input mainframe configurations. A new mix-minus busses for telephone talk shows. All this in a no-nonsense panel layout! See why TOMCAT and BMX series have made us the industry trademark. Call or write today for free information on our complete line of equipment.



pacific recorders & engineering corporation

1100 roselle street
san diego, california 92121
telephone 714 453-3255

1982 NAB Show-In-Print

AUDIO

Consoles

The trend toward higher quality TV production consoles and portable consoles that can be customized to user specifications continued at the 1982 NAB show. For example, **Harrison Systems** introduced the **TV-3**, a new production console with full multi-track facilities designed with heavy emphasis on stereo sound for television images. There are numerous interchangeable modules for custom applications and an automation interface, compatible with the Melkuist disk-based system or the Valley People's 65K programmer.

One of the highlights in audio sweetening and editing combined with video post-production was the **Quad Eight 248 Component Series** with customized modular capability, including the Compumix III disk editor system for interfacing with video production.

The **Soundcraft Series 2400** with complete audio production facilities and 24 track routing, has an optional automation system for video interface. Two different mainframe sizes were on display.

Rupert Neve's new entry into audio production units was the **51 Series** designed for broadcasters and featuring digital processing for interface with an outboard computer for automation (via fiberoptics, if desired). The entire series is centered on an expandable frame, enabling made-to-order features for any studio.

Also in this category was the top-of-the-line **Model 2400** console from **ADM**, meant for video production. With equalization and preselect available on the inputs, this console is also suitable for on-air applications.

Ward-Beck's featured new console was the **R 1000** radio console, a flexible unit with up to 10 inputs and two

outputs, ideally suited to newsroom or small station use. The company's other studio production and on-air consoles were also displayed.

A brand new broadcast production console was introduced by **LPB**. The **Benchmark Series**, priced at \$17,000, features slide faders, internal cue system, and internal power supply and transformer. It is an update of the **Signature II Series** and is intended as a production console. **Broadcast Audio's** top of the line unit is the **System 20**, a mixer that can sit on top of a desk without recessed mounting and that has dual remote inputs.

Incorporating digital technology, the **Harris Micro Mac** audio console offers microprocessor memory and automatic logging during live operation. Among its programmable attributes are muting assignment of speakers in control room and studios and stop delay for reel-to-reel machines for accurate cueing on program tapes.

The **Eclipse Series** of consoles from **Sphere** comes in three types (A, B, or C), depending on the options or degree of sophistication required. Type A incorporates the most features including the 900 graphic EQ which operates in octave steps with half-octave presence range shift. The series is available with up to 40 inputs and 32 outputs. The **Travis** all-digital touch control faders with no moving parts were displayed by **Sphere**. **Penny & Giles** showed its new **3000 Series** of environmentally shielded faders.

Another development at the show saw console makers offering complete packages with console, furniture, and tape deck layout already assembled. **McCurdy**, with its **SS8650** modular stereo console, which has up to 16 input channels with A/B switching and cue switching, was set up in this way. **Broadcast Audio** used the new **System 14** digital control console as an on-air board in this type of configuration.

Consoles	37
ATRs, cart, reel-to-reel machines, and tape	40
Audio processors	47
Special effects	50
Noise reduction	50
Delay lines	52
Other processors	52
Microphones	52
Intercoms	57
Turntables	57
Amplifying equipment	58
Monitors	58
Remote control, STL, RPU	58
Telco interface	60
Automation, business, and programming	63
Test and measurement	66
Other	66
Satellites	May issue, p. 79
RF equipment	July issue

MCI showed a **studio package** for \$46,000. It includes the **JH-618** console with **HC** and **110B-2** reel-to-reel decks and studio cabinetry. It is set up to accept inputs from an eight-track ATR, two microphones, and cart decks. Also in the system was the **Autolocator III** for cue dubbing. The **JH-500 Series** from **MCI** was displayed and is automation ready.

Pacific Recorders' BMX consoles were fitted into studio cabinetry with cart deck turrets and turntables. The **BMX** boards come with up to 26 various input modules and also the telephone mix/monaural output for talk show formats. On this module, three



Large automated consoles from (clockwise) Solid State Logic, Neve, and Harrison (the TV-3 with TV monitor level indicator).

separate mixes are provided, two for feedback to callers, and the third to feed the callers to the host's monitor or headphones.

Broadcast Electronics showed various consoles with the 10S350, ten mixer with vertical fader (including pre-fader preview), and dual channel output featured in the complete studio setup.

Auditronics demonstrated the Series 200 on-air consoles which receive the plug-in personality EQ card allowing preset equalization of on-air talent.

Clyde Electronics, appearing at its first NAB with complete system packages, introduced a line of **customized production consoles**. The outputs are four groups and stereo out with monitor modules for four track mixdown to two. On-air are four groups in stereo pairs. An equalization function is another feature on the Clyde boards with each on-air personality having a personal code that he can punch into the console.

Ramsa, the professional audio division of **Panasonic**, demonstrated a complete and versatile line of consoles. The portable WR-130 is a small 8 x 2 unit with recording and phono inputs. The WR-8000 Series goes from the

8210 (10 x 4) all the way up to the 8724, which is a 24 x 4 console with two effects modules and effects send. The two echo effects modules are left/right while the send is mono.

Teac's Tascam Productions demonstrated the M16 mixing console with 16 to 24 inputs and eight outputs. The eight main program mixing buses come with submaster faders, and there are two independent stereo mixing buses. **Audiotrack** showed its compact mixing console useful for mobile broadcast production with each of the 16 inputs having balanced mic input, and pad and switch selectable line input. **Interface Electronics** introduced its four- or eight-track consoles with phantom

power, phase reverse, and four cue/echo sends for either pre- or post-fader.

Howe Audio's newly introduced console is the 7500, which has full logic control of on/off cue functions, programmed audio control system, and RF-proof casing. **Trident** announced its Trimix line of compact, expandable consoles with four band equalization on each input. Also standard are separate mic and line gain controls.

The **Cetec Broadcast 8000** console, an eight mix expandable to 16, is the company's top of the line broadcast board and sells for \$10,850 with eight stereo controls. Each additional module adds \$570. **Continental Electronics** displayed the Rock 10 and Mark 8 studio control consoles with a machine control interface to handle start/stop functions for decks and turntables. Along with various other audio products, **Gotham Audio** had the EMT multi-output mix system with 10 to 30 input channels.

On hand too, was a wide range of small mixers aimed at the growing interest in improved audio quality by television and radio ENG crews. One of the most striking field units was **Eela Audio's S 41** mini mixer with four inputs, switchable mic/line levels, and phantom power. The faders are recessed into the body of the mixer to avoid acciden-

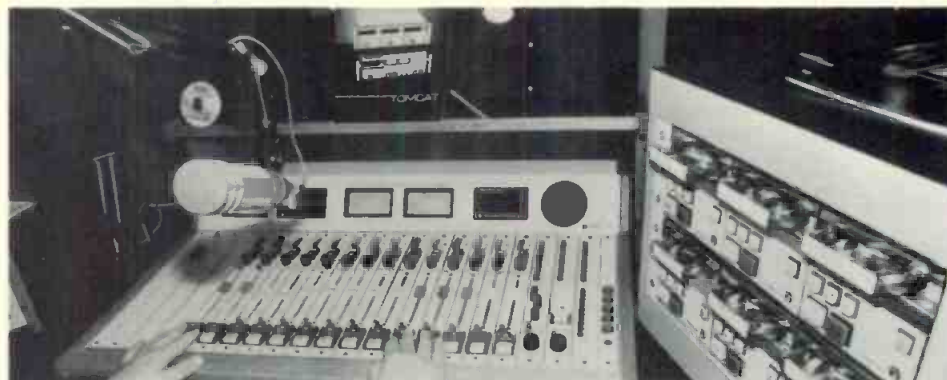

Pacific Recorders BMX console, Tomcat cart.

SIX REASONS WHY MOTOROLA'S AM STEREO SYSTEM IS GETTING SUCH GOOD RECEPTION.

Motorola's C-QUAM® (Compatible Quadrature) AM Stereo System is attracting the attention of broadcasting executives.

Probably because no other AM Stereo system has all that the C-QUAM system offers:

- 1) Full modulation capability over the whole range the FCC allows (from +125% to -100%).
- 2) No monaural distortion increase.
- 3) Full coverage in monaural and stereo.
- 4) Causes no clicks or pops.
- 5) Full frequency response.
- 6) Lease plan.

These and other C-QUAM system features are completely explained in our free brochure "AM Stereo. The Answer to the Marketplace Decision." Send in the coupon for your own copy. Or call Dick Harasek, Motorola, Inc. P.O. Box 95334, Schaumburg, Illinois 60195 (312) 576-3591.

Dick Harasek

Manager, Advanced Technology Products

Motorola, Inc. P.O. Box 95334

Schaumburg, Illinois 60195

Please send me a copy of your free brochure: "AM Stereo. The Answer to the Marketplace Decision."

Name _____

Title _____

Station/Group _____

Address _____

ZIP _____

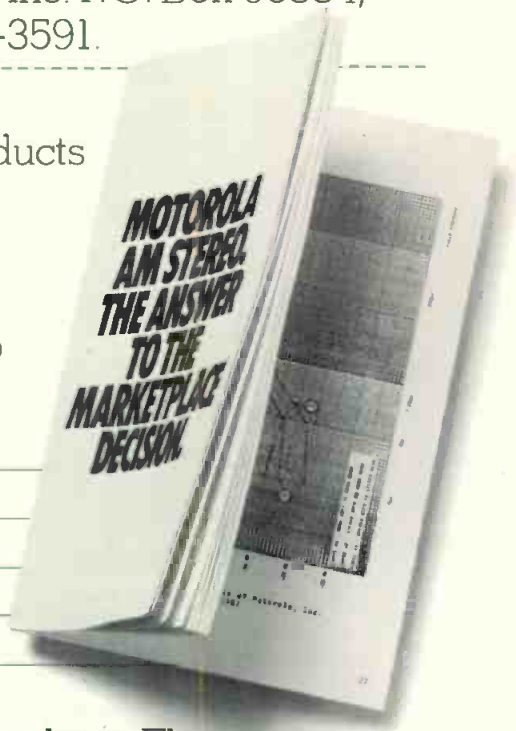

MOTOROLA A World Leader in Electronics

©1982 Motorola Inc. Motorola, C-QUAM, and  are registered trademarks of Motorola, Inc.

Circle 110 on Reader Service Card

www.americanradiohistory.com

Studer 69 Series, 300; Audio Developments AD045 Pico Plus, 301; Tweed Audio BC 102/104, 302; Audio-Technica ATC units, 303.

ATRs, tape

Paralleling the developments in consoles, audio tape recorder manufacturers showed various decks targeted for TV audio use, portable applications, and improved radio specifications.

There were some surprising new developments in carts and cart decks. **Ramko Research** has upgraded its **PhaseMaster** cart deck with crystal-controlled dc servo motor and machined head stack. An oscilloscope adequately demonstrated the PhaseMaster's improved stereo phase stability. It is available in stereo record/play and stereo playback units.

Ampro/Scully, too, showed a recent version of the Series 8300 three-deck cart reproducer and the 4500 stereo cart series. **Broadcast Electronics** displayed many different lines of cart machines including the 5300B plug-in multi-deck with Nortronics Duracore heads. Also on hand were the Series 2100, accepting A, B, or C size carts, and the 3000 Series with wide dynamic input range and modular design.

International Tapetronics Corp., recently acquired by 3M, featured the new **99B** cartridge machines, demonstrating the 8048 microprocessor system controlling all electronic functions. The ITC RP Series of recorder/reproducers was shown, including the RPD with a third head and two separate playback systems. The 3D Series allows all three integrated decks to be played at once with independent audio and control information. To go with the newly acquired company, 3M showed a brand new **ScotchCart** broadcast tape cartridge with playback head shield and tension arm.

Other cart machines which drew

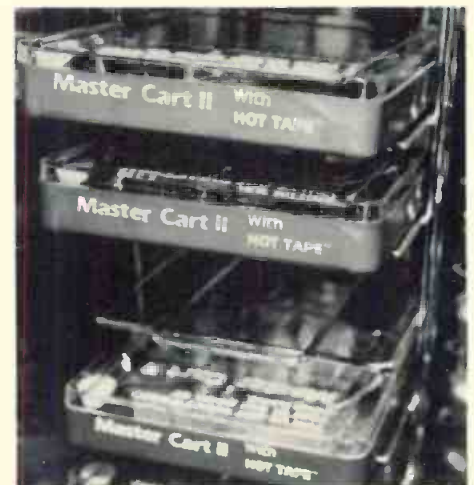

Master Cart II from Fidelipac.



of two optional stereo limiters, which plug in and automatically connect to two or four group outputs. **Ampro** demonstrated the **Microtouch** console with five or eight mixers and dual mono and stereo outputs. **UREI** showed the **Mod One** AM and FM broadcast console with a wide selection of input modules and plug-in amplifier cards.

Arrakis introduced to the NAB its line of broadcast consoles with up to eight channels, balanced inputs, and rotary or slide faders. **Audio-Technica** introduced its new **ATC units** (selling for under \$2000) with eight and 12 inputs with program graphic equalization. **Quantum Audio Labs** showed its variable input mainframes with stereo outs and program/audition masters. **Electro-Voice** displayed its **Tapco** mixer with eight balanced inputs and two outs.

The **Pluto 3/1** mini mixer for ENG with three inputs is from **Tore Seem**. **Ramko's DC-12 Series** of consoles features remote control and a four year warranty. **Audioforce** introduced a 16 input mixer in a case with handle, featuring slide faders and EQ selling for \$4490. From **Logitek**, the **Audiorack** is configured in a 19-inch rack mount style and features optional power supplies and six channel capability.

For more information: Harrison Systems TV-3, 275; Quad Eight 248 Component Series, 276; Soundcraft Series 2400, 277; Rupert Neve 51 Series, 278; ADM Model 2400, 279; Ward-Beck R 1000, 280; LPB Benchmark Series, 281; Broadcast Audio System 20, 282; Harris Micro Mac, 283; Sphere Eclipse Series, 284; Sphere Travis faders, 285; Penny & Giles 3000 Series, 286; McCurdy SS8650, 287; MCI studio package, 288; MCI JH-500 Series, 289; Pacific Recorders BMX consoles, 290; Broadcast Electronics 10S350, 291; Auditronics Series 200, 292; Clyde Electronics customized production consoles, 293; Panasonic WR-8000 Series, 294; Interface console, 295; Howe Audio 7500, 296; Trident Trimix consoles, 297; Eela Audio S 41, 298; MCI JH-800, 299;



Smaller consoles from ADM (left) and Quad Eight (right).

tal level changes. **MCI's new JH-800** AM, FM, and TV console contains its own power supply, four VCA controlled groups, and dual stereo mix capability. It also has a meter panel which folds down into the mixer body and sells for \$14,000. **Satt Electronics'** **SAM Series** of portable mixers comes in two configurations. The **SAM 82** is an eight-input model and the **SAM 42**, a four-input featuring slide faders and equalization.

Along with its 900 Series consoles, **Studer** showed its **69 Series** of remote consoles with foldaway metering, internal nicad batteries, and long throw faders. Another line of portable mixers new to the NAB was from **Audio Developments** in a 6 x 2 configuration. The **AD045 Pico Plus** has transformer balanced inputs, equalization, and three-position switch selectable metering for VU, PPM, or N10. **Micro Trak's Sport III** and **IV** consoles are intended for remote use, with the **Sport IV** having four mixable mics and select switch for carts or cassettes.

Tweed Audio unveiled the new, totally customized **BC 102/104** portable consoles with 10 inputs, four outputs, and equalization. There is also space provided in the console for the addition



Panasonic's Ramsa WR Series console.



EIMAC cavities cover 54 to 970 MHz at power levels to 30 kW —our design or yours

Varian EIMAC has complete cavity design and production capability. We make sure that tube and cavity are compatible. If it isn't an off-the-shelf-item, we have the designers and engineers for any specific job.

EIMAC has expertise in all disciplines including pulse, CW, FM, and TV. We match tube, power,

bandwidth and operating mode to achieve optimum performance.

More information on EIMAC cavities and tubes is available in our Cavity Capability brochure from Varian EIMAC. Or for prompt consideration of your special design requirements, contact Product Manager, Var-

ian EIMAC, or the nearest Varian Electron Device Group sales office. Call or write today.

Electron Device Group
Varian EIMAC
301 Industrial Way
San Carlos, California 94070
415-592-1221

Varian A.G.
Steinhauserstrasse
CH-6300 Zug, Switzerland
Tel: (042) 23 25 75
Telex: 78 841

EIMAC Cavity	Matching EIMAC Tube	Tuning Range (MHz)	Power Output
CV-2200	4CX20,000A	86-108	30 kW
CV-2220	3CX1500A7	86-108	1.5 kW
CV-2225	4CX3500A	86-108	5 kW
CV-2240	3CX10,000U7	54-88	10 kW†
CV-2250	3CX10,000U7	170-227	10 kW†
CV-2400	8874	420-450	300/1250 W*
CV-2800	3CX400U7	850-970	225 W
CV-2810	3CX400U7	910-970	190 W

* pulsed power

† peak sync, or 2.5 kW combined in translator service



varian



NAB PHASEMASTER UPDATE!
"When we came to the show we were going to replace all of our cart machines with reel-to-reel. After listening to the PhaseMaster we've changed our minds."
NAB Broadcaster

THE \$250,000 CART MACHINE.

by Ray M. Kohfeld, President, Ramko Research

PhaseMaster, The industry's most advanced broadcast reproduction system.

From the beginning of the PhaseMaster cart machine project more than two years ago, we were convinced there was an electronic solution to the problem of stereo phase stability. Consistent stereo reproduction and machine-to-machine compatability could be solved. We believed that for many crucial system parameters, performance could be achieved in a cart system that would meet or exceed the best reel-to-reel machines.

What we didn't realize however, is that the development of the "ultimate" cart machine would cost over a quarter of a million dollars and take thousands of man-hours to accomplish. We finally achieved what we were after—no, what you were after—but not without some very trying times.

Early on, the goals were clear.

By employing leading-edge technology throughout each area of the tape system, we felt that the PhaseMaster could out-perform everything in the audio chain. Right on through the transmitter. The signal-to-noise, distortion and wow and flutter performance criteria had to rival reel-to-reel specs while retaining all the conveniences and benefits of the standard plastic tape cart. The major problems of tape skew and guidance had to be overcome in order to deliver a system which would, once and for all, take care of phase problems. This problem was judged by us to be absolutely critical for proper and consistent stereo reproduction. FM now, and AM just around the corner.

The final goal we set for ourselves was to design a cart system that offered automatic machine-to-machine compatability—an important benefit that to our knowledge no other reel-to-reel, cartridge machine or add-on processing

system offers. We believe that it is a significant factor for the broadcaster to be able to pickup anyone's cart at random, record it on any PhaseMaster and then play it back on any PhaseMaster; the program material being precisely locked in-phase. Whatever the phasing of the original source, the signals will be automatically and faithfully reproduced. Ultimately, tape skew, chatter or even head misalignments would no longer be a problem.

Side-to-side stereo shift; holes in the mono mix or worse yet, reception; audio modulation due to tape chatter from the cart: major problems that we've lived with for years. You waste valuable time trying to get around it, cart manufacturers would like you to believe that it's solved in their carts, programming and management don't want to hear about it, and your audiences reach for the dial when your station doesn't sound good because of it.

To have introduced another cart ma-

chine that didn't solve all these persistent problems would have been negligent. To say the least, another mouse-trap. As we've stated, the goals were clear from the onset, but not the solution(s).

Our attempts at phase correction: shortcuts aren't our way of doing things.

When we first looked at the problem, there existed only one other means of phase correction. This is an electro-mechanical approach which adjusts head alignment for each cart prior to the initial recording. Although this is certainly an improvement over what had existed (nothing), we felt it had many shortcomings. It can't correct phasing in real-time, the compatibility factor is not high enough, it's overly complex—subject to breakdowns, and it adds valuable, additional time to a producer's already busy schedule of production.

What about stereo matrix?

Another approach which initially offered some technical promise at the outset was stereo matrixing. We went down this road early and discovered that a matrix system not only added unwanted electronic noise (something we were taking great pains to get rid-of) but it did very little to accomplish our goal of machine-to-machine compatibility. These fundamental drawbacks are inherent in this design approach and we eventually discarded it after many attempts to make it do things it just couldn't do.

Cross-correlation and signal injection: not the answers either.

After discarding the stereo matrix approach, we researched the viability of mixing timing signals onto the Left and Right audio tracks. This was closer to what we had in mind but detracted from the end result in that the audio had to be reprocessed which naturally degraded the high quality audio we were aiming for.

The third technique investigated was a cross correlation scheme that is essentially a form of probability theory with user adjustments. This also was eventually dismissed because of its inability to second-guess many complex waveforms and the necessity to readjust for various types of program material.

Although all of these approaches have some merit and have since shown up in the marketplace, the individual shortcomings were too much of a compromise of the promises to ourselves that we could do it better. Much better.

The answer! Perfect phase correction via the Q-track.

The elegantly simple and totally unique answer to the phase-stability problem came because of persistence and, at times, downright obstinance to not accept anything less than what we set out to achieve: picture perfect phase accuracy and stability—an ultimate, real-time correcting solution to the biggest problem the cart system serves up to every broadcaster.

The phasing (or more accurately, time base) correction system in the new PhaseMaster cart machines takes a sample of the upper (Left) audio channel, encodes it and then records it on the cue track without interference to any other information. Upon playback, the encoded signal is reconstructed and compared to its mate on the upper track so that we now have two identical signals to compare with each other. This has been the key. We are now able to compare apples to apples. Dissimilar information normally found in Left and Right audio is no longer a limiting factor. After these two identical signals are compared by a clever signature-determining circuit, a control signal is developed. Any time-base differences between these signals are applied via control signals to timing circuitry in both the Left and Right audio for correction. The result? Phase correction in real-time...measured in microseconds. The heads, the tape or both can be severely out-of-whack and the PhaseMaster's phase compensating electronics don't care. The audio can be complex, sinusoidal or recorded only on one track.

You can record your program material on any PhaseMaster Record/Play machine and rest assured that it will reproduce exactly like the original source no matter it be across the hall or across the world.

Control instrumentation technology helped us find the solution and we're now preparing for patent application.

Compatibility with your present system.

The new PhaseMaster also offers you compatibility with all your present, previously recorded carts. An easy transition can be made at your own pace without having to rerecord your station's entire library. To state it simply, PhaseMaster now gives you a professional R/P system without the drawbacks you've grown accustomed to.

Last, but not least, the best mechanical design you've ever seen.

The deck is a 5/8" casting for stability, with a stainless steel cover plate for

wear-resistance and EMI shielding. A crystal-controlled D.C. servo motor insures timing accuracy to within $\pm 0.05\%$ and, practically no heat generation. The speeds are field selectable: 3 $\frac{3}{4}$, 7 $\frac{1}{2}$, and 15 ips.

Your carts are securely held in position by the edges to prevent distortion, using spring-loaded rollers. Insertion and withdrawal is smooth and positive-feeling. The machined head stack is rock stable, and we've included internal illumination for periodic inspections and maintenance. There are no microswitches to break or jam—and never any start-up wow because the motor is started by an optical sensor as you begin to insert the cart. To keep damaging heat away from the tape, the capstan is ceramic. And bearings have a longer life because the motor doesn't need to run continuously due to the cart sensing design and the ability of the motor to reach full speed by the time the cart is fully inserted. The pinch roller is engaged by an adjustable air-damped solenoid with a teflon coated plunger for friction-free, quiet operation.

On the PhaseMaster R/P machine you get front panel switch selectable inputs; integral diagnostics for faster, easier maintenance; three cue tones are standard. An automatic 4 $\frac{1}{2}$ digit timer is standard. Left/Right audio plus phase analysis solid-state meters, motor "out-of-speed" and "already played" indicators are standard, too.

With the kind of performance we didn't compromise.

We've set new standards for wow and flutter: .04-.07%. The amplifier's signal-to-noise is -65dB utilizing dynamic noise reduction without companding or expansion. Frequency Response is ± 1.0 dB. And, of course, there's balanced I/O's and a +25dBm output capability.

It's been worth the wait.

We call it the \$250,000.00 cart machine. That's what we invested on our bottom line to engineer a system that you can have for less than \$1,400.00.*

Call us collect at (916) 635-3600 or contact your Ramko sales rep for more information and a schedule of when you can have a free, two week trial of PhaseMaster—the industry's most advanced broadcast reproduction system.

*PhaseMaster playback machine. Prices subject to change without notice.

Engineered For Your Bottom Line.

RAMKO

Ramko Research, 11355-A Folsom Blvd., Rancho Cordova, California 95670 (916) 635-3600

Circle 122 on Reader Service Card

much attention came from IGM, with its Go-Carts and Insta-Carts in various configurations, including the automated set-up. UMC showed a triple deck, 3D model cart with three decks in one box with improved motor shaft, low wow and flutter, and interchangeable chassis. Pacific Recorders devised a completely configured studio setup with its Tomcat cart machines and audio consoles. Improved tape transport systems marked the offerings from the Audi-Cord Corp.

The Master Cart II rounded out the full line of tape cartridges from Fidelipac, which feature low friction tape path and a new front corner post for precise alignment. Various Audiopak cart sizes and specifications were on hand from Capitol Magnetics.

In reel-to-reel recorders, combining both television audio interests and portable requirements, Nagra Magnetics' new T-Audio recorder with detachable remote control unit featured a twin capstan open loop system, four speed playback, and inter-head tape tension sensor. It has built-in SMPTE time code synchronization.

In rack mountable and portable combined units, the latest innovation came from Studer with its A810 reel-to-reel recorder. The new deck features digital programming of both the transport and audio systems. It can be synchronized with time code without sacrificing a track.

On center stage at Ampex were the ATR-800 and the ATR-124. The 800 is a broadcast tape machine with one,



Otari MTR-90 24-track ATR, synchronizer.

two, or four tracks, and is the newest in the Ampex line. The 124 is a multitrack recording deck coming in 8, 16, or 24 track versions.

The new deck from MCI was the JH-110B in four and eight track versions, a high profile cabinet, a 19-inch rack mount, or mounted into a console. The JH-45 SMPTE synchronizer, auto locator can be patched into MCI's 600 series board.

Otari's MTR 90 was synched to a video system with a Convergence TCR-100 time code reader, Otari's CB-113 remote control, and the CB-115 auto locator. The MX 5050 eight track and the Mark II-2 ¼-inch

two channel recorder were also on display.

Tape loaders and duplicators made an impact at the show with Garner showing improvements in its transports for increased speed duplicators. Audioco demonstrated its audio line of tape loaders with improved spools. Telex featured its Series 300 duplicating system and cassette copiers. Other units shown by Telex were the 3000 Series of reel-to-reel decks with Mu-metal head shields and the MC-II line of broadcast cart machines.

Teac Tascam's central unit was the 85-16B 16 track recorder/reproducer which has optional auto cue and remote control unit. Accurate Sound's AS-4000 cassette logger is a rack mount system for low speed logging.

Maxell, though a manufacturer of a complete line of audio tape, chose to bring only its video products. TDK displayed its full line of industrial and professional audio tape. Both 3M and Ampex also brought their complete assortment of audio recording tape for the broadcast industry.

In tape deck replacement heads, Saki Magnetics provided a full complement of metal and ferrite heads for duplicators, loggers, and reel-to-reel machines. Along with its bulk tape erasers, alignment tapes, and splicing blocks, Nortronics unveiled a new head degausser for heavy duty, two-inch tape heads. Also announced were two new three-channel heads for ¼-inch tape to fit the full ITC line of cart machines and IGM's InstaCart.



Ramko PhaseMaster cart deck.

For more information: Ramko Research PhaseMaster, 304; International Tapetronics Corp. 99B, 305; 3M ScotchCart cartridge, 306; Fidelipac Master Cart II, 307; Nagra Magnetics T-Audio, 308; Studer A810, 309; Ampex ATR-800, 310; Ampex ATR-124, 311; MCI JH-110B, 312; Telex Series 300, 313; Nortronics degausser, 314.

Harris' New SX Series of All-Solid-State AM Transmitters

Now a high technology blend of broadcast and computer science has created the SX-1 (1000 watts), SX-2.5 (2500 watts), and SX-5 (5000 watts)—Harris' new family of all-solid-state high performance, high reliability AM transmitters!

Harris' solid-state experience brings you energy-saving efficiency. A typical SX-5 equipped station can expect an annual power bill reduction of 15 to 36%.

Exciting new technology is employed throughout the line, including Polyphase Pulse Duration Modulation* for exceptional audio performance. Plus microprocessor control and status monitoring, sophisticated diagnostic techniques, and a unique cooling system that protects components from dirt build-up. All SX transmitters are designed for AM Stereo operation.

Find out what this new generation of Harris transmitters can do for you. Contact **Harris Corporation, Broadcast Division, P.O. Box 4290, Quincy, Illinois 62305-4290. 217-222-8200.**

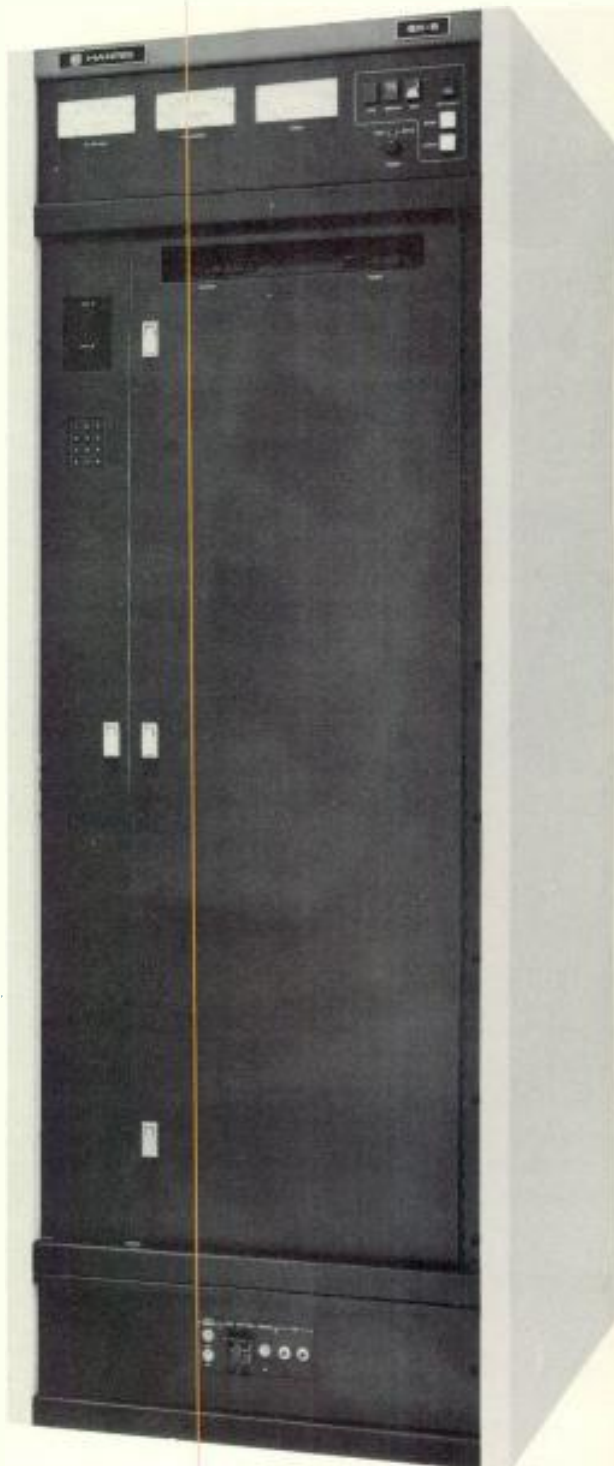

*Polyphase PDM — Patented.



HARRIS

Circle 123 on Reader Service Card

www.americanradiohistory.com

Listen through it. Not to it.



INTRODUCING OPTIMOD-AM MODEL 9100A

Orban's new second generation OPTIMOD-AM introduces a remarkable new sound to the AM band: a dramatically open, effortless, defined, *FM-like* sound combined with extremely competitive loudness; RMS levels as much as 3dB higher than those produced by our previous processor. Yet you listen to the music, not the processor!

The new 9100A combines the best ideas from our previous 9000A with some of those introduced in the popular OPTIMOD-FM 8100A. Performance is further extended with new developments in distortion-cancelled multiband clipping and receiver equalization. The bottom-line is a processor that develops its FM-like sound on *real world* auto, table, and portable radios. And a processor that solves broadcasters' real-world problems, including sloppy operator gain-riding, inconsistent source material, and transmitters that tilt, overshoot and ring.

The new 9100A is available in single-chassis stereo or stereo-convertible mono versions. Sum-and-difference stereo processing means highest mono loudness from any of the AM stereo systems. Integrated construction and high-precision parts assure accurate dynamic tracking of the sum-and-difference channels, guaranteeing separation of at least 20dB (50-10,000Hz)—with better than 30dB typical. Compare before you buy!

There's much more to the 9100A's exciting technical story than we can possibly tell here. See your Orban broadcast products dealer, or contact us directly for further details:

Orban Associates Inc., 645 Bryant St., San Francisco, CA 94107. Toll Free (800) 227-4498, In California (415) 957-1067. Telex: 17-1480, Cable: ORBANAUDIO

orban

ORBAN PROCESSING KEEPS YOU COMPETITIVE

Circle 124 on Reader Service Card

Audio processors

Each year recently audio processors have taken on more functions in radio broadcasting and production, and capabilities for established functions have been enlarged, refined, and extended. Equipment shown at the Dallas convention registered the largest advances along these lines for any year so far.

The central processing role, of increasing modulation density for a "louder" signal on the air, with control of peaks to avoid overmodulation, was served in a number of new and refined systems. **Audio and Design Recording** had the new **F601 Super-Dynamic Limiter**, with 100-db dynamic range, claimed to handle PCM digital as well as analog signals. **Audio + Design** also emphasized the **Transdynamic** three-band compressor/limiter system, available with improved characteristics.

Designed especially for SCA channels was a new **gain-control and limiter system** from **CRL Systems**. It consists of two units, the **APP-400** audio preparation processor, to correct tonal balance and level in the source material; and the **SCA-300** modulation controller and final audio peak limiter. A low-distortion SCA generator is included in the system.

A new edition of the **Dorrough** Discriminate Audio Processor, the **Model DAP-610**, introduced new refinement into this three-band system, in wide use for several years. The new model uses a frequency-discriminate digital control signal for gain adjustment. Action is extremely fast, on the leading edge of the waveform.



New audio processing from CRL.

Inovonics showed a new five-band compressor/limiter system, the **Marcom 85**, which is programmable for a wide variety of applications in FM stereo, AM stereo, and television. The action can be programmed for a particular on-air format, and the system memory will hold the pattern for instant recall. **Inovonics** also showed the **MAPS II**, a processing system designed primarily for AM broadcasters.

Modulation-control systems using optical attenuation for smooth action were brought by **Elcom-Bauer**. **AGC Level Guard** is an all-band system and the **AP-5 Insta-Peak** is a two-band system. A third unit, **MP-12**, continuously controls positive to negative peak ratios.

A system widely used in Europe, the **EMT Model 266** transient limiter, was shown by **Gotham Audio**. It delays the program material about 0.3 ms and ex-



Calrac mic processor (discussed under "Microphones").

SAVE MONEY

DIGITAL AUDIO DELAY
BLEEMATE™ 675/II

\$1625

Now you can end the bother and uncertainty of tape audio delays and save thousands of bucks.

You can buy this new solid-state simplicity for just \$1625—hundreds less than many tape delays cost.



Comex's new Bleepmate-675/II a simple yet sophisticated, fixed, 6-second solid-state delay, has no moving parts (so technical and on-air talent aren't bothered by endless tape/head upkeep). And the 675/II has a broad +/− 1dB, 20Hz to 7.5KHz response. Its low price makes systems redundancy practical too.

Contact us today:
Comex Systems
2 Columbia Drive
Amherst, N.H. 03031
(603) 889-8564

Or order from your favorite distributor

COMEX SYSTEMS brings you the best price/performance available.

COMEX SYSTEMS

Circle 125 on Reader Service Card

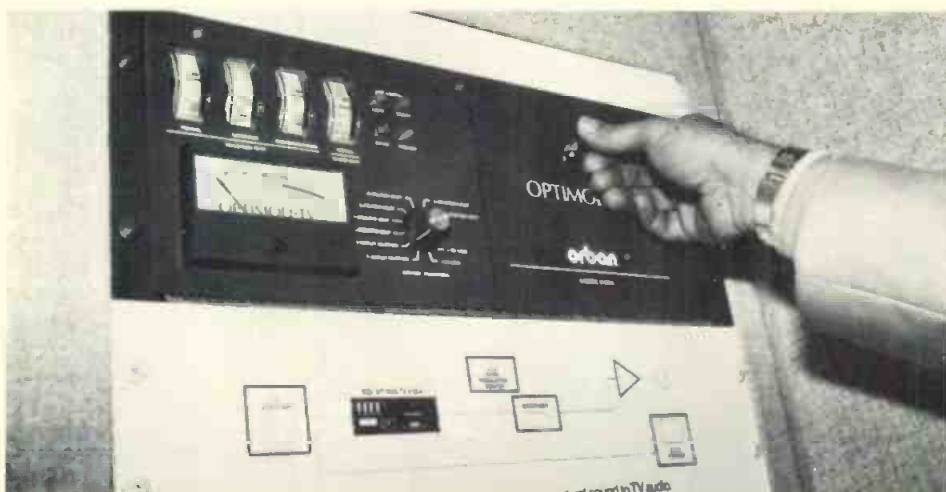

Orban's new Optimod processor for TV.

tracts control information before the program reaches the controller. This minimizes the distortion often caused by hard limiting.

Another fresh approach to peak limiting appeared in the new **Composite Limiter** introduced by **Modulation Sciences** and shown by David Green Consultants. This unit does not include the usual gain-control circuitry and is free of noise effects. It can be used with or without a compressor/limiter system ahead of it, and claims handling of up to six dB more RMS modulation without

audible distortion. It is completely transparent to the 19 kHz pilot signal and thus is acceptable to the FCC.

Orban's AM-Optimod appeared in a new version, the **Model 9100A**, for which a higher modulation density, with a cleaner signal, is claimed. Orban also introduced the **Optimod-TV**, an FM multiband compressor/limiter modeled on the FM Optimod and designed specifically for improving the modulation capabilities of the television audio signal.

United Recording Electronics In-

dustries had the series of limiters and compressor/limiters marketed for several years. **Harris Corporation** had a working demonstration of the **MSP-90**, the highly flexible compressor/limiter system, introduced earlier, adjustable for a wide variety of processing needs, in both AM and FM.

Thomson-CSF showed the line of audio units marketed for several years, including the pioneering audio processors, the **Audimax** and **Volumax**.

Datatronix has taken over many of the modular units formerly made by **Automated Processes, Inc.**, including the compressor/limiters, equalizers and related systems.

Kahn Communications had the processing systems introduced at earlier shows. "**Symmetra-Peak**" equalizes peaks in program material to allow higher modulation; "**Non-Symmetry Mod**" allows high maximum positive peaks in AM material. "**Sound Off**" cuts noise on a channel when no signal is present.

For more information: Audio and Design Recording F601, 315; CRL Systems gain-control and limiter system, 316; Dorough Model DAP-610, 317; Inovonics Marcom 85, 318; Elcom-Bauer Level Guard, 319; Gotham Audio EMT Model 266, 320; Modulation Sciences Composite Limiter, 321; Orban Model 9100A, 322; Orban Optimod-TV, 323.

STATION OWNERS BUY IT!



Station owners buy Auditroneics' 200 Series on-air console because they

know over 99% of all Auditroneics broadcast consoles ever built are still in active, every-day service. Owners buy Auditroneics because they know they can hire better on-air people if they give them state-of-the-art equipment to work with. They buy Auditroneics consoles because we can ideally equip everything from a 250-watt daytimer to a

major network facility, including on-air, production and remote truck models. They buy Auditroneics because they know the 200 Series console will outlast its competitors and be worth more at resale. If you'd like to know more about why station owners buy Auditroneics, circle reader service number or call

 **auditroneics, inc.**
3750 Old Getwell Road, Memphis, TN 38118
(901) 362-1350



Circle 126 on Reader Service Card

Dolby

Plug Better Sound Into Your Picture

The Dolby® Cat. No. 221 or 226 module allows you to plug the benefits of a Dolby A-type noise reduction directly into your Sony® BVH-1000/1100 or Ampex® VPR-2 1" VTR*. Operation is fully automatic. And at long last the audio performance of your VTR will rival that of professional audio tape recorders.

Dolby A-type noise reduction has been accepted for years throughout the world for high-quality tape recording and other audio transmission and storage media. It provides 10 dB of noise reduction from 30 Hz upwards, increasing to 15 dB at 9 kHz and above, without the audible side effects (such as noise modulation and overshoot distortion) associated

with more conventional techniques. Dolby noise reduction can also lead to lower distortion, as it permits more conservative recording levels to reduce the risk of tape saturation.

Today wide audio bandwidth and low noise are becoming commonplace in many parts of the television origination/transmission chain. Contact us to find out how Dolby noise reduction can prevent the VTR audio track from being one of the weak links.

*Outboard Dolby noise reduction units are available for use with virtually any other video or audio recorder.



Dolby®

Dolby Laboratories Inc.

731 Sansome St.
San Francisco,
California 94111
415-392-0300
TELEX 34409

346 Clapham Road
London SW9 9AP
England
01-720-1111
TELEX 919109

Special effects

Another group of new processors, the digital special effects and artificial reverb systems, also carried the technology forward. **Eventide Clockworks** introduced the **SP-2016**, which uses plug-in program modules to establish an extremely broad range of special effects and reverb patterns. The maker already has a large set of program modules for the system and is developing more. The user can develop his own with the aid of the system.

Lexicon's Model 97 "Super Prime Time" also extended the reach of special effects technology to new limits,



The Eventide SP-2016 programmable processor.

with a large memory for storing the effects setups, for instant recall. In digital reverb. **Lexicon** had the new **Model 224X** with a number of built-in reverb patterns, plus adjustable reverb times of 0.6 to 70 seconds and 36 registers to store settings.

Ursa Major showed the firm's latest digital reverb system, the "8x32", another giving great flexibility in setting reverb patterns. with storage of 64 patterns. Ursa Major's special effects system, the "Space Station", popular for several years in broadcasting, was also demonstrated.



Lexicon's 224X digital reverb system.

A French firm, **Publison Audio Professional**, demonstrated the "French Infernal Machine", a digital special effects system with dual delay up to 1200 ms at 5 kHz, 300 ms at 20 kHz. Optional memory can increase delay capability to 5000 ms. The system provides a rich repertoire of effects, including pitch shifting, arpeggio, reversed sound, and many others.



The Ursa Major 8x32 digital reverb.

Quad Eight had the System Five digital reverb, available earlier, which has hundreds of selectable reverb patterns.

For more information: Eventide Clockworks SP-2016, 324; Lexicon "Super Prime Time", 325; Lexicon Model 224-X, 326; Ursa Major "8 x 32", 327; Publison Audio Professional "French Infernal Machine", 328.

Noise reduction

Noise reduction was another technique actively demonstrated in new and old systems. **MicMix** introduced an entirely new system, **Dynafex**, which does not use encoding/decoding to reduce noise levels. The maker says that any program source can be treated for signal-noise gains up to 30 dB. The Dynafex uses a modern version of the "sliding filter" system with the pass band automatically adjusted to minimize noise.

dbx showed new compact mountings for the firm's broad-band noise reduction systems.

Dolby continued to move strongly into television audio systems, with a two-channel Type A noise-reduction module that fits directly into Ampex VPR-2 Type C VTRs. The unit, like the

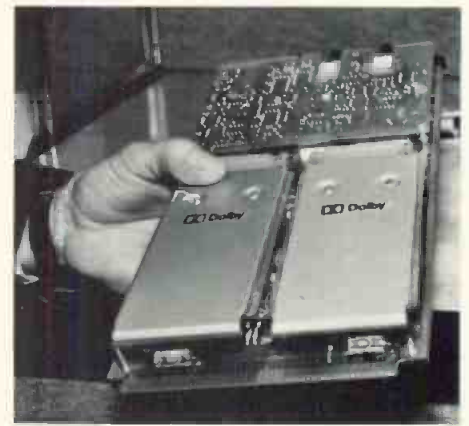

Dolby noise reduction module for Ampex Type C VTRs.

module developed for Sony decks, replaces the VTR's audio board to improve overall signal performance up to 24 channels. Dolby also introduced a new compact Type A system for multi-track tape recorders.

Gotham Audio had the **Telefunken C-4**, the four-band noise-reduction system used in Europe. **Straight Wire Audio** had detailed information on "High-Com", the Telefunken one-band system being made in the US by SWA under license and marketed here by that firm. The High-Com system claims up to 20 dB of noise reduction, with very low distortion and operational noises.

Deltamod Corp. brought a new method of maximizing broadcast cart performance in the **CNR-6** automatic noise reduction and matrixing system. The system incorporates the new Dolby "C" noise reduction system for up to six stereo channels in one unit, together with automatic matrixing of left and



MicMix Dynafex noise reduction demo.

Storeel is dedicated to conserving energy. Yours.



Energy conservation is much in the news these days. Like the weather, many talk about it but few do anything about it. We haven't figured how to change the weather, but we do have several systems specifically engineered for broadcasters that both conserve energy and add efficiency. The very latest (shown installed) is called **STOR-MAX™**

Save energy (yours) by converting your overcrowded film and VTR libraries to the new "Instant Access" high-density systems engineered and distributed only by Storeel. **Modular Rapid Transit Storage™** maximizes units stored per square foot of floor space, minimizes retrieval time, optimizes energy efficiency.

Our many years of design and engineering pay off in solutions to your storage problems.

Call or write "The Railriders" at Storeel today for free estimate. No obligation, of course.



Illustrated catalog of Storeel's "confusion eliminators" available upon request. Write on your letterhead or telephone for your free copy.

STORREEL CORP.

**The
Space-Saving
Engineers**

2050-C Carroll Avenue • Atlanta, Georgia 30341 • Telephone (404) 458-3280



Circle 128 on Reader Service Card

**... SO SAVE MONEY, STREAMLINE YOUR REMOTES AND IMPRESS THE SPONSOR
BY GETTING IT ALL TOGETHER WITH THE COMREX SLX.**

Circle 129 on Reader Service Card

right signals for phase error control,

channels, and applies needed correc-

ALL NEW, We took an industry work-
WITH —and made it even more versatile. We
OVER EASY gave it Over Easy® so you can choose
TOO. soft knee or hard
\$420.* knee compression
 at the touch of a button. We've also made
 it strappable for dual channel compression.
 Added dual LED meters, Infinity +™
 compression, and the provision for a
 Jensen output transformer. And, we've put it all into a
 new slim-line rack mount package with phone jack and
 barrier strip connectors. Voila! The new Model 160X.
 See your dbx Pro dealer, or write for information.

*Manufacturer's suggested retail price.



Model 160X Compressor/Limiter

dbx, Incorporated, Professional Products Division,
 71 Chapel St., Newton, Mass. 02195 U.S.A.
 Tel. (617) 964-3210, Telex: 92-2522. Distributed in
 Canada by BSR (Canada) Ltd., Rexdale, Ontario.



Circle 130 on Reader Service Card

The AUTOMATIC Audio Test System

That Measures. . .



MODEL AT-51
 AUDIO TEST SYSTEM

- Harmonic Distortion
- Intermodulation Distortion
- Volts
- dB
- Signal + Noise / Noise Ratio
- Wow and Flutter
- Stereo Phasing
- Differential Gain in Stereo Channels

Contact Us Now For Complete
 Details And Descriptive Literature.

POTOMAC INSTRUMENTS

932 PHILADELPHIA AVE.
 SILVER SPRING, MD. 20910
 (301) 589-2662

Circle 120 on Reader Service Card



MKE 40-3 directional lavalier from
 Sennheiser.

including the 44C and 44M Series. The new line has an integral antenna contained in the end cap. Telex has also come out with two new wireless mics, WHM-300 and 400, designed primarily for entertainment applications.

Nady Systems announced the arrival of its Pro-2 Series. There are three styles of tunable wireless microphone and instrument transmitters. The HT-2 is a hand-held transmitter that attaches to any professional vocal mic. The one-watt wireless communicator system was demonstrated with the VHF mic system and the VHF 700 true diversity receiver for better reception in high noise areas.

Cetec Vega introduced the new Model 82 wireless mic with a Shure SM85 electret element. The Vega 81 was also on hand with audio gain control and a compression LED at the base. New from Swintek were the Radio microphones with Beyer M500 or Shure SM85 heads. Also new was the Swintek four-channel touring wireless mic console, complete and shipped in black formica rack housing and selling for \$13,950.

The number and variety of tiny microphones continue to grow, such as Shure's lavalier and small instrument mics in the 570 Series for broadcast which come with or without an on-off switch.

Sennheiser displayed its new MKE 40-3 directional lavalier, an electret mic having a cardioid pattern with a fre-



HME's wireless mic system.

Better listening through better design—Series 99B

...Crisp, Clean, Brilliant Sound

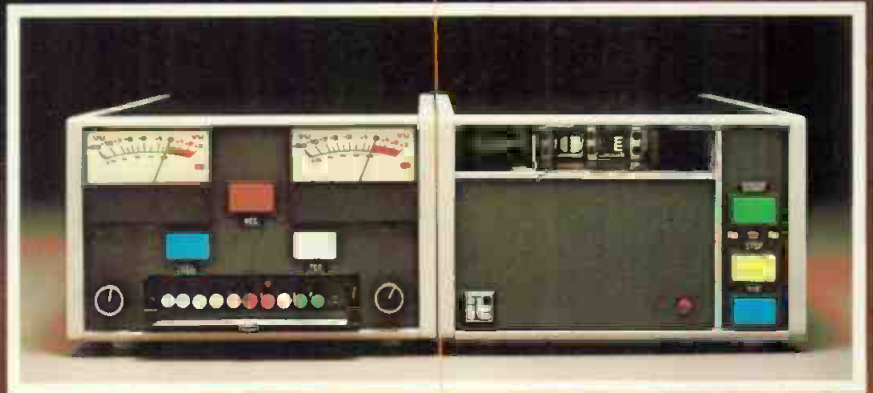

Superior features!

"ELSA" (Patent 4,142,221) the only Cartridge Preparation System that automatically erases the cartridge, eliminates azimuth error and locates the splice. "ELSA" combines with:

- Crystal-referenced DC Brushless Servo Motor
- Standard High-Speed Cue
- Micro-adjust, center pivot head module
- Exclusive ITC open-face head design (Patent 4,193,103)
- Exceptional Frequency Response
- Improved headroom, transient response and square wave performance
- Distortion-free cartridge positioning system
- Multi-turn Calibration Controls
- Multi-function Test-Tone Generator
- Dramatically reduced heat allows for sealed case
- Microprocessor controlled

Series 99B—a combination of performance features that meets even the highest standards.



International Tapetronics Corporation

2425 South Main Street, P.O. Box 241, Bloomington, Illinois 61701

Call Toll-Free 800-447-0414 to learn more about Series 99B and to receive our new, complete brochure.

Call Collect from Alaska, Hawaii or Illinois (309) 828-1381.

Circle 131 on Reader Service Card

Collins MVR: Because the show must go on... economically.



The Collins MVR series is a family of microwave radio equipment packaged in a stackable, simplex, single-channel arrangement for operation in each of the video relay frequency bands — from 2 to 13 GHz.

Through years of providing reliable performance at highly competitive prices, these radios have acquired a reputation as dependable workhorses in a wide range of broadcast, common carrier, government, CATV and corporate applications.

The compact MVR solid-state radio is designed to comply with EIA-RS-250 B Short Haul Requirements, and its modularity permits a wide variety of station configurations. Other features include simplified installation and maintenance, plus AC or DC operation.

To make sure your television picture goes to the tubes instead of down the tubes, rely on the MVR family and the depth of Collins experience behind it. For full details, contact: Collins Transmission Systems Division, Rockwell International, Dallas, Texas 75207. Phone: (214) 996-5340.



Rockwell International

...where science gets down to business

Atlanta, Ga. (404) 979-0888 • Denver, Colo. (303) 978-9600 • Independence, Mo. (816) 737-3033 • Indianapolis, Ind. (317) 547-8500 • Minneapolis, Minn. (612) 835-4989
Redwood City, Calif. (415) 365-3364 • Rock Hill, S.C. (803) 366-7428 • Killingworth, Conn. (203) 663-2571 • Tallahassee, Fla. (904) 877-2580 • Arlington, Va. (703) 685-2661

Rockwell has the latest words in communications: Collins Systems.

Brussels 242-4048 • Cairo 894531 • Frankfurt (0) 6106-4093 • Hong Kong 5-274-321 • Kuala Lumpur 27283 • London 01-759-9911 • Manila 818-6689 • Mexico City (905) 533-1846
Melbourne (Lilydale) (03) 726-0766 • Paris (Rungis Cedex) 687-31-02 • Rio de Janeiro 286-8296 • Riyadh 69060 • Rome (0) 6-862-415 • Seoul 74-9276
Tokyo 478-1278 or 478-1279 • Toronto (416) 757-1101 • Jeddah 54600

Circle 132 on Reader Service Card



Demonstration of Crown PZM mics.

quency response of 40 Hz to 20 kHz. Beyer devoted much of its effort to demonstrating the MCE 5 lavalier which is only 7mm in diameter and 23mm long.

Still one of the unique microphones to be applied in a variety of situations is the Crown PZM pressure zone mic, whose new twist includes two clip-on models. Shure also had surface mount units.

AKG brought its full line including the electret condenser studio mic, the 414 EB/P48 phantom-powered unit. Keith Monks Audio showed microphone booms and various accessories. Accurate Sound displayed its Starbird line of mic booms.

For more information: Electro-Voice Variable D, 348; Beyer Dynamic S 185 condenser, 349; Audio-Technica Series 800, 350; Audio-Technica uni-directional lavalier, 351; HM Electronics 44C Series, 352; HM Electronics 44M Series, 353; Telex WHM-300, 400, 354; Nady Systems Pro-2 Series, 355; Cetec Vega Model 82, 356; Swintek wireless mic, 357; Sennheiser MKE 40-3, 358.

Intercoms

Digital technology and computer control have found their way into studio intercommunications in a big way. Ward-Beck featured its Micro-Com microprocessor-controlled studio intercoms with numerous stations and configurations to fill almost any re-

quirement. One useful feature is the digital test field, which checks, by user-selected programming, the operation and function of any station in the system. The large rack system has separate pairs of cables for control and communications signals to eliminate common breakdown problems. The system can go as high as 200 x 200 stations.

On a different scale, RTS Systems' 801 master station is a control center with six full duplex intercom channels, four simplex circuits, and other functions. Clear-Com, with its System II, offers increased station capability, higher output levels, and will operate from 12 V dc. Clear-Com also has the option of two-wired balanced operation.

If the trend in studios is toward microprocessor technology, then the remote applications side of the intercom business is definitely leaning toward RF transmission. HM Electronics featured its new MB-150 base station for wireless applications. It is a wearable transceiver to be used with the MT-1000 transceiver and permits full duplex operations between two parties or a push-to-talk mode. Additional units may be added into the system.

Swintek demonstrated the Mark 200 full duplex wireless unit, and the Mark 9-2 dual antenna diversity system, which rejects low carrier signal for better reception. Telex showed its wireless system with new base station units that allow interface with hard-wired systems.

Cetec Vega also demonstrated a wireless system with full duplex or unlimited station push-to-talk operation. With its QX-2 base station, the entire "Q" system can be interfaced with wired systems. R-Columbia too, has introduced into its wireless system a base station interface for wired/wireless communications. It offers duplex operation and is compatible with any wired system now available.

In considering studio systems, the programmable matrix from Farrtronics offers cross connect between push-button and desired buses. The central matrix is one or more horizontally mounted rack frames which accept plug-in cards and vertical buses. ROH, with its Series 300 remote operator panel and interphone iso, offers source delegation capabilities.

BCA interphone system for hard-wired studio use, and carbon intercom headsets were displayed at the Television Equipment Associates booth.

For additional discussion of RF microphones, see the Microphones section.

For more information: Ward-Beck Micro-Com, 359; RTS Systems 801, 360; Clear-Com System II, 361; HM Electronics MB-150 362; Swintek Mark 200, 363; Swintek Mark 9-2, 364; Telex base station units, 365; Cetec Vega QX-2 base station, 366; R-Columbia base station interface, 367; Farrtronics matrix, 368; ROH Series 300, 369; BCA interphone system, 370.

Turntables

Dependability is always a concern when it comes to broadcast turntables. Some of the sturdy units at the show included the full line of products from Broadcast Electronics. The Clyde Electronics BTU 1 self-contained unit with equalizing amplifiers was also on hand.



Russco's Digi-Speed turntable.

Another industry standard comes from Technics, which demonstrated its R&B Series direct drive, quartz synthesizer tables incorporating digital read-out of exact motor drive speed. Russco had its full complement of broadcast turntables on hand, featuring the Mark VI Digi-Speed with quartz lock. Also on hand at Russco were the Q-Lock units and tone arms.

Standard equipment from Stanton was the Model 310 phono preamp/equalizer and the 981 Series of phono pickups. The BA-26 preamp and complete record cleaning accessories were also on display.

Other accessories at the show were the Audio-Technica professional tone arms and ATP Series of phono pickups. Also in accessories was Howe Audio's



Section of Ward-Beck's Micro-Com intercom.

stereo preamp conforming to NAB/RIAA disk equalization.

The featured disk reproducer was the **McCurdy SS3159C**, incorporating a Technics SP10 MK II turntable. **UREI** showed the **Model 1122** transcription preamplifier, a two-channel solid state unit for broadcast applications.

New from **Micro-Trak** was the **11P** turntable preamplifier with CX noise reduction, and the **6411** and **6410** stereo and mono preamps.

For more information: Russco Mark VI Digi-Speed, 371; Stanton 981 pickups, 372; McCurdy SS3159C, 373; UREI Model 1122, 374; Micro-Trak 11P, 375; Micro-Trak 6411, 376.

Amplifying equipment

There were no revolutionary developments in this area, but the overall solid quality of the products was impressive. Distribution amplifiers took center stage with **Audio Technologies, Inc.** featuring its complete line of DAs. The 2016 Series provides individual adjustment for each output, scan monitoring, and overload indicators. **ATI** also showed audio compressor and monitor amps.

Ramko Research's selection of DAs included the DA-6E, 6BR/E, and DA-16BR/E. The ARA-1612 router amplifier was also on hand.

Bosch Fernseh displayed its T Series of amplifiers and amp cards. The TAA-524 audio DA and the PS-525 power supply were mounted in a rack for demonstration.

Three types of distribution amps were highlighted by **McCurdy**, featuring the **AT 313** and **DA 506** universal amplifier and distribution system. **Pacific Recorders** brought its SDA-8 stereo DA which can be used for two monaural signals.

Other distribution amplifiers included **Micro-Trak's** 1 x 6, 2 x 6, and 2 x 3 DAs and **Broadcast Technology's** variety of audio components with amps and cards covering the audio spectrum.

Television Equipment Associates showed **Link Electronics distribution amplifiers**, and **Bryston Vermont** centered its display around the **Model 4B** power amplifier and the series of three power amps ranging from 50 to 200 watts per channel.

Other amplifiers included **Crown's** power-line with Multi-Mode, and **Straight Wire Audio's** UA-2 universal amps.

J.V. Electronics' entry in the distribution amplifier market includes its **DA-41**, and 46 distribution amplifier and the DA-43A DA frame. **Farr-**

tronics also showed a line of quality DAs while other amplifier products included the **BGW** model 75 and 150 power amps.

For more information: McCurdy AT313, 377; McCurdy DA 506, 378; Link Electronics distribution amplifiers, 379; Bryston Vermont Model 4B, 380; Straight Wire Audio UA-2, 381.

Monitors

The new products in audio monitors were not so much innovations as updates to already established lines. In this vein, **Electro-Voice** added another model to its Sentry Series of monitors, the **Sentry 500**, which has an adaptable wall mounting bracket. Frequency response is 40 to 18,000 Hz, with short term power handling capacity at 400 watts; long term is 100.



The Sentry 500 monitor from Electro-Voice.

JBL brought two new control monitors as replacements for older models, the **4411** replacing the 4313, and the new **4312** for the 4311. Both new monitors feature a high frequency radiator and new midrange driver.

Both **Tannoy** and **Technics**, with its R&B Series, brought established lines as did **UREI**. Along with its time-align studio monitors, **UREI** introduced a new **Model 6500** power amplifier to drive them. **Fostex** introduced new **6301** monitors designed specifically for location mixdown. They contain an integral 10 watt amplifier.

Full headphone lines were from **Stanton**, **Audio-Technica**, **Beyer**, **Telex**, and **Marcom**.

For more information: Electro-Voice Sentry 500, 382; JBL 4411, 383; UREI Model 6500, 384; Fostex 6301 385.

Remote control, STL, RPU

A growth in power as compared with that of earlier equipment was brought by a number of remote control and STL manufacturers at the show.

TFT Inc., for example, introduced a new interface circuit for the **Model 7900** remote control system, allowing a desk-top IBM computer to be added to the system. This gives the user the ability to program the operation of the system in Basic language. Floppy disk storage of programmed settings can be included for precise repeat of the programs.

TFT also brought two new STL systems. The **Model 8300** is intended to operate well in dense RF environments. The receiver has selectable IF bandwidth, narrow if there are adjacent signals that cause interference, broad for freer environments. The transmitter uses IF modulation, seeking a high S/N ratio. Key system specifications are given as 0.2 percent distortion at 1 kHz, S/N ratio with de-emphasis 75 dB, frequency response ± 0.1 dB, 50 Hz to 75 kHz.

TFT also introduced the **Model 8100**, for telemetry return, suited to remote control systems using FSK data modems. It eliminates any need to use the 67 kHz SCA channel, or a telco line, for transmitter telemetry.

Another new STL system claiming advanced characteristics came from **Moseley Associates**. The **Model PCL-606** is for mono service, or is usable in a dual configuration for stereo if a composite signal is not to be carried. The PCL-606/C is designed to handle the composite signal. The transmitter uses direct FM modulation with a synthesized reference oscillator, and a double balanced mixer for frequency conversion. The receiver has user adjustment of a PIN diode for maximizing signal to noise ratio. The demodulator uses digital pulse counting techniques for adjustment-free broadband performance.

Moseley also demonstrated the **MRC-2** microprocessor remote control system. It has multi-site capability and can handle up to 255 control lines, 255 status channels, and 255 analog telemetry return channels. Multiple CRT



New STL equipment from Moseley.

M/A-COM DCC proudly announces digital audio satellite receivers for the radio networks. Our MAESTRO™ (M/A-COM Earth Stations for Receive-Only) terminal is a complete 3-meter earth station system which receives high quality 15 KHz and 7.5 KHz digital audio signals. Each complete system includes: 3-meter antenna, low-noise amplifier, down-converter, digital program terminal, and installation cables and materials.

Uplink transmission equipment and complete earth stations can also be provided for private networking and common carrier applications.

Selected by AT&T/Bell Laboratories

MAESTRO™ is the result of combining the latest in earth station technology with digital program audio. The M/A-COM DCC design has been chosen for the AT&T audio network from among other approaches because of

superb technical performance and our broad-based experience in providing digital earth stations and audio equipment for international and domestic satellite needs, such as telephony, TV-sound, and broadcast program distribution.

Remote Uplink Capability

MAESTRO™ can accommodate multiple uplinks from remote locations within the same satellite transponder. This supports special broadcasting situations without requiring additional equipment for multiple transponder operation. The flexibility in this approach means graceful network expansion and implementation independent of other services.

Multiple Channel Selection

In larger networks, multiple T1 carriers can be received, and selection of carriers and audio circuits is done by simple thumbwheel selection or under external computer control.

Within a single transponder, up to twenty 15 KHz audio channels can be selected.

Affordable

MAESTRO™ terminals are available on lease terms, or can be purchased directly. Installation can be completed in less than one day using simple step-by-step instructions, and without the use of heavy equipment, extensive ground preparation, or technical know-how.

Don't delay! Let M/A-COM DCC show you how satellite program distribution can increase your AM or FM listening audience by offering the finest in audio quality.



Leading the Way in Satellite Communications Technology

PRESENTING THE MAESTRO™

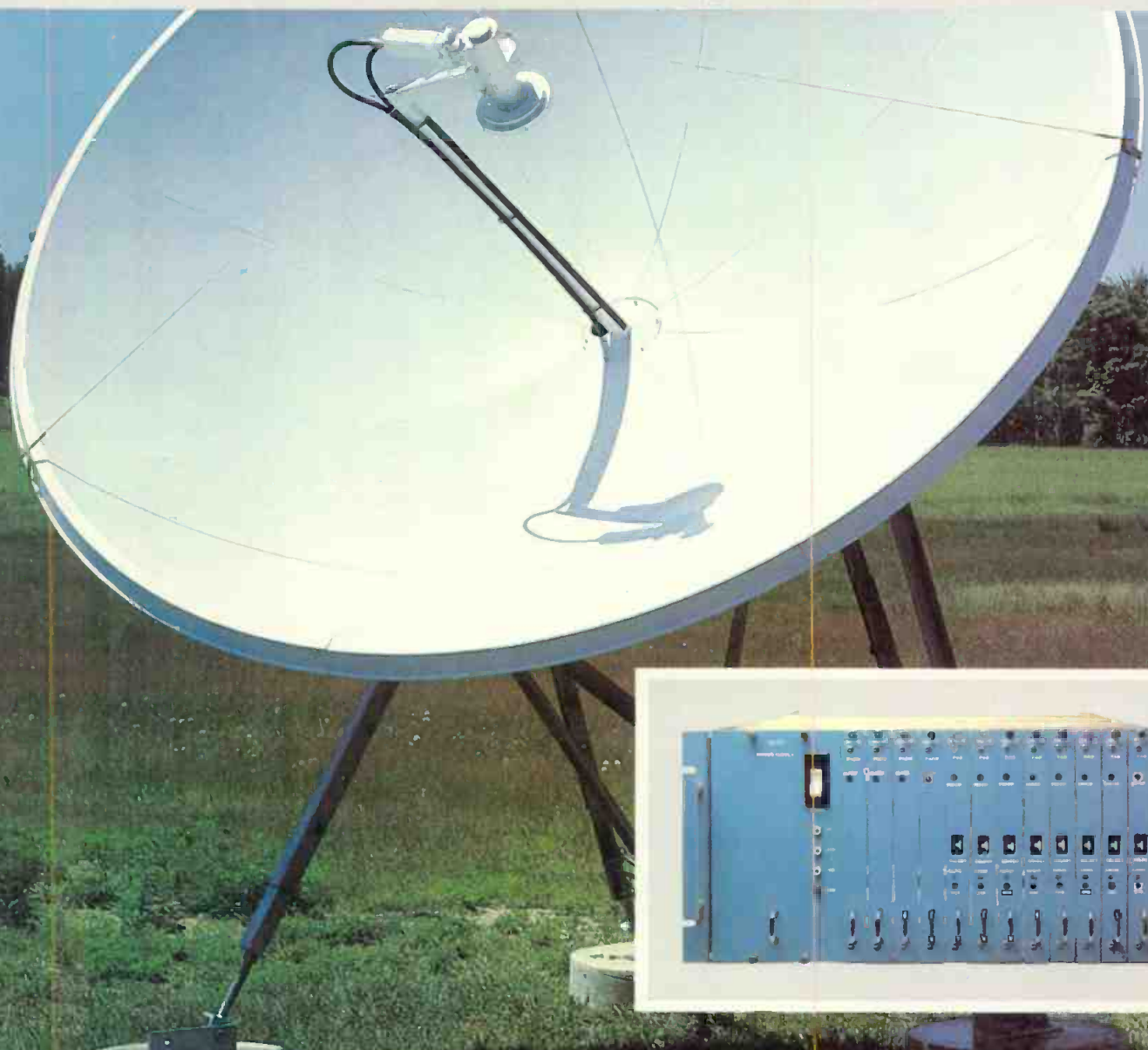

U.S.: M/A-COM DCC Inc., 11717 Exploration Lane, Germantown, MD 20874. Phone (301) 428-5532.
Canada: DTL, 1290 Airco Blvd., Mississauga, Ontario, L4W 1B2, Canada. Phone (416) 624-1810.
Europe: DCC LTD, Humphreys Rd., Dunstable Woodside Estates, Dunstable, Bedfordshire LU5 4SX, England.
Phone (0582) 666616.

Circle 133 on Reader Service Card

www.americanradiohistory.com



Demonstration of Marti remote pickup unit.

readouts, with real language display, are optional. An automatic control option adds command capability, to reduce operator intervention.

Potomac Instruments showed the new DAP-11, a standalone data acquisition and automatic logging system. It is available with CRT display or hard-copy printout. It also allows the operator to call by dial-up phone and get a verbal log readout at any time. Another new unit from Potomac Instruments was the FIM-72, a field strength meter for UHF signals, usable for FM, TV, or remote control and pickup systems. Another unit from Potomac was the SMR-11, an AM broadcast monitor receiver. It has ceramic IF filters with selectable bandwidth, thumbwheel setting for precise tuning, THD stated at 0.2 percent, S/N ratio 70 dB, and alarm circuits for carrier and modulation loss. An AM stereo demodulator and parallel audio circuit can be added on a plug-in circuit board.

Delta Electronics had its RCS-1 remote control system, introduced earlier, which includes CRT read-out of all parameters, direct antenna monitor interface, modulation bargraph with peak flasher, and telephone coupler with voice synthesizer for voice interrogation.

Motorola demonstrated a number of the two-way radio systems for remote pickup and moving vehicles. Among them were the Syntor FM two-way radio, Micor base stations and repeaters, VHF mobile telephones, and the HT90 "Handie-Talkie" FM portable radio.

Marti Electronics was another firm long established in remote pickup and STL equipment with some new systems at the show. Introduced were two new telemetry links, Models TSL-2 and TSL-15, usable for remote control systems in AM, FM, and television. The TSL-2 transmitter has a power output

of 2.5 watts; the TSL-15 has 15 watts output. The receiver has 90 dB spurious signal rejection and adjustable squelch. The system handles analog or digital telemetry, or voice modulation, in the 20 Hz - 3000 Hz band. Marti will assemble complete systems including the Yagi antennas, cable, and so forth.

Marti also introduced the ARS-15, a new automatic repeater station for the 450-MHz band, with 15 watts output. And a third new Marti system was the STL-10, a completely new studio-transmitter link with state of the art specifications. The firm's STL-8, widely sold for nearly a decade, will still be available alongside the new system.

McMartin Industries, with a display strong on transmitters, consoles, and other systems, also showed its long-used remote pickup units, including the hand-held RPU portable transceivers.

Microcontrols Inc. had the wide-band composite STL system introduced last year, claiming very low distortion.

Hallikainen and Friends brought the digital telemetry systems for connection to various Moseley remote control systems, seen at earlier shows. The firm also had the new PCC process

control system for complete control and logging of transmitter functions.

Dictaphone showed improved versions of the "Veritrac" automated voice logging system. From four to 40 tracks of voice recording can be put on tape up to one inch wide. Recording time per reel is up to 25 hours. Auto search can find particular material by time/date access information.

For more information: TFT Inc. interface circuit, 386; TFT Model 8300, 387; TFT Model 8100, 388; Moseley Associates Model PCL-606, 389; Moseley MRC-2, 390; Potomac Instruments DAP-11, 391; Potomac SMR-11, 392; Marti Electronics Model TSL-2, TSL-15, 393; Marti ARS-15, 394; Marti STL-10, 395; Hallikainen and Friends PCC, 396.

Telco interface

Systems to improve the interface between the broadcaster and the telephone system continue to hold strong interest. Comrex introduced its most elaborate coupling system to date. Called the "SLX Frequency Extender", it is an encoding/decoding system like the very popular Comrex low frequency extender; but the SLX gives improved frequency performance at both ends of the spectrum. The remote unit includes a series of microphone and line inputs, and a four-channel mixer, together with the telco interface and a flexible control system, plus a headphone amplifier.

Telfax Communications had the somewhat similar TFX-31B, introduced earlier, which also has a four-circuit mixer with three microphone inputs and one line input, plus the self-contained hybrid and dial-up circuits. It includes a headphone amplifier, standard rechargeable battery, and visual and audible indicators for incoming calls. Telfax announced at the show a more elaborate model, the TFX-131, to be marketed in July, with four mic inputs, two line inputs, and pushbutton dialing, with pulse and touch-tone.

The Studer-Revox telephone hy-



New Comrex SLX frequency extender.

The new advanced design MQ-Series mixers.

RIGHT ON THE MONEY.

Introducing the MQ-Series. A new line of highly affordable mixers that refuse to compromise with audio performance. Or with your needs.

You get the tonal flexibility of a 4-band EQ on each channel and the added flexibility of per-channel echo and foldback

sends. Plus a pair of master-program 9-band graphic equalizers. And direct interface flexibility with per-channel dual input switching.

There's also the dependability and service convenience of a modular layout with each channel's components mounted on a separate internal printed

circuit board. The MQ-Series. Right on the money, right down the line.

Visit your Yamaha dealer or write us for more information. Yamaha, Box 6600, Buena Park, CA 90622. In Canada, Yamaha Canada Music Ltd., 135 Milner Ave., Scarb., Ont. M1S 3R1.

Combo Products

THE WAY IT WILL BE.

 **YAMAHA**

Circle 134 on Reader Service Card

www.americanradiohistory.com

THE PERFECT 29 SECOND SPOT



No-Cut Editing with The Lexicon Model 1200: saves time, saves reshooting, preserves program integrity

- *Compress takes that run too long*
- *Compress commercials to add tags*
- *Compress syndicated shows to add commercials*
- *Meet network/satellite time constraints*
- *Streamline post production editing*

The Lexicon Model 1200 audio time compressor/expander automatically controls the speed of record/playback equipment and preserves broadcast quality audio — for film, disc, tape and video tape. To use: enter actual play time, desired play time, press "GO". It's that simple.

Lexicon

60 Turner Street
Waltham, MA 02154
(617) 891-6790
TELEX 923468

Export Gotham Export Corporation, New York, NY 10014

Circle 135 on Reader Service Card

brid, in use for a couple of years, was also on hand. It has sidetone attenuation of up to 40 dB, plus a built-in limiter and white-noise generator.

For more information: Comrex SLX Frequency Extender, 397; Telfax TFX-131, 398.

Automation

Business and program automation systems now quite generally are applicable to both radio and television stations. Most firms established in this area keep refining and enlarging the capacities of their systems, but no radically new approaches turned up at the show. One trend was away from on-line, central-computer operation, toward having an in-house computer for each user.

Jefferson Data brought its ENP (Electronic News Processing) system as a market-ready product; the system has been in development at WBTV in Charlotte for a couple of years. ENP has four primary functions: News Watch, a computerized scanning of wires services and routing of stories to appropriate files, with instantaneous display of previously received stories; News Edit, a text editing system with

split-screen capability and electronic search and replacement of any word; News Pro, which handles all production functions including assignment sheets, producer's rundown, teleprompter interface, and hard copy script; and News File, which archives all ENP information. The system is now ready for sale to broadcast stations. It is a completely separate product from Jefferson Data's System 90 business automation system, which is still going strong and is in use at almost 100 stations, the company says.

The latest addition to Station Business Systems' BAT 1700 business automation system is a word processing function for either newsroom or business applications. A search function will find any word in the system; other

functions include insert and modify. The BAT 1700 system has been enhanced and upgraded, the company said; each internal program has been reworked for flexibility and additional features.

SBS was stressing its Attached Resource Computer (ARC) setup, which allows all the business systems to run at the same time. Each ARC supports up to 200 work stations and is expandable with additional ARCs. Each terminal has an internal computer with 60 to 256K of internal memory, so that jobs are performed inside the terminal itself, not at the CPU. Access is limited by codes that are locked up in the computer and cannot be changed unless the ARC is down, resulting in extreme security within the system, according to

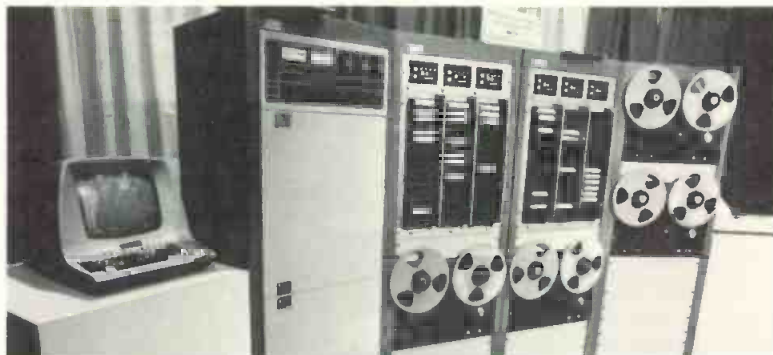

Complete program automation system from Cetec.

NOW! CONTINENTAL'S 1 KW AM



Pulse width modulation in an efficient 1 kW package; efficiency and reliability of a tube-powered final; clear, crisp sound of transformerless modulation; ready for AM stereo. Switch-mod system allows maximum modulation level at all power levels while providing cost-effective operation.

Write for brochure on 314R-1:
Continental Electronics Mfg. Co.
Box 270879 Dallas, TX 75227
(214) 381-7161

Continental Electronics

Circle 136 on Reader Service Card

NEW-SYSTEM 14



Broadcast Audio Corporation introduces the SYSTEM 14 Digitally Controlled Stereo Audio Console. A digital slide fader and CMOS digitally controlled high resolution logarithmic audio attenuator significantly reduce signal paths, without the numerous disadvantages associated with VCA's.

Options include 5-frequency EQ on each mixer, Pan Pots, Remote Line Selectors, Talkback and Test Oscillators. Standard features include separate mic/line preamps on each mixer and 3 stereo mixing busses.

Base price for a complete 8 mixer SYSTEM 14 is \$11,500.00. Delivery is 60 days ARO.

11306 SUNCO DRIVE
RANCHO CORDOVA, CA 95670
(916) 635-1048

**BROADCAST
AUDIO CORPORATION**

Circle 137 on Reader Service Card

the company. Installation is simple since all hookups require only a power cord and coax.

SBS was one of the firms moving toward the in-house computer.

McInnis-Skinner and Associates showed a **teleprompter interface** for its Newscan automated newsroom system. The system has had this capability all along, the company notes, but this was the first time it was displayed. The system is available in several configurations: news-only; Weathergraphics-only; with full news, weather, and graphics capabilities; and as a library/archive system. Just before NAB the company sold its first newsroom system to WBNS-TV, Columbus, OH, which had built a computer-ready newsroom three years ago and already had Weathergraphics.

Columbine Systems, Inc., had several new **software functions** for its radio and television business automation system, now installed in over 500 U.S. stations. The new software includes film amortization, media inventory, music rotation, an automation interface, and demographics.

Kaman Sciences, which has promoted the BCS system at past NAB shows, this year described a large broadcast business system it plans to



IGM cart equipment under microprocessor control.

introduce at next year's NAB. Based on the IBM System/38 computer, the new system will offer traffic, billing, and accounting packages and will feature true interactive databases, according to a company spokesperson. Kaman, too, is shifting to the large in-house computer.

The new item from **Harris Corp.** was an office automation **Infewriter**, a tabletop word processor with floppy disk memory and a typewriter-quality printer. The company says the Infewriter can be used for music lists, news, and business functions. It can in-

terface with the Autotron Star system, shown this year with a high-speed printer. The company also brought its full 9000 program control system, including a satellite configuration.

Data Communications Corp. once again featured its modular Network Control System, which incorporates the BIAS traffic system, Buy Line, Master Control Automation, and several other functions. The company's main emphasis this year was on the system's in-station functions.

Also seen before was the **Cado Systems** business computer, with software

At Broadcast Technology There's A Lot More Behind Us!

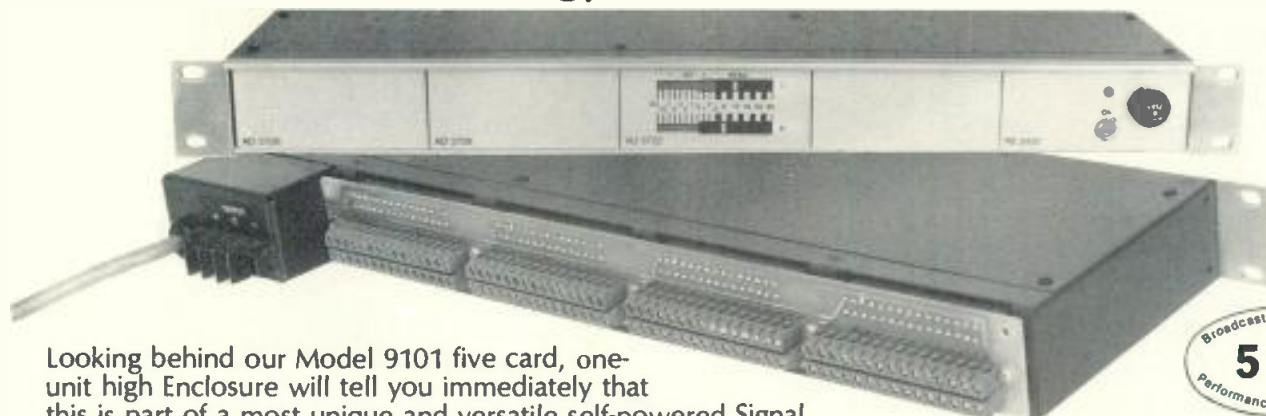

Looking behind our Model 9101 five card, one-unit high Enclosure will tell you immediately that this is part of a most unique and versatile self-powered Signal Processing System with barrier type terminals. By simply plugging in any of the BTI Series 3000 Cards, the system becomes a D.A., Switcher, an Intercom, an Equalizer, one or more Line, Power, or Pre-Amplifiers. The VU/Peak Level Indicators provide continuous in-line displays of VU and Peak information over a wide range of "0 VU" for all system configurations.

What's behind Broadcast Technology is more than meets the eye. We are seasoned audio professionals who are committed to technical excellence in the design and manufacture of audio components and systems.

There is also more behind our products as evidenced by our exclusive 5 Year Performance Warranty.

Look at us, and then look behind us. You'll find a lot more at Broadcast Technology.

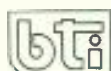

broadcast technology inc.

33 Comac Loop, Ronkonkoma, NY 11779 (516) 588-6565



Circle 138 on Reader Service Card

developed by **Chase Media**. A Chase spokesperson said the system was constantly being upgraded and revised. The company has about 70 installations, including two in Australia and one in Peru.

Quanta Corp. was back with its Quantanews computer-assisted newsroom system, which handles wire services, printers, archives, prompting, assignments, and other functions. New software permits each user to define his or her own filing and housekeeping systems. All entry terminals are interchangeable for redundancy and backup; all include an eight-inch floppy disk that automatically copies everything sent to the archive. The system is fully expandable and features user-definable security and privilege levels.

BEI returned with its Data-Prompter electronic newsroom system, a word processor that allows assembly and editing of copy with hard copy printouts. The system will handle multiple edit terminals for entering and storing information; it can also include an encoder for Line 21 closed captioning.

Cetec, long known in program automation, moved strongly into business automation with the introduction of the new, compact **MAPS**, with all hardware in house, aimed at compactness

and low cost. Included is a mini-computer, a Digidyne system, with Western Dynex hard-disc storage for 10 million characters, plus video read-out and hard-copy printer. Cetec says the system will instantly deliver any of 200 reports needed in running a radio business.

One company that was thinking small was **Generic Computers**, which introduced **Applelog**, a scheduling and accounting software package for the Apple 2 personal computer. The system is on hard disks, with a floppy as backup. Price for the entire system—including the computer, color display, printer, hard disk, and backup floppy—is \$14,500, including installation.

Another small system was shown by **Personal Micro Computers, Inc.**, a subsidiary of Recortec and sharing that company's booth. The company introduced its **EPS-80** word processor, available with or without a printer or typewriter interface. Storage is on low-cost audio cassettes.

Mead Data Central described its Nexis database service. The customer's desktop terminal (with or without printer) gives access, through telephone lines, to Mead's database, which includes the major international news services.



Sono-Mag Corp. program automation controller.

Interactive Market systems came to its first NAB show with a description of its research and sales presentation services and of its computer color graphics package.

Computer Concepts Corporation, another "in-house" automation supplier, uses a Wang computer and has developed complete software for traffic, accounts receivable, payroll, and so forth, together with a Music Management System which holds all relevant information on up to 65,000 titles. Any kind of music wanted can be accessed instantly through the system.

The Affordable, Professional Reverb.



The Orban 111B has become an industry standard for some very good reasons: it's an affordable, reliable reverb that complements your sound instead of muddying it. Orban's broadcast-quality construction, unique signal processing, flexible equalization, low noise, and extensive RF-proofing make the difference. Unlike cheaper reverbs, the 111B is a unit you'll want to live with long after the honeymoon is over. And you can pay more without getting the 111B's bright, transparent sound.

You'll find that sound ideal for both program line enhancement and production use. The Orban 111B is the reverb of choice for the demanding broadcaster—it gives the polished, professional touch to your in-house spots and promos. Call your local Orban dealer today and find out more about the practical, professional 111B.

orban

Orban Associates Inc., 645 Bryant St., San Francisco, CA 94107 (415) 957-1067

Circle 139 on Reader Service Card

Think of us as your mike expert.



The 635A – Perfect design from the start

The Electro-Voice 635A is probably the most widely used broadcast microphone currently available. Yet it was introduced back in 1967! There are microphone companies that haven't been around as long as the 635A! What makes a microphone continue to be the broadcasters' favorite after 15 years in the field?

The 635A was designed to be used anywhere. Its screw-machined steel case and mechanically nested parts set standards for durability and ruggedness that the competition still strives for. It was the first omnidirectional microphone designed to have a shaped, rather than flat, frequency response. A rolled off bass response combined with a slightly rising high end make it perfect for vocal reproduction. And it was the first microphone of its type to feature an elastomer

encased head capsule for reduced handling noise and additional protection from severe mechanical shock.

Despite all the technological advances in the broadcast, recording and sound reinforcement industries, the 635A continues to be the "audio man's screwdriver" - a microphone tool that can be used anytime, anywhere, for almost anything. When a product is designed right to start with, there's no need for it to become obsolete. All Electro-Voice professional microphones are designed with the same goal in mind. That's why people think of Electro-Voice as their microphone expert.



600 Cecil Street, Buchanan, Michigan 49107

In Canada:
Electro-Voice, Div. of Gulton Industries (Canada) Ltd.,
345 Herbert St., Gananoque, Ontario K7G 2V1.

Circle 140 on Reader Service Card

www.americanradiohistory.com

Program automation looked active, strong. As noted in last month's report on satellite developments at the show, virtually all the makers of radio program automation systems brought special systems or software for automating format programming as received via satellite. Broadcast Electronics, Cetec, Harris, IGM, Sono-Mag, all had such systems. In addition, all, of course, showed the radio program automation systems in their established lines. In the cases of Cetec and Harris, the double emphasis on both programming and business automation was evident.

For more information: McInnis-Skinner and Associates *teleprompter interface*, 399; Columbine Systems, Inc. *software functions*, 400; Harris Corp. *Infowriter*, 401; Cetec *MAPS*, 402; Generic Computers *Applelog*, 403; Personal Micro Computers, Inc. *EPS-80*, 404.

Test and measurement

The order of the day at the 1982 show was the programmable instrument incorporating digital technology and portable size to accommodate the increased use of field equipment. The new **TM 5000 Series** of digital multi-meters from **Tektronix** was shown with eight different programmable digital units with scanner interface. The **Tek 465B Series** of portable oscilloscopes have upgraded performance, while the **468** was a portable digital storage scope using an eight bit digitizer for 10 MHz bandwidth.

In test system equipment, **Amber Electro Design** featured the **4400A** multipurpose test set which provides a generator, a receiver, and a meter section. **Sound Technology** brought the **Model 1500A** tape recorder test system which measures nine parameters and also showed the **1501A** balancing system.

AWA Instruments, on display at the Marconi/A.F. Associates booth, drew interest with the audio transmission test system **S1100**. In four seconds it tests 38 separate measurements, and overall measures 51 significant transmission parameters. Measurements are stored and printed with date, time, and source identification code.

Belar Electronics showed its frequency response and modulation monitors including the stereo version which measures FM and AM noise as well as incidental AM on the front meter panel. **Autogram** had the T-8 frequency response test set for broadcast which contains eight preset switchable sine wave audio frequencies.

Fidelipac's wow and flutter meter checks cyclical variations in carts, reel-to-reels and audio cassette recorders as

well as video tape machines, turntables, and film projectors. The **UniVUer** from **Real World Technology** produces a two-channel bar graph display with graticule markings, keyed over a video monitor, and acts as a unified reference point for total program monitoring.

Audio test and repair equipment was displayed by Pace along with its training program for repair services. Spencer Broadcast brought its **EFI** combination transient protection system which measures both disruptive (RFI, powerline noise) and destructive (switching, over-voltages) sources.

McCurdy's extended range audio level meter measures peak and average audio transmission level in dBm with a two-position range switch for different audio input levels.

A full discussion of test and measurement equipment for the RF environment will be found in next month's issue.

For more information: Tektronix *TM 5000 Series*, 405; Tek *468*, 406; Amber Electro Design *4400A*, 407; Sound Technology *Model 1500A*, 408; AWA Instruments *S1100*, 409.

Other

Sescom displayed its wide range of instruments, transformers, and accessories. **Wireworks** collection of audio and video cable and junction boxes were on hand. Audio patchfields were shown by **Farrtronics** and **ADC**, while **Canford Audio** brought its line of color coded wire. Other wire accessories included **Neutrik's** audio connectors.

Prewired jackfields were at the **McCurdy** booth, and **Broadcast Technology**, brought its full array of card frames. **BEI** showed rack frames and input cards. **Stantron's** data terminal desk system was on display along with the full line of electronic cabinets and peripheral furniture. Also at the show was **Allied Broadcast Equipment's** telephone equalization equipment.



Sonex soundproofing demo at Alpha Audio booth.



Wireless Microphone



Professional

Eastern Acoustic Works, Inc.



**MAIN DEALER IN THESE
AND MANY OTHER
FINE LINES
COMPLETE SYSTEM DESIGN
AND INSTALLATION.**

**HARRIS AUDIO
SYSTEMS, Inc.**

1962 N.E. 149 St., N. Miami, Florida 33181

(305) 944-4448 **SOUND EAST**

Michael Harris

Circle 141 on Reader Service Card

Prime Time

For information on the products or services mentioned here, contact your RCA Representative. Or write RCA, Prime Time, Bldg. 2-2A, Camden, NJ 08102.

Battery Of TR-800 VTRs In Use at Dallas NAB



Seven TR-800 1" Type C Helical VTRs were in action at NAB, including three consoles that were demonstrated with the CMX-340A computerized editing system. Two other consoles were equipped with the AE-800 editing system.

"I Love The TR-800"

A host of users were presented in an audio-visual show in which they commented on their experiences and expectations with the TR-800. These included statements like "the machine is very flexible"; "I like the back-up service I can expect from RCA"; "It's far gentler on tape than any other machine we've experienced"; "It's an operator's machine"; "I love the TR-800".

Customers from London to Egypt to South America to the U.S. are using TR-800s in post-production, video playback, sports programming and specialized applications. You should get all the facts on this advanced 1" VTR. Ask your RCA representative.

NAB REPORT

RCA UNVEILS NEW EQUIPMENT AND SYSTEMS



NAB '82 in Dallas was an exciting event with over 480 exhibitors vying for attention. RCA used the forum for the introduction of new equipment (a VHF transmitter, TK-47B and TK-710 live cameras, a new TK-290 automatic telecine camera, VHF and UHF antennas); and to announce new improvements in existing products

(Hawkeye recording camera system, TR-800 VTRs).

In this issue of Prime Time, there are brief reviews of all of these equipment and system availabilities. Space prevents more than these capsule reports, but for more information on any of these products, contact your RCA representative or write to RCA.

New 35kW Transmitter; New VHF and UHF Antennas Introduced

The TTG-35H is RCA's newest G-line member. It's a single-ended 35kW VHF solid state transmitter with only two tubes. All circuitry is solid state up to the 1600 watt visual and 100 watt aural driver output levels.

Two New Antennas

The THP VHF Antenna is a horizontally polarized unit covering channels 7-13. It's suitable for multiplexing several channels within the 174 to 216 MHz band.

Also unveiled at NAB was the TFU-33JN, a new standardized omni-directional UHF pylon antenna designed for intermediate power ratings up to 60 kW. It retains the features of all RCA pylon antennas (over 500 built and delivered)—slotted steel pole construction, low windloading, immunity to lightning and icing.

For transmitter and antenna data, contact your RCA representative or write RCA.

Telecine Camera Goes "Automatic"

RCA introduced the TK-290 Automatic Telecine Camera at NAB. It is a microprocessor controlled system that utilizes the same set-up terminal as the TK-47 studio camera. The two systems—studio and telecine—are completely compatible and cost effective. A single set-up terminal can be used for up to twelve TK-290 and TK-47 cameras.

The set-up system utilizes both the "Autocam" option and the "Check" function. "Autocam" provides total automatic set-up and "Check" initiates a daily cycle of pre-operational functions.

Send for complete details on this new automatic telecine system. Or check with your RCA representative.



HAWKEYE Recording Camera System In Smash "Take Me Home" Demo

"I see, it's a kind of build as you go system," said Jumpcut. "Exactly," responded RCA's narrator, "and, best of all, it's ready for delivery now."



RCA narrator and Jumpcut Jennings discuss HAWKEYE.

An entertaining presentation of the HAWKEYE Recording Camera System drew crowds at NAB. A live demonstration of the HCR-1 recording camera highlighted the presentation as an RCA spokesperson described new accessory options and HAWKEYE's "build as you go" advantage.

HAWKEYE options include playback through the camera's viewfinder, triaxial cable operation, and multi-core cable remote control capabilities.

The system's high performance HC-1 camera, HE-1 editor, compact HR-1 portable and HR-2 studio ChromaTrak format recorders were integral to the presentation in explaining how these components could be added to existing operations one by one to build a HAWKEYE system in easy stages.

Delivery Now!

RCA emphasized its "ready for delivery now" message with a wall of 10 recording cameras, 21 studio recorders and 7 editing consoles with a sign which read, "Take Home a HAWKEYE."

Displayed in other areas of the exhibit were HAWKEYE HR-2 recorders linked to a CMX time code editing system, a triax-equipped HC-1 camera with optional 4.5" viewfinder, and a fully equipped HAWKEYE pro-



Hawkeye recording camera in live NAB demonstration.

duction van. The van will be touring the country in the next few months. Contact your RCA representative for a tour schedule and HAWKEYE system details.

New Hawkeye 1/2 Inch Format Submitted To SMPTE

A proposed standard for broadcast quality half-inch video tape recording has been submitted by RCA to the Society of Motion Picture and Television Engineers.

The format, called ChromaTrak, is a baseband recording technique using half-inch video tape in standard 250 meter VHS cassettes. The format is used in the Hawkeye system which includes the HCR-1 recording camera; the HR-1 portable recorder; and the HR-2 studio recorder.

Three other camera manufacturers made submissions to SMPTE on this same basic format.

ChromaTrak provides performance better than 3/4 inch recordings and approaches 1 inch quality.

For a copy of the "Interchangeability Specifications" and a paper on "An Introduction to ChromaTrak Recording," contact your RCA representative.

New TK-47B, TK-710 Cameras Debut In Studio Demos



TK-47B Camera

The TK-47B Automatic Color Camera presentation featured a demonstration of its optional microprocessor-based "Smart" RCU. It retains all camera control functions plus a memory capability for file and recall of selected "paint" control settings for up to 32 different scenes.

TK-710 Camera

With three Saticon tubes and high index Canon prism optics, RCA's new low cost TK-710 Portable Color Camera delivered broadcast quality pictures consistently



in demos. This new lightweight consumes a mere 20 W power and is equipped with a Fujinon 14x10 servo zoom lens.

TK-761 Camera

Also shown was the TK-761, a proven performer. It's a multi-purpose camera, widely used for quality programming in the field and in the studio.

RCA

Introducing the New CHYRON® IV.

The New CHYRON Adds True Graphic Capabilities To The World's Leading Character Generator.

The latest Chyron is the system that the broadcast industry has been waiting for. You have known the Chyron IV as a powerful character generator that's easy to use.

Now, utilizing advanced computer graphics, it has become a flexible graphics tool, as well. The result: a truly versatile graphics generator that provides virtually all of the electronic functions you need. And, it's still easy to use!

More Artistic Freedom

CHYRON IV's digitizing tablet provides full flexibility for the artist to draw, change select colors and fill. He has,

in effect, a true electronic paint system. *Background graphics* can be created and displayed or stored for later use. In addition to the digitizing tablet, graphic information can be entered with a black and white camera in the font compose mode.

This new background graphics capability gets the artist away from plain text into the generation of "pictures": graphic images, representa-

tions, vignettes with as many as 16 colors or gray scale values, etc.

Multicolor characters are available, too. Full color or halftone artwork is digitized and displayed with up to several different color values per character. The display can be changed from *gray scale values* to *psuedo-color* for ease of trim and area identification. This means that multicolor logos or other artwork can be displayed and treated as a single character to take advantage of all the CHYRON IV animation and character manipulation features.

New Board is the Key

A state-of-the-art multimode graphics module is the heart of the new capabilities. It replaces the existing font compose module and operates in several differing modes.

In its basic operation, the new module provides an advanced means of camera font compose. A built in A/D converter samples incoming camera video at 10 times subcarrier and digitizes each sample with four-bit accuracy (thus, the 16-level gray scale). Software then analyzes the data to produce extremely smooth curves and slopes for virtually perfect capture and the elimination of trimming in most cases.

Many Other Features

Other CHYRON IV features provide even more flexibility. Up to four "vignettes" may be created and independently positioned or animated. Text can be moved out of the safe title area, the color palette has been expanded to 512 choices, character edging can be any color and diagonal typing has been provided. The roll and crawl modes have been improved to allow smooth motion through horizontal and vertical blanking. And there's more. Call or write for all the details.

The CHYRON® COURIER

An Occasional Newsletter
Dedicated to the Latest
Chyron Developments.

Vol. I, No. 1

Earlier CHYRON IV's Can Be Retrofitted for New Features

The new CHYRON still carries the model number IV. It will not obsolete the many earlier CHYRON IV's still serving nobly out in the field.

Your current CHYRON IV can be retrofitted to provide all of the newly-developed features. Return your IV to the factory, and we will replace the unit's present font compose module with the new multimode graphics module and add the necessary systems modifications to accept the new features. It will convert your old CHYRON IV into a true graphics generator, with all of the many advantages of the new model.

Updated training sessions will be available, too. Classes for operators may be scheduled at Chyron headquarters in Melville, N.Y. or at your place of business.

For details on the retrofiting of your earlier CHYRON IV and on the latest operator training, call or write today.

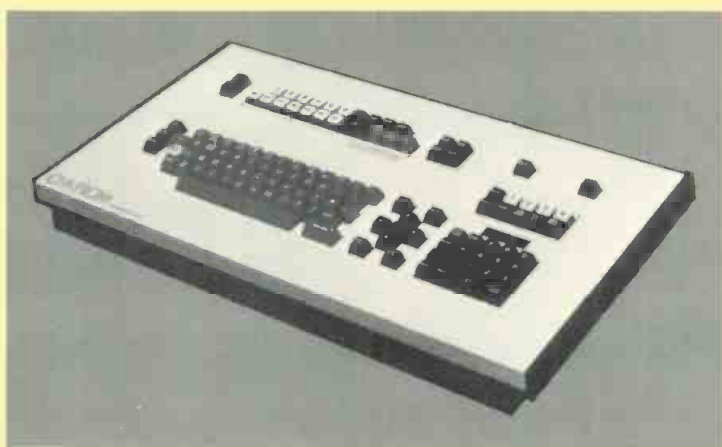

Highlights of the New System

In brief review, these are the main features of the new CHYRON IV.

- Background graphics plane
- Advanced font compose with 16 levels of gray scale
- Multicolor characters (7 colors each)
- Digitizing Tablet
- Winchester disc
- 512 color choices
- Four-level animation plane
- Blanking-to-blanking display capability
- Colored edge
- Fader provides 256 levels, with gamma correction (pre-programmable)
- Diagonal typing
- Software-based for future enhancements.

Follow the Leaders with
CHYRON
TELESYSTEM

A DIVISION OF CHYRON CORPORATION
265 Spagnoli Road, Melville, New York 1174
• 516-249-3296 • Telex: 144522 Chyron Me
Ampex International is exclusive distributor for
Chyron Graphics Systems outside the U.S.A.

1982 NAB Show-In-Print

VIDEO

Camera overview

Television camera designers never rest, and the 1982 NAB Convention provided ample evidence of this truism. For one thing, practical solid-state cameras edged closer. Hitachi unveiled a three-element metal oxide semiconductor (MOS) design with better than 450 TV lines of resolution. It will reach the market this fall. NEC demonstrated a two-chip CCD unit that attendees found remarkably good. EEV Inc. showed that it is in the field by demonstrating a monochrome unit.

ENG cameras got better, cheaper, and smaller as shown by new models from Bosch Fernseh, Harris, Ikegami, JVC, Panasonic, Sharp, and Sony.

And cameras got smarter, as evidenced by Philips' new LDK-6 intelligent camera system using computerized distributed processing. Some got more like film cameras, to judge by the new Foton-I developed by CEI in conjunction with Panavision.

RCA added refinements to make both Hawkeye and the TK-47B automatic easier to use. Ikegami offered third-generation automation features in its recent HL-322. More flexibility was the hallmark of two other new cameras at NAB, the Thompson-CSF TTV 1525B and the Bosch KCI-90 automatic, which, like the 1525, uses a one-inch tube for luminance and 2/3-inch tubes for chrominance. In fact, Toshiba and Ampex were the only manufacturers not to show something brand new, though Ampex did report the BCC-21 convertible studio/field model was now ready for delivery.

Recorder/cameras

Previews of the 1982 NAB Convention promised a showdown of sorts in the integrated recorder/camera competi-

tion with new contestants likely taking sides on which 1/2-inch format they preferred—RCA/Matsushita VHS or Sony Beta. Unexpected was Bosch Fernseh, showing up with yet a third format (or perhaps fourth, counting the Nippon Television Network's CV-One seen at NAB-81 and reappearing in 1982 in the Hitachi stand). In a real sense Bosch Fernseh captured the spotlight even though Ikegami and Hitachi did come down on the RCA/Matsushita VHS side. It did so by promising the best yet in terms of size and weight and recording performance "better than 3/4-inch U-matic." Although Bosch Fernseh uses the 1/4-inch CVC cassette, as does the CV-One, Bosch came up with its own Lineplex format to deliver a quality picture (see specs below) comparable to that achieved by RCA's Chroma Trak and Sony's Betacam.

To be sure, RCA was the most aggressive manufacturer at NAB. Boasting that its unit is already in production, RCA said, "Take home a Hawkeye" and lined up 21 units for off-the-shelf delivery. Matsushita/Panasonic came on strong this year, tagging its system, also ready for delivery, the ReCam. The 1982 ReCam model B-100 included a new camera head, the AK-100, using either 2/3-inch Saticons or Plumbicons, with all of the features demanded by broadcasters. Panasonic also offered an AU-S100 adapter so that the recorder could be wired to any other camera.

But for all of the RCA and Panasonic promotion, including both recommending their joint format to the SMPTE as a 1/2-inch standard along with Hitachi and Ikegami, any bandwagon for a new system was not in evidence. Sony implied that the time for a Betacam is still in the future, unless one is willing to work with a one-tube camera. Sony did promise a professional high resolution, low registration error, three-tube camera head later (using 2/3-inch tubes) but at NAB showed a mockup model only.

Camera overview	71
Recorder/cameras	71
Solid-state cameras	72
ENG cameras	74
Computer-aided cameras	74
Lenses	78
Telecines, film	79
VTRs	80
Videotape, accessories	82
Slow motion recorders	83
Digital art and graphics	84
Character generators	90
Production switchers, special effects	95
Digital effects, still stores	98
Master control, automation	100
Business automation	Audio section p. 63
Post-production	103
Time code	106
Digital signal processing	110
Pulse and sync	114
Routing switchers	114
Test and measurement	119
Monitors	122
Lighting, sets	122
Power	126
Camera support	131
Racks, cases, furniture	134
Satellites	May issue, p. 79
RF equipment	July issue

Developments in recorder/
camera combinations

(clockwise from upper left):
Part of the modular
electronics package for the
Fernseh KBP-1; the
Fernseh camera itself;
Panasonic's ReCam;
Hitachi SR-10 with
Matsushita/RCA
recorder format.

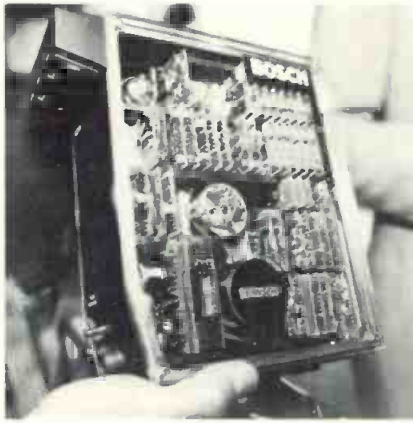

For its entry, Ikegami simply outboarded its version of Chroma Trak (called the M format by Panasonic) on the side of an HL-83 ENG/EFM camera. It further diffused its position by reporting customers could outboard a 1/4-inch recorder if they wished.

Hitachi's entry, the SR-10, was well styled but the camera head was the new unproven (albeit impressive) MOS solid state unit, the SK-1. As we note later, this camera does not meet highest broadcast standards. Hitachi said it was in the camera/recorder market but would make no strong move until a standard emerges. Underscoring the uncertainty in this market, Hitachi displayed (but did not demonstrate) the CV-One built for Nippon Television. This package also used a solid state camera (presumably the SK-1). The VTR portion uses a linear format,

called Fotomat, providing but eight minutes of recorder time. This camera will be marketed by Nippon TV rather than Hitachi.

Called the most compact TV news gathering system yet, Bosch's KBF-1 total package of recorder-camera including lens, viewfinder, battery and cassette weighs only 15 lbs. This low weight was achieved not only as a result of the lighter 1/4-inch cassette, but through extensive use of LSI chips, hybrid printed circuits, and new lightweight structural materials. The camera head is all new, incorporating three 1/2-inch Plumbicons. Although the VTR portion uses the Funai threading mechanism made in Japan, everything else is Bosch. The format is two track, luminance and chrominance, with bandwidths of 3 MHz and 1 MHz respectively. Bosch has taken the "color-under" approach in contrast to the Chroma Trak and type M direct FM re-

coding. In the NTSC standard, luminance S/N is 47 dB; chrominance 45 dB. Playing time at present is 12 minutes, but new tape could extend that. At NAB, only the recorder portion was demonstrated, but a final product will be ready this year, the company said.

Camera pickup tubes for the new recorder/camera packages also continue to advance. AmpereX, which has been in the field almost from the beginning with its hybrid 1/2-inch diode gun 80XQ Plumbicon, was joined this year by EEV, which had a new 1/2-inch Leddicon.

For more information: Sony Betacam, 410; RCA Hawkeye, 411; Panasonic ReCam, 412; Ikegami 83 with recorder, 413; Hitachi SR-10 recorder/camera, 414; Hitachi SK-1 solid-state camera, 415; Bosch KBF-1 1/4-inch recorder/camera, 416; AmpereX 1/2-inch diode gun 80XQ Plumbicon, 417; EEV 1/2-inch Leddicon, 418.

Solid-state cameras

The NEC Model NC-2000 color camera using two CCD image sensor chips showed advances in sensitivity and resolution, two problems encountered heretofore with solid-state pickup cameras. Resolution is satisfactory; the G channel has 489 V and 384 H pixels, resulting in a horizontal resolution of 240 or more TV lines. Sensitivity is remarkably good because photo diodes have a high response to blue. The camera is rated a f/4 at 1200 lux and outperforms vidicon cameras in lag. There is, of



RCA Hawkeye recorders line the shelf.



New developments in AmpereX Plumbicons.

Ampex Announces the Practical End of Video Jitters.

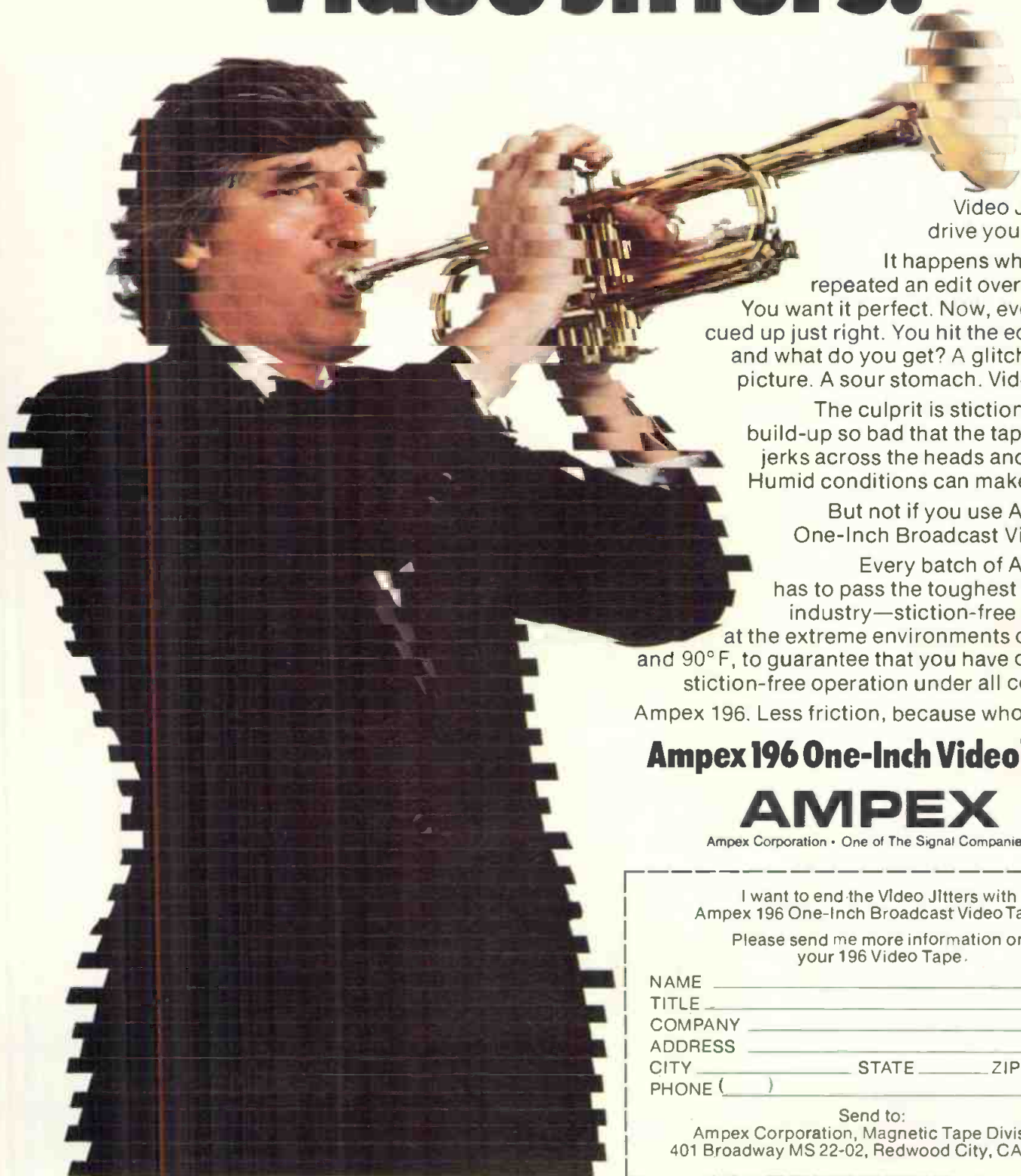

Video Jitters can drive you up a wall.

It happens when you've repeated an edit over and over. You want it perfect. Now, everything's cued up just right. You hit the edit button, and what do you get? A glitch. A shaky picture. A sour stomach. Video Jitters.

The culprit is stiction—friction build-up so bad that the tape actually jerks across the heads and scanner. Humid conditions can make it worse.

But not if you use Ampex 196 One-Inch Broadcast Video Tape.

Every batch of Ampex 196 has to pass the toughest test in the industry—stiction-free operation at the extreme environments of 90% RH and 90° F, to guarantee that you have consistent stiction-free operation under all conditions.

Ampex 196. Less friction, because who needs it?

Ampex 196 One-Inch Video Tape.

AMPEX

Ampex Corporation • One of The Signal Companies 

I want to end the Video Jitters with Ampex 196 One-Inch Broadcast Video Tape.

Please send me more information on your 196 Video Tape.

NAME _____
TITLE _____
COMPANY _____
ADDRESS _____
CITY _____ STATE _____ ZIP _____
PHONE () _____

Send to:
Ampex Corporation, Magnetic Tape Division
401 Broadway MS 22-02, Redwood City, CA 94063

BME

course, no geometric distortion, and no sticking or burn-in with solid-state pickups.

The **Hitachi SK-1**, using three MOS image sensors, claims a higher resolution of 450 lines, but poorer sensitivity—*f*/3.5 at 2000 lux. Pictures can be taken, however, with minimum illumination of 100 lux at *f*/1.4. Hitachi says the after image is lower than that of other solid-state cameras. The picture quality shown at NAB looked quite close to that of tube cameras. The camera is expected to be on the market in 1982 priced at \$20,000.

RCA has apparently dropped out of the CCD broadcast camera picture for now, concentrating on an industrial, heat-sensing CCD chip.

For more information: NEC NC-2000, 419; Hitachi SK-1, 420.

ENG cameras

Offering a choice of either 1/2-inch Plumbicons or Saticons and using LSI chips extensively, **Harris** entered the ENG competition with its **TC-90** camera which weighs only seven lbs—the first three-tube ENG/EFP to be that low. A two ampere-hour battery will operate the camera for 1.3 hours. Specs equal the best: 600 lines resolution, S/N better than -57 dB, usable pictures under 5 fc, plus the usual automatics. Extensive use of LSI chips provides “unmatched stability,” according to Harris.

ENG cameras continue to be price sensitive. For example, **Sharp** in its new full-featured **XC-800** camera uses Saticon II tubes (with bias lighting) but manages to keep the price under \$13,000. Included are DBO, two-line enhancement, noise coring, automatics, and prism-sharp optics.

Ikegami, eyeing the under-\$10,000 market, has come out with the **ITC-730**, a prism camera with 600 lines resolution and a lot of features. Although priced lower, it is not quite as sensitive as the **XC-800**.

Also in the same class (600 lines res-



Harris Corp.'s TC-90 ENG camera.



ITC-730 prism camera from Ikegami.



Anton/Bauer's camera controller.

olution) is an upgraded **JVC** camera, the **KY-2700A** with an improved matrix mask and an automatic black level circuit with master black control (which permits simultaneous adjustment of red, blue, and green black levels).

Panasonic came out with a moderately priced prism camera, the **WV-777**. It offers automatics plus convenience features such as intercom level control, microphone gain, color bars, and RS-170A sync with genlock.

A unique camera controller for ENG cameras was announced by **Anton/Bauer**. The unit saves money by eliminating costly multi-core cabling.

For more information: Harris TC-90 421; Sharp XC-800, 422; Ikegami ITC-730, 423; JVC KY-2700A, 424; Panasonic WV-777, 425; Anton/Bauer camera controller, 426.

Computer-aided cameras

The **LDK-6** computer-controlled camera system introduced by **Philips** takes the concept of automatics a step further. Not only is automatic setup possible, but control and diagnostics are offered to a degree not heretofore possible. Philips says the **LDK-6** makes possible for the first time system information interchange, through individual microcomputer control systems located in each of the four main system units.

The distribution of intelligence between the main system units—the cam-

era head, the CPU, the Master Control Panel, and the Common Control Panel—ensures that settings and adjustments are processed locally and retained in the memory at the required location. Designed exclusively for triax operation, the **LDK-6** uses quadrature modulation of R and B, providing wideband RGB outputs for long cable runs. To insure consistently high quality pictures, the **LDK-6** uses digital scan correction. The picture is divided into 49 discrete areas and each is examined and adjusted so that corner errors are a thing of the past.

Philips also used the NAB Convention to promote the **LDK-44** modular camera system, introduced at the International Television Symposium in Montreux in 1981.

The intelligent camera was not limited to Philips. **RCA** offers a new **SMART** remote control unit (**SCRU**) to the **TK-47B** automatic studio camera. The **SCRU** remembers all camera control functions including color temperature, screen contrast compression, and so forth, and can file and read up to 32 selected “paint” control settings. Through new hardware and software, **RCA** also provides lens correction files that compensate for differences between diascope and through-the-lens viewing.

Ikegami's third-generation automatic camera, the **HK-322** introduced last year, is now ready for delivery. It also offers some preset special effects (up to eight) which can be stored and retrieved.

This year **Bosch Fernseh** entered the automated camera market with its **KCI-90**, a unit intended for both studio and field applications. Some 21 camera parameters can be lined up in approximately one minute using the automatic setup option. A registration-only check list can be run through daily. The **KCI-90** uses a combination of one-inch and 2/3-inch tubes to optimize sensitivity, lag, and noise performance.

Automatic setup cameras, all described in earlier issues of *BM/E*, could also be seen at the exhibits of **Ampex**, **Harris**, **Hitachi**, and **Toshiba**.

The role of the microcomputer fig-



Philips LDK-6 (with Canon lens).



VIDIFONT® GRAPHICS V. The excitement radiates through your creative staff. Reaches out. Grabs your audience. Vidifont Graphics V™ refines the art of electronic graphics. From often-needed name supers to story highlighters to full animated sequences. Imagine the added impact!

You start with distinctive graphic composition capabilities. With digitizing tablet or keyboard, design and create character fonts, logos, weather symbols and other graphics.

Add color. Over 4,000 colors for those multi-colored characters, extended edges, banners, backgrounds and graphics you could never before create in-house.

Now get things moving. With animation, color cycling and mix effects, including wipes, fades, mixes and merges. Our multiple plane frame-store means freedom of movement for rolls, crawls, character-by-character ripples and diagonals and full-screen animations.

Graphics V is a multi-channel system that welcomes simultaneous multiple-user access. Two high resolution channels and six off-line entry channels provide enough operating positions to custom fit your needs, including elections and other special programs.

For all its features and flexibility, Vidifont Graphics V is user-friendly. In the studio or on the road, operation is easy and efficient. Real-time productivity is the result.

Call or write Thomson-CSF Broadcast, Inc., 37 Brownhouse Road, Stamford, CT 06902. Tel. (203) 327-7700. TWX: (710) 474-3346.

 **THOMSON-CSF BROADCAST, INC.**

Generate excitement!



IF IT WERE YOUR JOB TO GET THIS ON TAPE, WHAT TAPE WOULD YOU GET IT ON?

For the first time, mankind will set foot on a surface other than earth. It's a moment that transcends science and politics. A moment that will be seen and reseen all over the world for as long as mankind exists.

But there are no guarantees at a moment like this. And the stakes are just as high for failure as they are for success. So nothing is left to chance.

That's why Scotch® Video Tape was there when the Moon Walk was first recorded. And again when the Space Shuttle Landing was first recorded. And again when the U.S.-Russia Hockey Game was first recorded.

The Papal Tour of America. The Return of the Hostages. The Eruption of Mount St. Helens. Whenever there was one chance to get it, chances are they got it on Scotch Video Tape.

So whether your production is important to the world or just important to you, why take chances? Get it on the one tape you know will get it right.

Magnetic A/V Products Division/3M.

Moon Walk
July 20, 1969

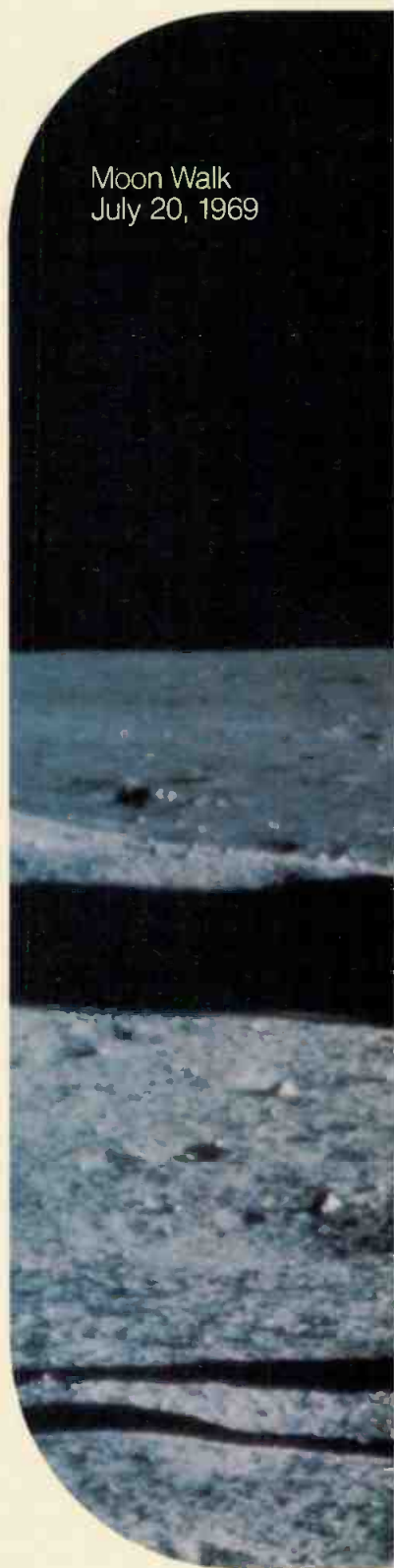

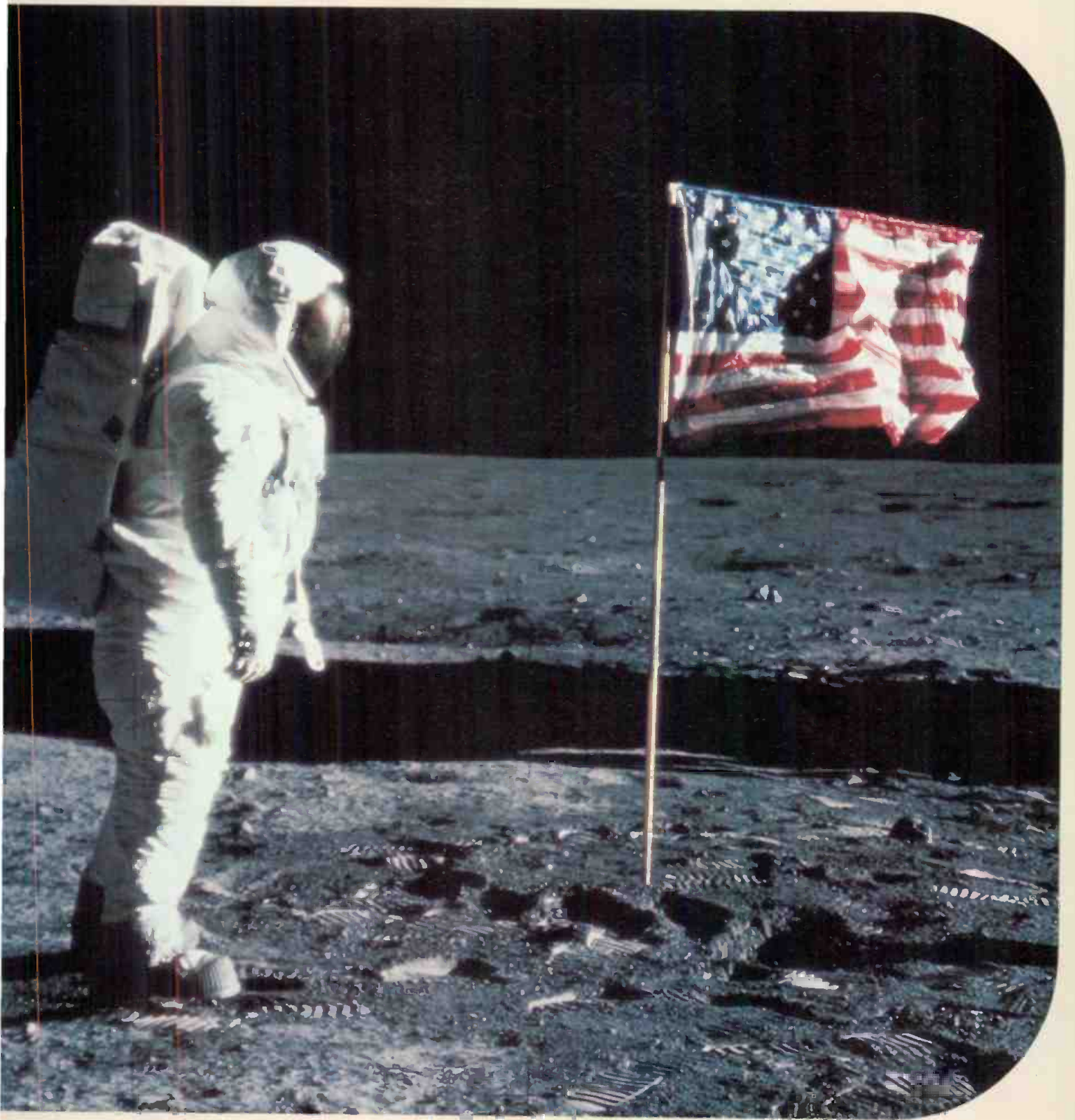

HISTORY IS RECORDED ON SCOTCH VIDEO TAPE.

3M hears you...

3M

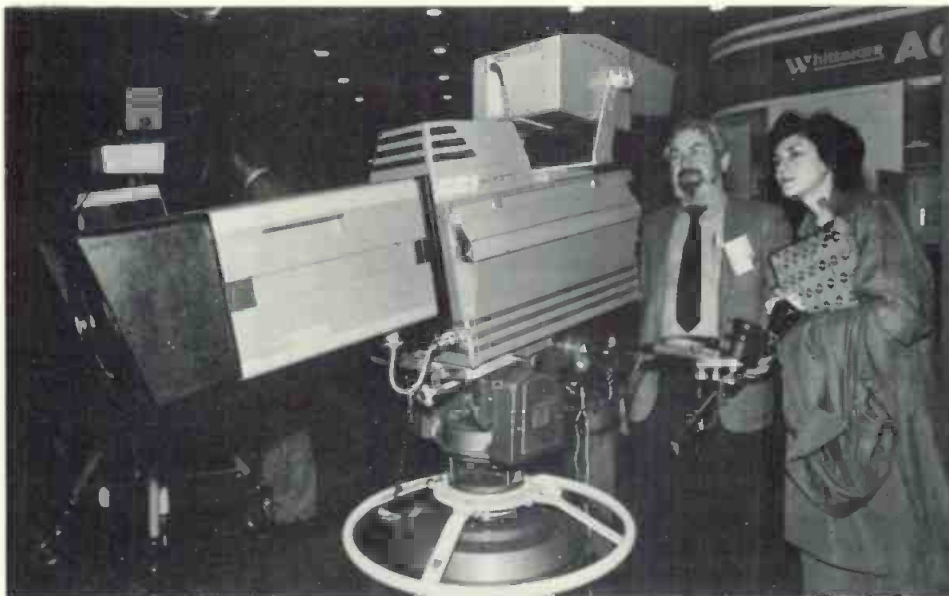

CEI's Foton-1 features heavy use of microprocessors.

ures heavily in the design of new **CEI Foton-1** which is intended to provide video operators with some of the handling features found in cinema cameras. For one thing, the microprocessor provides continuous automatic registration utilizing picture detail itself rather than a diascope. In another important innovation, the nine-inch viewfinder gives the operator a unique zoom

frame indication plus a safe picture area. Adjustment procedures required on the camera are displayed in the viewfinder.

Ikegami's electronic cinematography camera, the **EC-35**, has recently been enhanced by **Cinema Products** with a range of accessories including a follow focus mechanism, a matte box, and the popular J-4 zoom control.

The **EC-35** was also featured by **Camera Mart**, its East Coast distributor.

For more information: Philips **LDK-6**, 427; RCA **TK-47B SCRUI**, 428; Bosch Fernseh **KCI-90**, 429; CEI **Foton-1**, 430.

Lenses

Most of the new lenses at the exhibit were for studio cameras. **Canon's** pride was a new 40:1 zoom for one-inch tubes called the **Olympian**. Not only will it bring in the long shot under low light, having an aperture of $f/1.7$, but it offers a wide angle of view—50.7 degrees. MOD is 2.5 meters. Designated

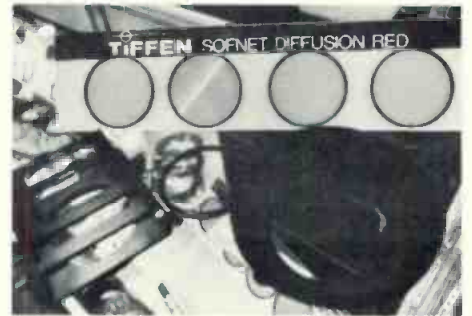

Tiffen special effects filters.

The SPECTRA SOUND Model 1500

Performance You Can't Hear

The SPECTRA SOUND Model 1500 Twenty-Seven Band Graphic Equalizer is the result of nearly two decades of engineering excellence. The Model 1500 represents a significant improvement over current equalizer technology.

The Lowest Distortion

The Model 1500 has the lowest distortion of any equalizer available. The THD and the IM distortion of the Model 1500 are below .0018%, test equipment residual, 20Hz to 20kHz, +18dBv.

The Lowest Noise

The Model 1500 is the quietest equalizer available. The signal-to-noise-ratio is 104dB below +4dBv, unweighted, 20Hz to 20 kHz.

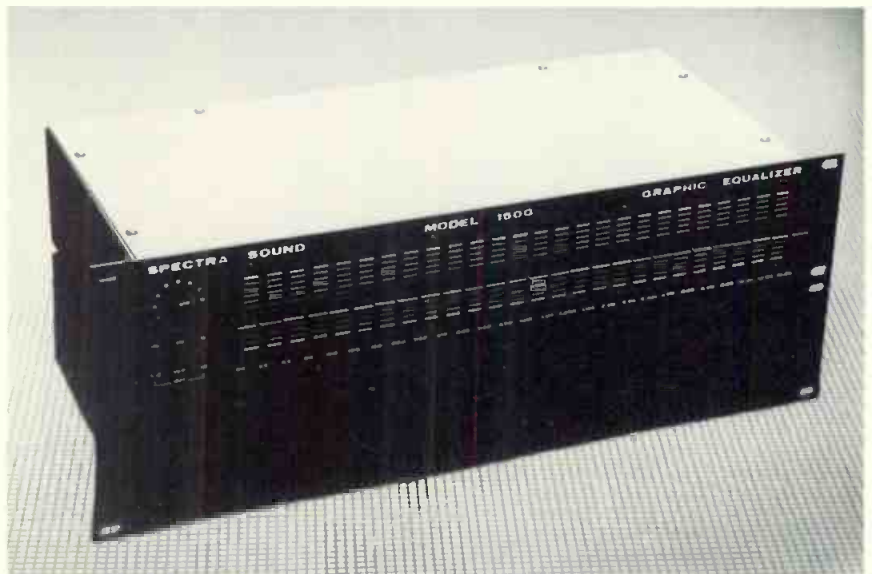

Spectra Sound 

3750 Airport Road
Ogden, Utah 84403
(801) 392-7531

Spectra Sound is a wholly owned subsidiary of Spectra Sonics

Circle 147 on Reader Service Card

the PV40X13.5 BIE, it comes with a 2X built-in extender. Canon also showed an economical ENG lens, the 15x9.5, priced at \$2100. For 2/3-inch tubes, Canon had a new 15x8.5.

Fujinon had four studio lenses—two for 1 1/4-inch tubes, the P28X15ESM and P17X16.5ESM, and two for one-inch tubes, the R28X11ESM and the R17X12ESM. These units offer a wide angle of nearly 60 degrees. In the ENG category, Fujinon had a new A14X9ERM compact unit weighing only 3.3 lbs. It also showed a handy pattern projector to hang on the end of a lens, replacing the need for a test chart.

TeleCine's lineup of new Schneider lenses include a studio type, a 15X diascope zoom for new automatic cameras, a 14X for 1/2-inch tubes, and a 14X for 2/3-inch tubes that combined wide angle with telephoto capability. The f/1.7 versatile lens can power zoom from 9 mm to 126 mm (double with a 2X extender); with the 6.3 mm—9 mm aspheric lens attachment, it can power zoom on super wide angle shots.

Angenieux's new lens was the production model of a 15x7 zoom for 1/2-inch tubes. A big attention-getter this year was an aspheric, super wide attachment that could be added to existing 2/3-inch lenses to dramatically widen shots 76 degrees—with little or no optical distortion.

Wide angle attachments were also shown by Film Video Equipment Service Corp. Wide Eye I extends the widest angle by a factor of 0.64 with little distortion. The Wide Eye II is more of a fish eye lens.

Tamron, which has been an OEM lens supplier for Sony, Hitachi, and others, came to the NAB to show its full line to broadcasters. In development are a fast lens for 1/2-inch tubes (a 6x10) and various 2/3-inch tube lens, a 14x10, 10x10, and 8x10.5.

Tiffen showed its full line of lens accessories. New this year were a soft contrast lens, a soft net diffusion attachment, and a double fog unit. Some new Spectra Tek filters for special effects were shown by Alan Gordon. As a means of reducing weight, fixed focal length Canon Telephoto lenses for ENG cameras were shown by Camera Mart and Alan Gordon. Secret for using the lightweight fixed lenses are adapters built by Optical & Textile Ltd. (UK).

For more information: Canon Olympian, 431; Fujinon studio lens, 432; Fujinon ENG lens, 433; Fujinon pattern projector, 434; TeleCine Schneider lenses, 435; Angenieux zoom for 1/2-inch aspheric lens, 436; Film Video Equipment Service Corp. Wide Eyes, 437; Tamron lenses, 438; Tiffen special effects, 439; Alan Gordon Spectra Tek filters, 440; Optical & Textile Ltd. telephoto adapters, 441.

Telecines

Perhaps the most exciting new telecine at the show was Marconi's B3410 CCD model, seen in the Marconi/A.F. Associates booth. The B3410 boasts entirely digital signal processing throughout the system, something Marconi claims as a first. Variable speed for time compression will be available as an option; other features include a pan/scan system that retains full resolution, a scene-by-scene color corrector, and a capstan-based film transport. Now in production (with a two- to three-month wait for delivery), the B3410 has a price tag of \$225,000.

Bosch Fernseh's FDL-60 CCD telecine made it to this NAB in a new "U.S. Series," the FDL 60-B2. It also featured variable locked play speed in addition to pan/scan, black stretch, forward or reverse play at five play

speeds, film timing, and an interface for computer-assisted editors.

The new Varispeed feature of Rank Cintel's Mark III C flying spot telecine allows the user to run the machine at 64 different speeds between 16 and 30 frames per second—with no loss of picture stability or quality. With the flying spot scanner, this involves changing the scan rate of the raster for each change in speed, a complex technical achievement.

Two new telecine cameras featured advanced computer control. RCA's TK-290 uses the same technology and setup terminal as the TK-47 automatic studio camera, making the two systems completely compatible. An "Autocam" option allows setup to be accomplished with a single pushbutton on the setup terminal. Registration, shading, video levels, and color balance all are adjusted automatically with the microprocessor-controlled system.

Automatic setup is also possible with Ikegami's TKC-990 telecine camera,



Telecine developments. Rank Cintel's Mark III C (above), Marconi's B3410 (below), Bosch Fernseh's FDL-60 (below right).



which incorporates a built-in diascope with all necessary setup information. Setup is also maintained automatically. The camera's master control unit will control up to 20 cameras.

Other news in telecines was a prototype **Athena 4500** 16 mm film transport from **L-W International**. This replacement for the older Athena 4000 will be available in three to six months, a spokesperson said, at a price of around \$9900. Performance has been improved with a new dc servo drive system.

New from **Nytone Manufacturing** was the **TSC-3** random access flying spot scanner system for fading between slides, which operates with the company's RA-1 or RA-2 random access controls. The TSC-3 lists for \$11,858.

Laird Telemedia had its established line of optical multiplexers and slide projectors. Featured was the **5330 optical multiplexer**, designed specifically from broadcast use.

Magnasync/Moviola's Videola V-1000, available for about a year, had a new wide-screen capability this year. It was shown interfaced with a Control Video editing system, with Videolas providing the A and B roll inputs.

BEI brought its **709 auto light control** for film chains and also showed 16 mm Fumeo professional projectors.

Multi-Track Magnetics featured its high-speed **dc servo drive kits** for film motion mechanism upgrading, along with its Model 105/DCS "Junior Desk Master" recorder/reproducer and its Video Avex MST-100 hardlock synchronizer.

Complementing telecine developments, low-light color negative films were the big news. **Fuji Photo Film**, of course, proudly described its recent Oscar award for its **A-250** ultra high-speed film, already in wide use. **Kodak** also was promoting its new high-speed color negative film, **5293**, which has recently become available, along with a new long-life color print film.

Lipsner-Smith showed a new ultrasonic film cleaning machine, the **CF-100**, a low-priced model for small operations. In the same booth was its parent company, **RTI**, featuring its TV-120 film care system and introducing the **Cinescan** fast-talking previewer.

For a discussion of telecine color correctors, see the "Digital signal processing" section.

For more information: Marconi B3410 CCD, 442; Bosch Fernseh FDL60-B2, 443; Rank Cintel Varispeed, 444; RCA TK-290, 445; Ikegami TKC-990, 446; L-W International Athena 4500, 447; Nytone Manufacturing TSC-3, 448; Laird Telemedia 5330 optical multiplexer, 449; Kodak 5293, 450; Lipsner-Smith CF-100, 451; RTI Cinescan previewer, 452.

VTRs

With the maturing of the one-inch VTR market, both Ampex and Sony appeared to be aiming for the next level of one-inch penetration with their introductions of high-quality, low-cost Type C machines. Ampex's new model, the **VPR-80**, incorporates most features of the VPR-2, including Automatic Scan Tracking, a built-in editor with trim, microprocessor communications and high-level logic circuitry, and variable play. (Missing, however, are the VPR-2's video confidence heads and ability to be battery-powered.) The VPR-80 interfaces directly to the TBC-2B time base corrector for broadcastable slow motion and still frames, as well as to the ACE editing system. The compact unit, available in a rack-mountable or tabletop model, costs \$34,900.

Sony's new **BVH-2000** is approximately one-half the size and weight of the BVH-1100, but handles full two-hour tape reels. It offers high-speed dynamic tracking, a plug-in TBC, and versatile system interface. The keyboard controller is available in three versions, with the most sophisticated capable of extensive editing in time code or control track. The tape path is a full dc servo system controlled by a Z80 microprocessor, with retractable guides and audio heads for threading and cleaning ease. Another advanced feature is motion memory, which allows the machine to store 30 seconds of tape motion for replay. Deliveries of the machine, which starts at \$39,900 for the basic model without TBC, are scheduled to start this month; a spokesperson said the BVH-2000 was already



BVH-2000 one-inch VTR from Sony.

heavily in backorder.

High-end machines are still going strong, however, especially with the introduction of the **3M/NEC TT-8000**, an update of the TT-7000 (still in active production). New options for the TT-8000 include program time expansion and compression from 0.01 percent to 9.99 percent (developed in conjunction with Lexicon), an edit interconnect for multiple VTRs, edit trim, and color playback without a TBC. An NEC spokesperson pointed out that the TT-8000 meets the new FCC Part 15 EMA spec, which will be mandatory after October 1982. The machine is also capable of split edits and audio overdub from audio one to audio two. The TT-8000 will be available in October, priced at around \$79,000; a "plain Jane" version will sell for \$45,000.

Bosch Fernseh brought two new one-inch machines, the **BCN-100 multicassette recorder** and the portable **BCN-21**. The BCN-100 features random access to 32 cassettes and a choice of three tape decks. It will



Ampex's VPR-80 has most features of the VPR-2.



3M and NEC featured the TT-8000.

the **IVC-1**. Designed for post-production applications, it combines the excellent tape transport of the IVC-9000 deck with Cezar's tri-band recording technique. Three component signals are recorded separately, with Y bandwidth at 4.2 MHz, I bandwidth at 1.5 MHz, and Q at 600 kHz, providing full NTSC bandwidth on playback. Separate recording enables post-production color correction and processing after the initial signal recording. IVC-1 is scheduled for July delivery at \$29,500. An editor, IVC-1E, will follow in the fall and be priced at \$34,500.

Two new U-Matic recorders featured some sophisticated enhancements. **Sony's BVU-820 VCR**, seen before in prototype, appeared this year in a full-fledged production model. An updated version of the BVU-800, the 820 now offers Dynamic Tracking for full-quality playback from three times normal speed forward to play speed reverse, plus full video confidence.

Video confidence heads were the featured attraction on U.S. **JVC Corp.'s** new 3/4-inch VCR, the **CR-4700U**. The new unit is SMPTE time code capable (with a time code genera-

record, edit, and play its own cassettes or others recorded in the Bosch format. A variety of applications are possible, including continuous, unbroken on-air playback and recording with no operator intervention.

The **BCN-21** reel-to-reel portable weighs 20 lbs and is half the size of Bosch's **BCN-20** portable. It accommodates reels of up to 60 minutes and features auto editing for in/out decisions, search mode for record/playback start, and an audio system with limiter and input mixing. The unit will be available for delivery early next year, the company says.

The A.F. Associates booth featured **Marconi's** latest MR2 Type C update, the **MR2B**. The new version features full electrical control of the capstan motor and auto stop in shuttle in both directions. In most other respects, it is identical to the **Ampex VPR-2**. Complete with all options (including a TBC and AST), the recorder runs \$80,000.

Hitachi's HR-200, seen at previous NAB shows, came this year in a new console configuration designated the 210. The new housing includes space for monitors and front-panel controls. The **HR-210**, with housing, slow mo, and TBC, sells for about \$65,000. Hitachi was also featuring its **HR-300** Type C machine with full three-hour recording capacity, for \$80,000.

RCA continued to showcase its **TR-800**, introduced last year. The VTR is fully microprocessor-controlled and accommodates two-hour tape reels. The company stressed the TR-800's applications as an editing recorder.

Having completed financial negotiations with IVC, **Cezar International** proudly unveiled its brand new VTR,



SOUND UNSEEN

THE BEYER MCE 5

Voice and appearance are key to a news announcer's success. Beyer benefits both with its MCE 5 electret condenser mic. A matte-black omni so tiny it's virtually invisible. Full 20-20,000Hz range projects the vital presence of the speaker, uncolored, undistorted. Unique floating element eliminates clothing noise. Removable windscreen for outdoors. 62dB S/N. 116dB overload. 700-ohm balanced output for professional performance. Phantom or self-powered, also available in a variety of connector configurations to meet every application requirement, including wireless.

Visit your local Beyer dealer today.



ACTUAL SIZE.



BEYER DYNAMIC, INC.
5-05 Burns Avenue, Hicksville,
NY 11801 • (516) 935-8000

Bob Cezar shows the IVC-1, which records R, G, and B components separately.



tor attached) and features microprocessor-based solenoid controls and video S/N of greater than 46 dB. Also from JVC was the **BR-6200U** professional VHS recorder, with record and playback capability of up to six hours, two audio tracks with Dolby noise reduction, and microprocessor-based controls.

Another professional VHS system was offered by **Panasonic**, whose **NV-8950** provides noiseless variable playback in both forward and reverse as well as a noiseless still picture, according to the company. This is achieved with four video heads.

Teac Video once again brought its **AVTR U-Matic** recorders, designed specifically for airborne applications. These units operate on standard aircraft or helicopter power and are protected from RF or telemetry interference.

TechTran International showed its **PVU-1000** portable video unit, a 1/4-inch NTSC recorder in a briefcase. Complete with a tiny built-in monitor, the system is intended primarily as a demonstration tool for business.

Merlin Engineering Works returned to the NAB with its **ME-258** ultra-wideband one-inch VTR, based on the Bosch BCN-50. The modified recorder achieves a bandwidth of 10 MHz at 48 dB S/N and can record HDTV signals. The company's **ME 238** extended-play conversion kit gives two-hour, 40-minute play time on Type C VTRs.

Delcom introduced a modification to the **Sony VO-5850D U-Matic VCR** that added several functions, such as a playback audio mixer, a dual audio tone generator, an audio countdown generator, black burst generator, and pulse cross output.

Video head refurbishing services continued to be demonstrated by such companies as **Spin Physics**, **Saki Magnetics**, **Videomagnetics**, and **Computer Magnetics Corp.** Videomagnetics has a new hardback support for quad ferrite tips; Saki's latest offering is audio posts for quad and one-inch VTRs.

For more information: Ampex VPR-80, 453; Sony BVH-2000, 454; 3M/NEC TT-8000, 455; Bosch Fernseh BCN-100 multicassette recorder, 456; Bosch Fernseh BCN-21, 457; Marconi MR213, 458; Hitachi HR-210, 459; Hitachi HR-300, 460; Cezar International IVC-1, 461; Sony BVU-820, 462; U.S. JVC Corp. CR-4700U, 463; JVC BR-6200U, 464; Panasonic NV-8950, 465; Merlin ME-258, 466; Delcom Sony modification, 467.



Record, play and dub complete sporting events and full-length movies . . . non-stop.

Record and playback up to 2 hours, 40 minutes on any standard Sony BVH 1000, 1100, and 1100A or Ampex VPR-1C, VPR-2 and VPR-2B Type C VTR with the Merlin ME 238 conversion kit.

Extended play time allows most full-length movies and sporting events to be recorded on a single 12 1/2" reel. Ideal for master playback when dubbing to small format machines as well as for cable and broadcast automated programming.

MERLIN

1880 Embarcadero, Palo Alto, CA 94303

Call Toll Free — 800-227-1980 (California — Call Collect 415-856-0900)

Merlin Engineering has a full range of products and assemblies for bringing your broadcast VTR up to date, as well as complete engineering facilities for custom applications. Write for your copy of the Merlin catalog.

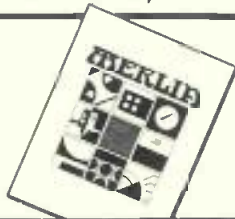

Videotape

Maxell showed the only new one-inch videotape at the show—so new that no specifications were available. The tape

Circle 149 on Reader Service Card



RTI's cleaner/evaluators.

will be sold in 30-, 60-, and 90-minute lengths beginning in August, a spokesperson said. Agfa-Gevaert had new 3/4-inch U-Matic cassettes in a variety of lengths; the company also said it planned to have new Beta and VHS cassettes by this month.

Fuji featured the H520 U-Matic cassette with its Beridox formulation. Also new was the T-160 eight-hour VHS cassette; the line of Super High Grade videocassettes made its first NAB appearance.

Panasonic had a new high-grade, high-density VHS cassette, for which the company claimed increased video S/N over conventional VHS tapes. TDK also had a new VHS tape with its Super Avilyn formulation. Another major videotape manufacturer at the show was 3M, with its Scotch line.

To help erase all that tape, Bell & Howell introduced a new automatic bulk eraser, the Datatape TD 500, which erases all commonly used audio and video tapes. Garner brought its videotape degausser, now in a new model designated 1100A with increased erasing capacity.

Recortec unveiled a new one-inch videotape evaluator, the VTE-101, that accommodates reels up to 10 1/2 inches and prints out the location of all defects. Elcon, too, had a new one-inch cleaner/evaluator, the 254, shown in prototype with deliveries expected for the end of this year.

RTI introduced three new evaluator/cleaners for 3/4-inch, Beta, and VHS videocassettes. All feature optional erase capability. Quanta Corp. showed the DOM 4 evaluator, which has been marketed by Studio Film & Tape. Quanta is now directly marketing versions of the tape evaluator for 1/2- and 3/4-inch cassettes.

Audico, Inc., demonstrated its videotape loading systems. The company's Model 751 now is capable of transferring tape from one videocassette directly to another, the company's answer to the bulk tape shortage.

Bell & Howell Datatape TD 500, 474; Garner 1100A, 475; Recortex VTE-101, 476; Elcon 254, 477; RTI evaluator/cleaners, 478; Quanta tape evaluator, 479; Audico tape loader, 480.

Slow motion recorders

A couple of new entries highlighted the slow motion recorder area this year. Echo Science introduced the Frame Bank, an updated version of the EFS-1A Discassette recorder. The new model features a streamlined design for

fewer mechanical problems, greater reliability, and ease of service. In other respects, the Frame Bank is similar to its predecessor, with recording of full video frames, direct NTSC recording, broadcast playback through a TBC, and nonbroadcast playback with a built-in processing board. The system is deliverable in 60 days and costs \$22,500. Echo continued to stress its Image Maker, introduced last year, which stores stills on a Discassette and manipulates them for special effects.

Eigen Video returned with its magnetic disc recorder, seen at earlier



Broadcast Microwave Services, Inc.

OLD HANDS AT PORTABLE SPORTS AND NEWS MICROWAVE

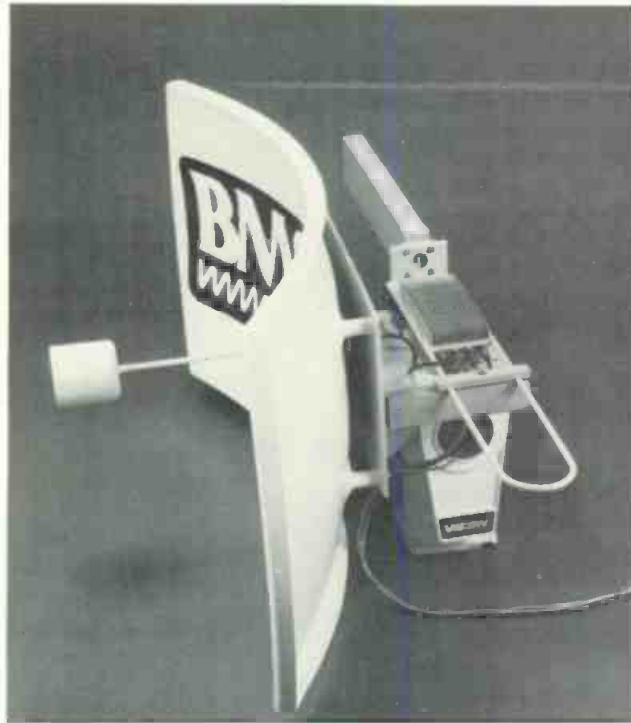

Truck Mounted Microwave
Frequency agile, power programmable
New Microwave System with removable
portable microwave transmitter.
2 or 12 watts.



Portable News Microwave
for use in news cars.



19 db 2 Foot Dish Antenna.
Available in 2, 7 or 13 Ghz.

Some of the stations
using BMS portable
microwave systems.

KHJ KOMO KFMB KTVI WTVC WISN
KABC KATV KPNX WSPA WNAC WXYZ
KCST KGTV KOOL WTSP WFAA WFSB

7320 Convoy Court San Diego, CA 92111 (714) 560-8601

Circle 150 on Reader Service Card

BWE JUNE, 1982 83

For more information: Maxell one-inch videotape, 468; Agfa-Gevaert 3/4-inch U-Matic cassettes, 469; Fuji U-Matic cassettes, 470; Fuji T-160 VHS cassettes, 471; Panasonic VHS, 472; TDK VHS, 473;

shows, and several new products. The new offerings included a mono 10 MHz disc recorder, a disc frame recorder that records one frame per revolution (up to 250 still images on a single disc), and the DSR 4 digital frame-store, which has three record modes and records information as separate and distinct fields or as frames. Options for the DSR 4 include noise reduction.

Colorado Video was back describing its slow-scan video transmission system, used by North American Newstime (started by UPI and Colorado Video as United Press Newstime) for a 24-hour news and feature service that reaches 900,000 homes, according to the company.

As in past years, all the one-inch VTR manufacturers had slow motion controllers for their machines. One new entry was Sony's DTR-2000 dynamic motion controller for the BVH-2000 and BVU-820 recorders. The DTR-2000 varies playback speed from -1 to +3 times normal play and features a stunt learn mode that remembers 30 seconds of tape motion with a single command.

RCA demonstrated the Multi-Rate Video Controller (MRVC) accessory for the TR-800, a desktop unit that adds "instant replay" capability without the



Disc recorder from Eigen Video.

need for a separate slow mo machine. Other companies showing slow motion controllers included Ampex and Hitachi.

Visitors to previous NAB shows had already seen the animation systems on view this year. Lyon Lamb had a new accessory to its VAS IV broadcast animation system, however—the GMC series four-axis or eight-axis computer motion control system for an animation stand, moving it north-south and east-west, rotating it 360 degrees, and moving the vertical column up and down, all either frame-by-frame or in real time.

Animation Video was back with its AniVid System, introduced last year. AniVid consists of a microprocessor-based VTR controller that interfaces to an unmodified, customer-supplied VTR.

(For a discussion of digital still stores, see the section on "Digital effects.")

For more information: Echo Science Frame Bank, 481; Eigen Video 10 MHz disc recorder, 482; Eigen disc frame recorder, 483; Eigen DSR 4, 484; Sony DTR-2000, 485; RCA Multi-Rate Video Controller, 486; Lyon Lamb GMC series, 487; Animation Video AniVid System, 488.

Digital art and graphics

As has become customary at NABs for the past several years, digital art and graphics systems continued to draw big crowds (though not perhaps all of them buyers). Also as customary, MCI/Quantel again introduced what will become the cutting edge of this technology, repeating past performances with the DPE-5000+ and the Digital Paint Box.

This year's entry, demonstrated as a pre-production prototype in a hospitality suite, was Mirage, Quantel's answer to the popular Ampex Digital Opticals (ADO) system which introduced the industry to three-dimensional effects last year. But Mirage goes it at least one step better. Working with graphics primitives such as cubes, cylinders,

Eventide's BD955 Broadcast Audio Delay Finally Has Some Serious Low-Priced Competition...



EVENTIDE'S BD931 (MONO) PRICED AS LOW AS \$1795

EVENTIDE'S BD932 (STEREO) PRICED AS LOW AS \$2595

Now there's a worthy low-cost alternative to Eventide's BD955 – the world's best-selling digital obscenity delay. Eventide's new BD931/932 series is priced to be cost-effective even for stations that air only limited talk programming. Available in mono or stereo, with 3.2 or 6.4 seconds of delay, these new units feature specs that far exceed the performance of other economy delays:

FREQUENCY RESPONSE: 40Hz to 16kHz ± 1dB.
DYNAMIC RANGE: Greater than 90dB.
DISTORTION: Less than 0.2% at 1kHz & 100Hz.

So now stations on a tight budget can say goodbye to the problems of trouble-prone tape loop delays without sacrificing audio quality. Eventide's BD931/BD932 series is the low-cost, high quality alternative.



OUR BD955 SERIES – NOW A GREATER VALUE THAN EVER.

For the ultimate in operating convenience, Eventide's BD955 is still in a class by itself. Only the BD955 has the patented AUTO CATCH-UP feature that automatically rebuilds the delay after objectionable material is dumped. There's no need to fill the delay period. Now increased production and lower memory chip prices have enabled us to substantially reduce prices on all BD955 models – you save up to \$2400!

Eventide
the next step

265 West 54th Street
New York, N.Y. 10019
(212) 581-9290

Circle 151 on Reader Service Card

spheres, and so forth, preprogrammed into the computer's database, the artist can custom-create special effects using a control panel borrowed from the DPE. Page flips (with a transparency setting that allows both partial see-through and also "back of the page" flips); cylinders and spheres that rotate at any speed in three dimensional space; the ability to map a digitized camera input onto any of the shapes so that the image is carried along with the rotating geometric object; tumbles, flips, and so forth along any axis; and "motion blur" to simulate friction drag are some of Mirage's many illusions. The price tag of \$300,000 for a basic system is the sobering reality.

The digital art/paint systems which began to become popular two years ago were in evidence everywhere throughout the show, though the Ampex AVA, grandfather of these systems, is no longer being actively marketed.

A contender to replace it is the Quantel "Paint Box," now in its final product form with deliveries scheduled to start this summer priced at under \$150,000. Several improvements have been made in the system since it was shown in prototype last year. Features such as "cut and paste," a full-function character generator, pseudo animation



The Aurora/100 Videographics system boasted new features.

program, and so forth are now integrated with the diverse painting and drawing style modes of the original system. The unique pressure-sensitive stylus is still a strong selling point.

Another high-powered system is Images from the Computer Graphics Lab of N.Y.I.T. In addition to all the customary painting and graphics

modes, the Z-buffer framestore permits painting with three-dimensional brushes and the Lab may soon introduce three-dimensional modeling programs to the basic software. Animation effects are achieved with one of the most well-developed color map cycling programs available.

New features have also been added

RADIO/TV STAR!

Cetec's new 8000 Series console was designed and built especially for broadcasters. You get all the features you need without paying for things you don't use. This means you get a luxury console — including precision Penney and Giles faders — at a moderate price. Features include five

lighted meters, two peak indicators, five advisory enuciators, and a built-in LCD timer. In addition to the 25-watt RMS monitor amp, there is a separate headphone amp with enough gain to keep

everyone happy. Just pull the monitor control knob and you get instant mono sum for quick A/B comparison. You can even

feed all three stereo busses and the mono

buss at the same time without interaction. Great specs include low distortion and noise, with plenty of head-room.

Strong RF fields do not affect the 8000. Broadcasters helped us design the 8000, and the results are just outstanding.

Isn't it time you talked to Cetec?



For the first time, dealer inquiries are invited.





Thomson-CSF's Vidifont Graphics V.

to the **Aurora/100 Videographics** system, making it even more suitable for station applications (it already has the ability to handle four user stations with no additional modifications). New features include a weather package for formatting National Weather Service maps and a new animation capability to supplement the extensive pseudo animation programs already present. Using a Lyon Lamb controller whose modes are present as menu choices on the Aurora workstation menu, the artist draws a frame and then records it on tape; the playback sequence at 30 fps is true video animation. Aurora also had an electrifying halo ripple effect and more color availabilities.

A somewhat similar approach was taken by **Animation Video** whose AniVid controller was demonstrated in a hospitality suite interfaced with a new digital art system from **On-Line Computer**. The graphics system, originally developed for business graphics, uses a 512 x 512 pixel framebuffer configured in layers—either four full-color or eight two-color pages (with up to eight colors displayable on the full-color displays). Each layer is created separately, then woven together with other layers or left separate so that individual, multi-plane pseudo animation effects can be created. For true animation, individual drawings are recorded on a VTR through the AniVid controller.

Another spillover from the computer graphics arena, **Via Video** showed an updated version of its system, introduced at SMPTE, in a hospitality suite. **System One** takes the same multiplane approach, allowing animation effects on four separate pages (in cycles up to 128 frames per page). A full painting and drawing program is available, the whole system costing as little as \$35,000. Also available is a high resolution option, priced at \$7000, raising the pixel structure to 756 x 484 with 16 colors displayable per page out of a total menu of 4000.

Systems like those from Via and On-

Line, originally developed for other applications, require an NTSC encoder—devices becoming quite plentiful. Lenco showed several models as did Via and Corporate Communications. The handy **VB-3 micro-keyer** from **Video Associates Labs**, at \$2400, even allows an Apple II graphics program to be integrated with NTSC video. The plug-in card for the Apple includes sync generator and proc amp as well as many keying options both full and part screen.

A major product trend in computer graphics is for character generator manufacturers to offer painting programs as part of the software for font composition, especially since the relatively inexpensive addition of the required framestore yields dramatic image results. **Thomson-CSF** led the way last year with the **Vidifont Graphics V**, which was again highlighted with several new software features. **Dubner**, too, has increased the capabilities of its **Color Background Generator (CBG)** system; either a keyboard or the familiar magnetically encoded drawing tablet is used to access multiple memory planes which can also be woven together to form graphics images.

New in this arena is **Chyron**, which has expanded its **camera font compose** program to now incorporate freehand **drawing and painting** through a magnetic stylus. 512 color choices are available, with up to 16 displayable per image. Brush sizes include six sizes of rectangular brush. Other features include an area filling program, magnification for detail correction to six times, and a multi-plane memory (up to four pages), though the software for the latter is not quite developed yet.

Bosch Fernseh also introduced a new graphics module for use with two-channel versions of its **Compositor I** character generator. The digitizer tablet-based module offers a choice of 256 colors and has a 640 x 480 pixel resolution. Parts of the system will be familiar to those with the **Compositor** font compose program.

Virtually every manufacturer with a digitizing tablet-based font compose system is now offering painting programs, including **Quanta Corp.** (the erstwhile System Concepts) which introduced its new **Q-8** character generator with font compose at the show. The painting system is still under development but promises extremely high resolution.

3M's approach with the **D-8800** is to use its font compose tablet in connection with a supplemental mainframe computer in order to achieve complex background graphics.

Systems for weather forecasting and display are also proving a fertile breeding ground for digital art systems—either linked with National Weather Service and satellite maps or else as standalone units. The **McInnis-Skinner Weathergraphics** package is proving popular in this area, permitting freehand drawing in conjunction with weather maps and also for background art. **Spectra Computer**, an outgrowth of the Weathercaster system, offers the **S-1010 Fine Arts Computer**, a standalone system which can be completely separated from its weather map origins. **Weathermation**, another company in the field, seems undecided about whether to offer its high-resolution color radar map display unit, which incorporates weather symbols and graphics, as a standalone unit. Making strides is **Colorgraphics**, whose 760 x 484 pixel resolution system has four memory planes and offers a choice of 4096 colors. In addition to graphics primitives, memory capacity includes 100 pages in internal RAM. System price is just under \$40,000.

Arvin Diamond showed its new **Sat-Weather 3** system that provides direct conversion of weather data, including satellite-produced infrared photographs, into colorized video. **Sat-Weather** generates an outline map of the country or state and also colorizes the image in "natural" shades of white, brown, green, and so forth corresponding to geological features.

Also showing new additions to its



Chyron font compose/graphics module.

40 to 1

Canon PV40 x 13.5B IE: THE OLYMPIAN

Canon moves you a giant step forward with a 40X broadcast quality zoom lens. An incredible new lens that allows you to cover a stadium at wide angle or fill the frame with the quarterback's eyes.



controlled cameras.

We call it The Olympian. Not only because it is ideally suited for sports coverage but also because of the dedication and team effort required of our optical and electronic engineers in making this lens a reality.

Never before has a single lens provided this much flexibility and sensitivity, with remarkably little change in effective aperture throughout its entire 13.5mm-540mm* range. Built-in extenders let you go all the way to 1080mm and each lens is diascoped-equipped for modern microprocessor-

Enlarge a dollar bill forty times and it covers an area twenty feet long and eight feet wide. Now think about what you could do with the Canon PV 40 x 13.5B IE!

*1" cameras. Also available in 30mm plumbicon.



Canon®

Optics Division

Canon USA, Inc., Head Office: One Canon Plaza, Lake Success, N.Y. 11042 (516) 488-6700

Dallas Office: 11311 Stemmens Freeway, Suite 1, Dallas, Texas 75229 (214) 620-2641 Chicago Office: 140 Industrial Drive, Elmhurst, Ill. 60126 (312) 833-3070

West Coast Office: 123 Paularino Avenue East, Costa Mesa, Ca. 92626 (714) 979-6000

Canon Canada, Inc., 3245 American Drive, Mississauga, Ontario L4V1B8, Canada (416) 678-2730

© 1982 Canon U.S.A., Inc.

Circle 153 on Reader Service Card

www.americanradiohistory.com

**NEVER BEFORE HAS
THIS VITAL
COMPONENT BEEN SO
SUCCESSFULLY
INTEGRATED INTO A
1" VIDEO RECORDER.**

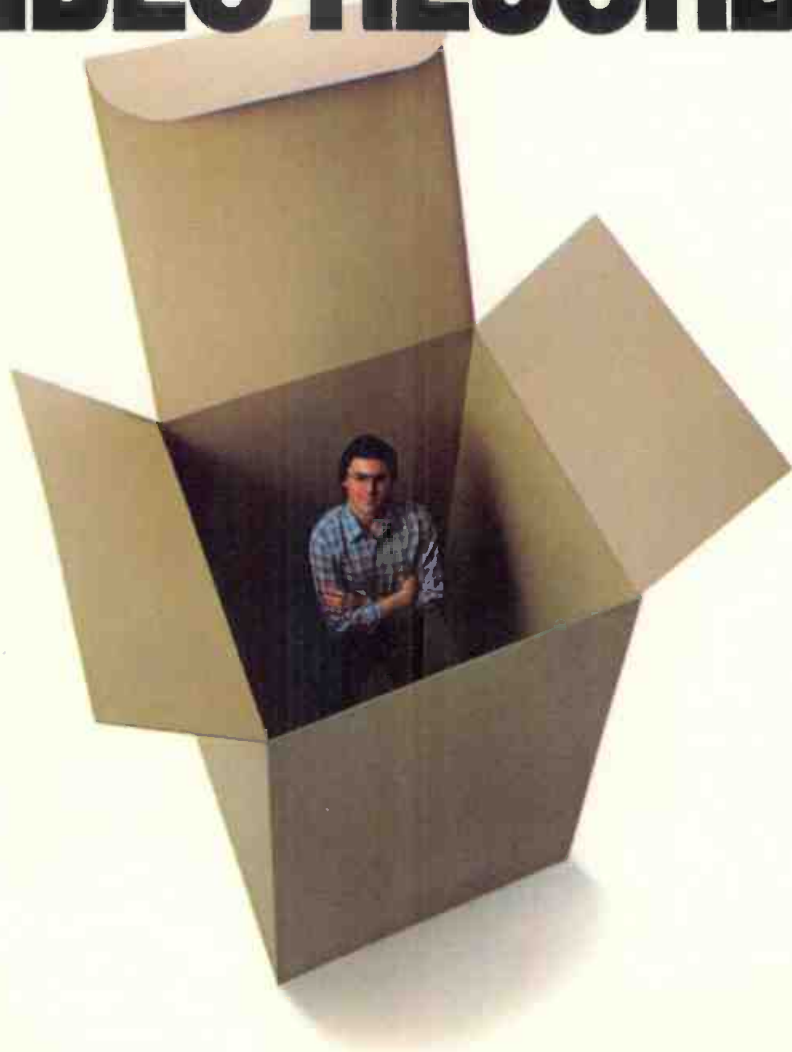

SONY INTRODUCES A 1" VIDEO RECORDER TAILORED TO THE PEOPLE WHO USE IT: THE BVH-2000.

Because Sony probably has more experience selling and servicing 1" VTR's than anyone else, we're in an unequaled position to understand the wishes of 1" video users.

And now, Sony announces with fulfillment for the broadcast industry: the new BVH-2000 1" video recorder.

WHY "BVH-2000" WILL MEAN DIFFERENT THINGS TO DIFFERENT PEOPLE.

In broadcast recording, there is no such thing as one typical situation.

That's why there's no one single BVH-2000.

The BVH-2000 actually allows you to "design" the VTR you need for your own particular applications and budget.

You can choose among three different control panels—ranging from a basic model to one with virtually every possible feature and function.

And the tape transport system, signal system, and control section can either be combined into a single unit, or separated easily and installed in a 19" rack or console.

The BVH-2000 also gives you far greater latitude in setting up your entire recording system. Various remote-control connectors enable you to interface your system in a variety of ways for studio, mobile, and editing configurations. Direct interface with U-matic[®] and Betacam[™] is possible, too. The BVH-2000

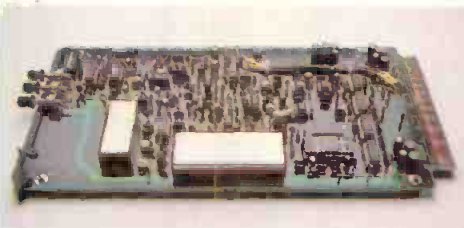

Plug-in time base corrector (optional).

also has an optional plug-in time base corrector.

What's more, the BVH-2000's lighter weight and smaller size (almost 50% less than its predecessor) make it as ideal on the road as it is in the studio.

And because of the ever-increasing number of applications requiring longer program times, the BVH-2000 provides up to 2 hours of tape time.

A VTR THAT LEADS THE SIMPLE LIFE.

In the BVH-2000, unlike most other VTR's, microprocessors are used to their full advantage. All data necessary for servo control are channeled into a central processing unit, making the operator's control over all systems and functions simpler and more precise.

Life is made simpler yet by the fact that every necessary function control, metering facility, and electronic module is accessible from the front.

Even the way the tape moves through the recorder has been simplified. One innovation—an extremely precise servo mechanism



The BVH-2000 (shown with Type-III control panel).

—permits the entrance and exit guide posts to move about 10mm away from the drum during threading. The result is the easiest threading system ever in a 1" video recorder.

THE MOST ARTICULATE VTR EVER BUILT.

The BVH-2000 removes much of the mystery from maintenance, too. It literally tells you about malfunctions—usually well before you'd notice them yourself—through a microprocessor-governed self-diagnostic system.

The system includes various alarm functions and numerous checks to confirm that everything is working properly. Most defects can be easily found—allowing for far less complicated maintenance and repairs, and reducing downtime considerably.

And because the best way to simplify maintenance

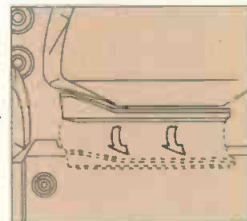
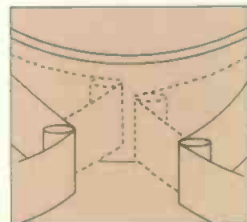

To simplify threading, guide posts automatically move away from drum, and audio head cover opens.

is by lessening the need for it, the Sony BVH-2000 has been designed to be virtually maintenance-free down to the last detail. For example, only brushless DC motors are used, and all incandescent lamps have been replaced with high-brightness LED's.

Other welcome advances include a greatly expanded dynamic tracking range (from reverse at normal speed to forward at 3 times normal); programmed play (allowing you to vary playback speed across a range of $\pm 20\%$ of normal speed); and video and audio confidence.

Remarkably, these are only some of the Sony BVH-2000's innovations. All of them add up to form the answer to virtually every need ever expressed by the users of 1" video.



Display board for self-diagnostics and other data-processing functions.

To find out how it can answer yours, write Sony Broadcast, 9 West 57th St., New York, NY 10019. Or call us in New York/New Jersey at (201) 368-5085; in Chicago at (312) 860-7800; in Los Angeles at (213) 537-4300; in Atlanta at (404) 451-7671; or in Dallas at (214) 659-3600.



Front access to all electronic circuits and modules.

SONY
Broadcast

Sony and U-matic are registered trademarks and Betacam is a trademark of Sony Corp. © 1982 Sony Corp. of America, 9 W. 57th St., New York, N.Y. 10019.



"Chalk Board" Telestrator from Interand.

graphics systems line was **Interand** which brought a low-cost, monochrome "Chalk Board" version of its **Telestrator**. The artist or commentator draws directly on the video screen using an interactive stylus that can be brush, rubber stamper, symbol mover, and so forth. On both the new system and an updated version of the full Telestrator program, controls have been incorporated into a display on the design station that eliminates knobs and dials.

The extremely low-cost **Video Free-**

Hand Writer was shown by **For-A**, also permitting limited-function drawing directly on the screen.

Grove Video introduced a brand new **digital graphics system** designed to allow limited-contrast digitizing of camera or tape inputs and then animation in 40-frame loops. Other software permits scaling, positioning, and dissolving the various digitized images.

Finally, though not a digital product, the **Frank Woolley real time animation system** should be mentioned. By using cutout pieces of polarized light-

sensitive material (similar to the blinking eye effect of prizes in Cracker-Jack boxes), the station artist can create amazingly diverse graphics that appear to move.

For more information: MCI/Quantel *Mirage*, 489; Quantel "*Paint Box*," 490; Computer Graphics Lab *Images*, 491; Aurora *Videographics system*, 492; Animation Video *On-Line Computer*, 493; Via Video *System One*, 494; Video Associates Labs *VB-3 micro-keyer*, 495; Thomson-CSF *Vidifont Graphics V*, 496; Dubner *CBG system*, 497; Chyron *font compose/painting*, 498; Bosch Fernseh *Compositor I painting*, 499; Quanta Corp. *Q-8 500*; 3M *D-8800*, 501; McInnis-Skinner *Weathergraphics*, 502; Spectra Computer *S-1010 Fine Arts Computer*, 503; *Weathermation*, 504; *Colorgraphics*, 505; Arvin Diamond *Sat-Weather 3*, 506; Interand *Telestrator*, 507; For-A *Video Free-Hand Writer*, 508; Grove Video *digital graphics system*, 509; Frank Woolley *animation*, 510.

Character generators

Many of the advances seen in character generators at NAB were software modifications in font compose programs leading to extended graphics capability. This was true of all the larger, well-established systems such as the Thomson-CSF Vidifont, Bosch Fernseh Compositor, Chyron IV, and 3M D-8800.

NEW One Inch Video Tape Evaluator



- Full Cycle Clean & Evaluate 2.7 minutes
- Fast Clean & Rewind Cycle 1.8 minutes
- Ruggedized for 24 Hour Operation
- Proven Safety and Reliability for Tapes

Recortec installed its first Video Tape Evaluator (VTE) over 12 years ago! Now, we have combined all our industry experience and customer feedback into a new design with all the desirable features at an unbeatable price.

The new VTE-101 provides a built-in diagnostic panel for ease of calibration and a microprocessor controlled printer to provide more meaningful outputs. Our VTE's have been known to pay for themselves faster than originally estimated. Why not order yours now? Satisfaction guaranteed! To find out more, call Sid McCollum, our National Sales Manager.

RECORTEC

475 Ellis Street Mtn. View, CA 94043
Tel (415) 962-0220 TWX 910 339 5022

Circle 155 on Reader Service Card

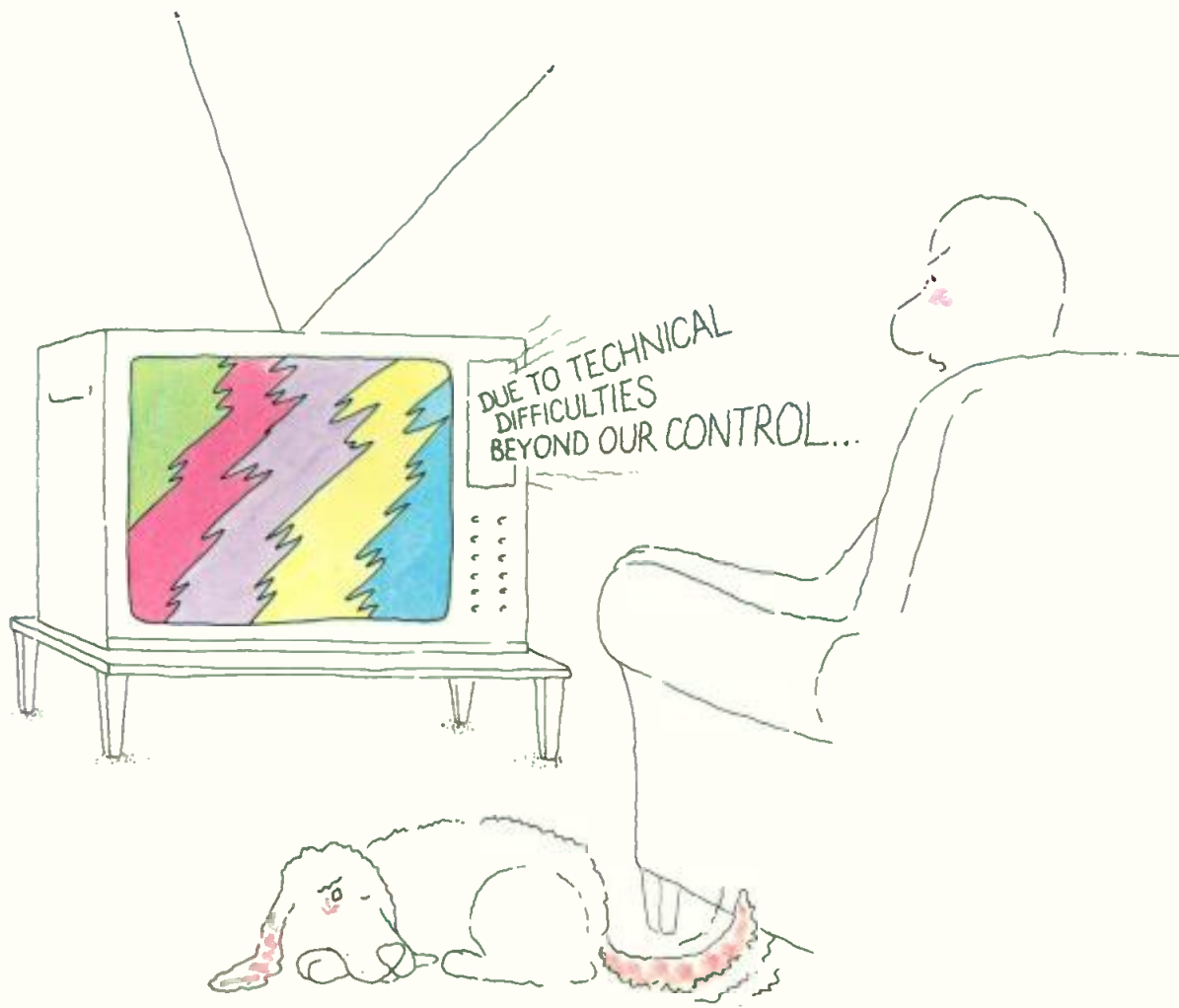

(Translation: The cassette broke.)
 (Solution: Maxell U-Matic cassettes.)

If jammed U-Matics ever make you yearn for the days of live television something is wrong with the brand of U-Matics you're using. A lot of things are very right with Maxell U-Matic cassettes.

They're built to stand up to the toughest handling and editing conditions you can dish out. The unique Maxell Epitaxial™ tape formulation gives you an extremely dense magnetic coating that yields superior chroma and luminance. The proprietary Maxell binder system makes

sure the formulation, and everything you record on it, stays up to your standards, indefinitely.

That's why every one of the networks, hundreds of independent television stations and just about every major producer, director and cameraman in the business who tries Maxell U-Matic cassettes, buys Maxell.

Your Maxell supplier can make sure your programming isn't interrupted. Ask him for Maxell U-Matic cassettes. Or ask us for more information.



maxell®

PROFESSIONAL/ INDUSTRIAL DIVISION

Our success is magnetic.

Maxell Corporation of America, 60 Oxford Dr., Moonachie, N.J. 07074 (201) 440-8020

Circle 162 on Reader Service Card



Dubner's Color Background Generator.

There were, however, some new hardware developments in intermediate and low-priced systems. One of the most significant appearances was the **Quanta Q-8**, originally promised last year. The software-based, font-loadable system features 28 nanosecond resolution and holds 12 resident fonts (three faces in four sizes each). Incremental instant italicizing, eight colors available word by word, background color line by line, and bold and fine edging are additional features in the \$28,000 package. A second channel brings the system to \$39,000.

At \$2995 **Quanta** also featured its

Microgen system with two character sizes, roll and crawl, 16-page internal memory, and automatic lower third formatting. An additional \$550 adds a nine-color character or background colorizer. Another \$1395 adds a full function second channel.

New from **Laird Telemedia** was the **Model 7200 "Communicator"**, priced at \$29,000 including dual floppy disk memory, background and character colorizing, drop shadow, and character edging. The unit holds four fonts at once; 14 fonts are currently available with a full library of 20-30 promised by July.

In the same general price area is **BEI's Marquee 2000**, a software-based character generator with advanced options such as multiple keyboards, a font compose unit, and full second channel for effects or preview. Character resolution is quoted at 31.25 nanoseconds.

From **Shintron** there was the new **Model 515D** graphics titler, a micro-processor-based system with a claimed

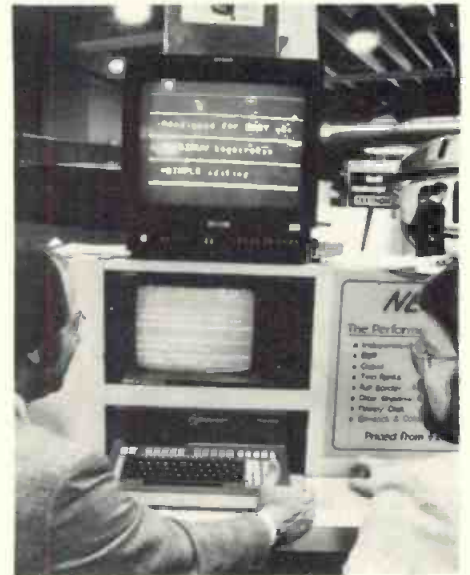

Performer 1000B from Video Data Systems.

sachtler video 25

the state-of-the-art
video fluid head
designed to supporting your
ENG- and EFP-cameras

Now ready to go into operation.

sachtler video 25

featuring:

- Center of Gravity Compensation
- 4 step Dynamic Counterbalancing Control
- 2 times 7-step on/off drag control for pan and tilt
- Touch & Go wedge plate

The rock-steady, silky-smooth cameramen's fluid head, doing everything in news gathering and field-production.

The all-in-one-piece camera support system.

Call or write:

Sachtler Corporation of America

400 Oser Ave., Hauppauge NY 11788

Phone: (516) 231 0033

a subsidiary of

Sachtler gmbh, Dieselstraße 16, D-8046 Garching

Phone: (089) 3204041, Telex: 5215340

or your nearest sachtler-distributor.

AMPEX - BOSCH -
HITACHI - IKEGAMI
- IVC - JVC - LINK -
MARCONI - NEC - PANASONICS -
PHILIPS - RCA - SHARP - SONY -
THOMSON - TOSHIBA
...and other fine makes
of professional cameras.





Panasonic adds a new perspective to prism optics performance. Introducing the WV-777.

You expect great performance from a three-tube prism optics camera and that's just what you get with the Panasonic WV-777. But Panasonic knows it takes more than a great picture to make a great camera.

Take the WV-777's sleek, low-profile design and unique side-mounted hand grip. They give the cameraman a clear, unobstructed view that makes staying with the action easy.

The WV-777 is also easy to set up and operate because all critical controls are behind an easy-open side panel. You'll find hori-

zontal and vertical linearity, skew, centering, red and blue registration and more. For added precision, there are digital auto white and black circuits with memory.

The 1.5" di-optic electronic viewfinder is not only fully adjustable, it also includes indicators for battery warning, VTR tally and other key operating conditions.

With its magnesium die-cast chassis, the WV-777 combines light weight with strength to ensure a high level of performance over a long period of time. Its three Saticon® pickup tubes and middle index prism

produce 550 lines horizontal resolution and a S/N ratio of 55 dB at recommended illumination. And for easy serviceability, the WV-777 has modular plug-in fiberglass circuit boards.

The WV-777 has a -72dB mic input, a -20dB line input, 2 audio output levels, a snap-on AC adapter and battery case. And for studio use, there's also an optional 5" (meas diag) studio viewfinder, studio lens package and remote control unit.

But perhaps the Panasonic WV-777's most surprising element is its price, \$7,650*! So broaden your perspec-

tive and get the prism optics camera designed with the cameraman in mind. The Panasonic WV-777.

*Manufacturer's suggested price.

Panasonic
VIDEO SYSTEMS DIVISION

For additional information on the new WV-777 mail to:

Panasonic Industrial Company
Video Systems Division
One Panasonic Way
Secaucus, N.J. 07094

Name _____

Title _____ (Please Print)

Company _____

Address _____

City _____

State _____ Zip _____

Phone (_____) _____

BME-682

Circle 158 on Reader Service Card

www.americanradiohistory.com

Playing Video Feed Roulette?



**YOUR NUMBER Comes Up
Every Time With QSI**

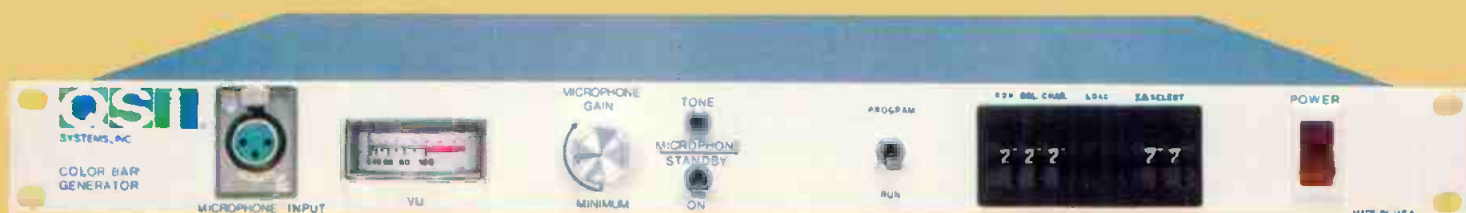

SOURCE IDENTIFIED COLOR BAR GENERATOR CB-9105

- SMPTE Colorbars
- 19" × 1 3/4" Rack Mounted
- Genlock (Sync and Sub Carrier)
- 1000 Hz Tone
- Microphone Preamp
- Video and Audio Bypass
- 8 Character ID in Front Panel Programmed Memory for up to 80 Instantly Recalled ID's

12 Linscott Road, Woburn, Massachusetts 01888
(617) 938-1403



systems, inc.

Circle 159 on Reader Service Card





Laird Telemedia's Communicator.

character resolution of only 20 nano-seconds. The system has two fonts with eight character sizes per font and features 320 lines of internal memory, character and background colorizing by row, underlining, and drop shadow—all in eight choices of color.

Also at the Shintron booth, Norwegian company **Tora Seem** unveiled its **Digitext 8000** subtitling system for American broadcasters. Cuing of multifont captions is by time code addressing.

In the \$3000 range is the new **Performer 1000B** from **Video Data Systems**. Featured are fully independent edit display, variable length and speed rolls and crawls, two resident fonts, and choice of two background colors. An add-on floppy disk memory option raises the price to \$4995.

For-A is now offering a complete line of Video Typewriters, including the **VTW-600** with automatic centering, word editing capabilities, and full editing and bordering. Options include font compose and floppy disk memory.

Knox demonstrated the **Color Box** character and background generator shown in prototype two years ago and now promised for summer delivery. Interfaced with the **K-128** character generator, it provides background color selection a page at a time in addition to top, center, bottom, and right margin drop shadow character edging. The **K-128** also features a two-station remote control system and optional floppy disks to store 400 pages each.

Comprehensive Video's new **Video Scribe**, priced at \$795, is probably the lowest cost system on the market. Capabilities include two character sizes and eight character colors.

Not to be forgotten in a discussion of character generator developments is the continuing effort being made to develop teletext standards for the U.S. now that the FCC has declined to act. Interest was intense at both the **Antiope** booth, where both the standard and high-resolution systems were shown,

and at a special exhibit of **British teletext** equipment. To test the market, **BEI** showed its **Model TCG** teletext character generator, designed to compose, edit, and display pages of teletext. The unit does double service as a studio character generator, and has multiple remote control functions with both serial and parallel data interfaces.

For more information: Quanta Q-8, 511; Quanta Microgen, 512; Laird Telemedia Model 7200 "Communicator", 513; BEI Marquee 2000, 514; Shintron Model 515D, 515; Tora Seem Digitext 8000, 516; Video Data Systems Performer 1000B, 517; For-A VTW-600, 518; Knox Color Box, 519; Comprehensive Video Video Scribe, 520; Antiope teletext, 521; British teletext, 522; BEI Model TCG teletext character generator, 523.

Production switchers

All types of production equipment are benefitting from advances in micro-processors, so that even relatively low-cost production switchers can now incorporate digital control and memory.

One of the companies leading the field in new switcher developments is **Central Dynamics Corp.** which has gathered the broad range of CDL and ADC switchers under a single umbrella and has started adding the results of some active R&D. Shown for the first time was a new, compact and economical version of the **CD-480** switcher, **Model 6S**. The switcher incorporates a powerful SFX mix/effects amplifier and a Program Processor Module to permit changing foreground and title key independently or simultaneously. Options include the CAP automation programmer, chroma keyers, single-bus quad split, and digital effects/editing system interfaces.

New from **American Data** was the **3101-20** 20-input switcher, making this series of compact switchers very broad.



Central Dynamics' CD-480 Model 4.

It features master fade-to-black and an M/E amplifier that can perform tasks requiring two conventional M/E systems.

Other new products from **CDC** included a new **downstream keyer** from **ADC**, a new **3104A "A"** version of the 3104 series from **ADC** (software-based so it can be field expanded with plug-in modules), and a fully operational **CD-480-4** switcher with **CAP** interface and interconnect with an editing system.

Production switcher giant **Grass Valley** had several new products on hand, including the two M/E version of its **300 Series** switcher, designed primarily for small broadcasters and post-production applications. Common to all switchers in the line is a new "master" **E-MEM** system capable of controlling all E M/Es with a single automation controller, and dissolve and other transitions from one **E-MEM** memory to another.

Grass Valley also showed a new version of its popular **1600 Series**, the **1680**. While maintaining the exact



Vital's Saturn Series switcher has four M/Es.

Vital Industries has instituted a cost-saving manufacturer-financing program - applicable to any Vital equipment purchase.

In accordance with our longterm commitment to more responsive television industry service, equipment purchases are being directly financed by Vital Industries itself at **10% interest**.

Recognizing the barriers raised by prohibitively high interest rates, this financing program is offered well below prime — to permit prompt acquisition, without delay, of the advanced programming and operational systems so essential to productivity and profitability.

This bottom-line economy adds to the special advantage Vital offers TV management: **a complete line of switching, video effects and station automation equipment, available from one single source** — 25 sophisticated system options, totally line compatible. Including production and post-

production mixers and switchers, plus our exclusive digital video manipulation system, the versatile Squeezoom®. All are state-of-the-art products of Vital's innovative technology; and all are now available with Vital 10% financing.

This low-interest opportunity is made possible by Vital Industries' unique financial strengths, solidly established by nearly two decade's stable performance and continuing growth. Now the largest U. S. independently-owned manufacturer of TV switching, effects and distribution systems, Vital can draw on corporate resources available from few other suppliers.

For full program details, contact our Finance Department:

(800) 874-7875 Toll Free



VITAL INDUSTRIES, INC.

3700 N. E. 53rd Street
Gainesville, Florida 32601, USA

Circle 160 on Reader Service Card

same control panel layout as the popular 1600 models, the new version of the switcher incorporates a second title keyer in the basic M/E system in addition to bordered wipes and non-additive mixing. The switcher is available with one, two, or three M/Es with up to 24 inputs and optional E-MEM and digital effects processor interconnects.

Vital Industries continued to attract attention with its huge digitally controlled four M/E switcher in the Saturn series. Almost as popular, however, was the **250 P/N**, an extremely compact digital switcher with many levels of effects capable within a single ELX (Endless Effects) M/E. Event memory for 99 complete crosspoint setups is internal while an optional CRT can display the entire crosspoint setup. Vital's Production Switcher Automation System (PSAS) was also on view on the larger switcher lines.

Ampex appears to have struck gold with its new **AVC Series** of microprocessor-controlled switchers, selling a large number of them in conjunction with the ADO effects system. The switchers feature total elimination of control knobs in favor of digital touchpads and up/down slides. Ampex also continues to market the 4100 Series of more conventional switchers.

Ross Video showed its brand new **Scene Store** effects memory system which allows storage of up to 200 switcher setups which can be recalled randomly or in sequences of up to 32 events each. The contents of the memory can also be dumped onto a micro cassette.

Crosspoint Latch is also active in this kind of switcher automation, and demonstrated it on a new **Model 6179** switcher. The three M/E system (each M/E with two chroma keyers, three colorizers, and 32-256 wipe patterns) features a speech synthesizer that tells the operator if an error has been made (such as selection of a keypad-entered wipe number that is non-existent). The microprocessor-based system can be interconnected with coaxial cable.

Crosspoint also showed a new **three M/E** switcher designed for interface with editing systems. The compact unit, priced at only \$11,600, can handle five video signals and downstream keying at the same time for highly complex effects.

Brand new to the area of production switchers, **JVC** unveiled its **KM-2000U** eight-input, single M/E switcher. Features include integral color background generator and RGB chroma keyer, 13 wipe patterns, and joy-



Ross's Scene Store.

stick effects positioning.

Echolab advanced its microprocessor-controlled **SE/3** switcher which incorporates three M/Es. Internal memory storage is provided for 5000 individual settings which can be grouped into either single-scene presets requiring some 200 memory registers or transition effects requiring some 500.

Brand new from **Asaca** was a four-camera version of its popular **ASW** portable switcher/CCU. A color background generator, two M/E banks, and several other new features are incorporated within the **ASW-200**, priced at \$70,000 including four CCUs and a four monitor display.

ISI, too, unveiled a new microprocessor-controlled switcher, **Model**

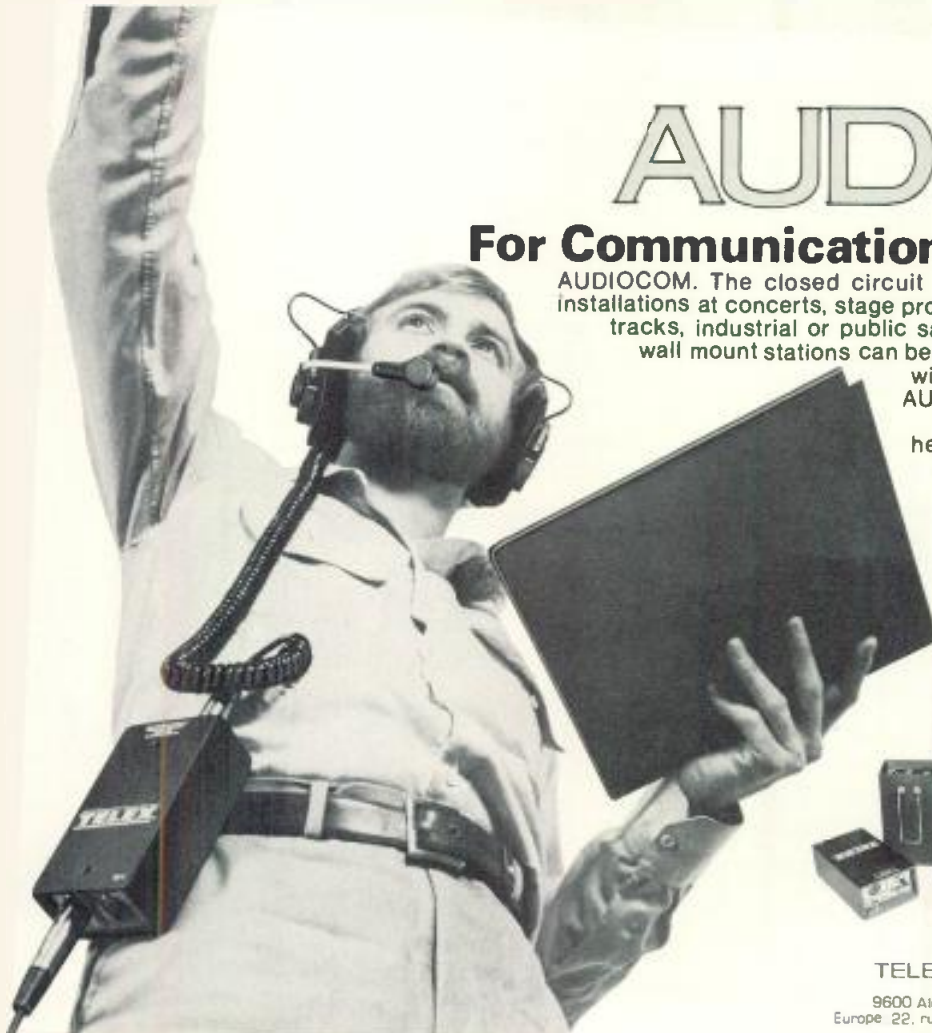

TELEX

AUDIOCOM

For Communications Behind The Scene

AUDIOCOM. The closed circuit intercom for small, large, portable or fixed installations at concerts, stage productions, film or TV studios, stadiums or race tracks, industrial or public safety applications. **AUDIOCOM** belt packs or wall mount stations can be "daisy-chained" by the dozens over five miles without degradation in signal quality or strength. **AUDIOCOM** interfaces with other sound systems and telephone circuits. **AUDIOCOM** includes headsets, mics, cables, switchboards, signalling kits, even battery packs for remote locations; the complete intercom system for communications behind the scene.

Quality products for the audio professional.



TELEX

TELEX COMMUNICATIONS, INC

9600 Aldrich Ave. So., Minneapolis, MN 55420 U S A
Europe: 22, rue de la Légion-d'Honneur 93200 St. Denis, France



Crosspoint Latch's 6179 switcher.

904. The 10-input, 2 M/E unit has an extensive wipe pattern generator that allows creation and storage of hundreds of patterns from seven basic shapes plus rotation. Features include integral downstream keyer with edging, master fade-to-black, chroma keyer, pointer generator, and audio-to-follow-video editing interface.

The **Beaveronics Model 154**, single M/E switcher priced at \$12,990 for the basic system, was aimed at mobile vans and small studios. Each mix/effects/key unit incorporates 32 positionable effects as well as full keying functions. **Shintron**, too, showed its line of **Super-switchers**.

There were also several new standalone keyers. **For-A** unveiled for the first time its **TKY-4500** title keyer with independent RGB selection of title, edge, and background colors with softness control. The ADC downstream keyer has already been mentioned. **Image Video** introduced **Model 8105** border generator, designed either to interface with its master control switchers or to function as a standalone unit. A major feature is the elimination of dithering when camera-generated graphics are fed to the switcher.

One of the most exciting new products on display was the simplified version of the **Ultimate**, **Newsmatte**, which was shown by both its manufacturer—**Vlahos-Gottschalk Research**—as well as **Central Dynamics**. The non-additive mixer, which has become a standard tool where extremely precise chromakey effects are required, has always been considered too complex for day-to-day broadcast operations until now. Interfaced with a production switcher, however, **Newsmatte** can be controlled with only two adjustments, one to set the level of the insert image and the other the level of the matte itself to eliminate fringing and switching noise associated with chromakeys.

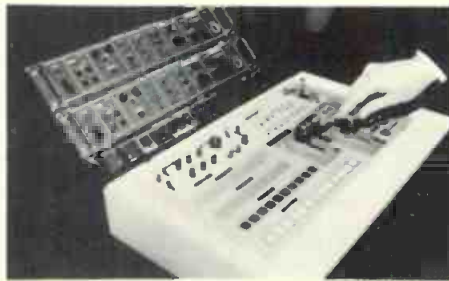

KM-2000U switcher from JVC.

A new special effects system developed by **ADC** was shown in prototype form—**ChromaTrack**. Tape footage of an exterior location is shot twice as wide as normal, then integrated with studio material through a chroma keyer. The device pans the background image as the camera pans with the performer, accomplished with a reference stripe of lighter blue background on the chromakey set. The effect allows the background to move with the action.

For more information: Central Dynamics Corp. *CD-480 Model 6S*, 524; American Data *3101-20*, 525; ADC *downstream keyer*, 526; ADC *3104A*, 527; Grass Valley *300-2*, 528; Grass Valley *1680*, 529; Vital *250P/N*, 530; Ampex *AVC Series*, 531; Ross Video *Scene Store*, 532; Crosspoint Latch *Model 6179*, 533; Crosspoint Latch *post-production switcher*, 534; JVC *KM-2000U*, 535; Echolab *SE/3*, 536; Asaca *ASW-200*, 537; ISI *Model 904*, 538; Beaveronics *Model 154 switcher*, 539; For-A *TKY-4500 title keyer*, 540; Image Video *Model 8105*, 541; Central Dynamics/Vlahos-Gottschalk *Newsmatte*, 542; ADC *ChromaTrack*, 543.

Digital effects, still stores

In the world of digital effects to accompany production switchers, several new products were on view. The most significant is probably **NEC's** brand new **E-Flex** system which will complement the popular **DME**. The system offers expanded capabilities such as curved-line transitions between two pre-set patterns, dual channel capacity, 16, nine, or four images in multifreeze

operation, mosaic effects, and an integral effects border program. Part of the design philosophy is ease of operation and low cost (\$63,000 basic) so the system can be rapidly integrated into a medium-sized production facility or station. Accompanying the processor is an optional \$4500 bubble memory unit that stores 512 customer-created digital effects patterns in a miniature cassette half the size of a pack of cigarettes.

Another new digital effects system was unveiled by **Toshiba**, dubbed **Digital Picture Effect (DPE-II)**. The full-function unit, incorporating basic effects patterns such as compression, expansion, mosaic, mirroring, matte following, and so forth, uses Y,I,Q encoding in the effects processing, but also incorporates a composite synchronizer.

Advances were also made in the **Vital SqueeZoom** system. Now, in addition to the extensive repertory of preprogrammed effects, operator-created effects patterns can be easily assembled and then stored for later recall. Three modes—crop, tumble, and compress/position—are controlled through the fader bar.

MCI/Quantel has added a new dimension to digital effects with **Dimension**, a software package that works in conjunction with the rotation effects option for the **DPE-5000+**. In addition to adding picture perspective it provides for H and V picture splits, multifreeze, trailing freeze, and **TeleTrack**, the BBC-developed equivalent of **NEC's** **ActionTrack/Digital Strobe Action**.

The **Ampex ADO** three-dimensional effects processor has been mentioned. The product appears to be catching on, with increasing sales reported. **ADO** was demonstrated with 13.5 MHz sampling rate, perhaps the first product to reach the market that employs the new **SMPTE/EBU** digital sampling standard. A four-channel version of the system appears in the offing, though not demonstrated at **NAB**.



NEC's E-Flex system.

Ready to shoot. Under \$10,000.*

Ikegami's ITC-730 brings high performance ENG/EFP to the budget-conscious broadcaster. This 3-tube prism optics camera delivers a new measure of flexibility and reliability at a price never before achieved. It comes ready to shoot, complete with gen-lock, 10:1 Fujinon zoom lens, 2/3" Saticons,** battery pack/charger, AC adapter and carrying case for under \$10,000.

Yet, the ITC-730 incorporates the technology pioneered by Ikegami in previous ENG cameras. It offers professional grade components and exceptional features. For example, the fast f/1.4 prism beamsplitter with low-noise preamplifier delivers excellent low light level performance. S/N ratio is an honest 54 dB and sensitivity is 2000 lux at f/4.

Bias light reduces lag and dynamic beam stretch reduces highlight trail.

Low power consumption of only 17 watts lets you shoot for hours. And that all-day shoot won't leave you all worn out—the ITC-730 is not only lightweight, but also well-balanced. Its low profile design makes it easy to handle, easy to see over. The housing is a rugged die-cast alloy that can stand daily punishment.

For EFP, add the optional CCU and 5" viewfinder and the versatile ITC-730 can cover your production schedule indoors or out. Call for a demonstration of the ITC-730. Available now, it's everything you'd expect from Ikegami.

Ikegami ITC-730

* ENG configuration
** Registered trademark of NHK



Ikegami Electronics (USA) Inc., 37 Brook Avenue, Montclair, NJ 07607; (201) 368-9171
Northeast: (201) 368-9171 □ West Coast: (213) 534-0050 □ Southwest: (713) 443-0100 □ Southeast: (813) 884-2046 □ Canada: (201) 368-9179

Circle 143 on Reader Service Card

www.americanradiohistory.com

In addition to the digital effects system described above, digital still stores continue their evolution. **Harris Video System** proudly rolled out a new version of its still store, **Iris II**, capable of providing up to six simultaneous users with on-line access to 15,899 stills. An optional library program provides off-line sorting, storage, and retrieval of 90,000 stills. The computer disk packs can be subdivided into 10 separate sec-



Iris II from Harris Corp.

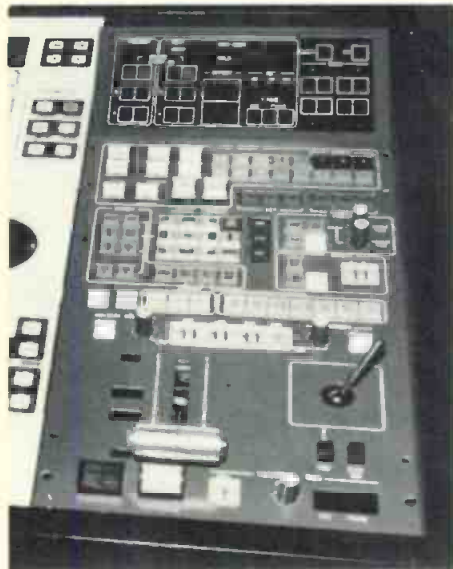

Toshiba's DPE-II effects unit.

compressor/positioner can be integrated with the system to provide additional on-air production capability and supplement the internal frame compression and display programs built into the system. VIP is also being marketed as a standalone, economically priced digital effects system for use with both still and live images; digital time base correction is an option.

For more information: NEC *E-Flex* system, 544; Toshiba *Digital Picture Effect (DPE-II)*, 545; Vital *SqueeZoom*, 546; MCI/Quantel *Dimension*, 547; Ampex *ADO*, 548; Harris Video System *Iris II*, 549; Quantel *DLS-6030*, 550; ADDA *ESP*, 551; ADDA *VIP*, 552.

tions, allowing each user to create and maintain his own individual file.

Quantel's **DLS-6030** was also on display, now providing an equivalent library search function through keyboard-entered identifying captions. Stills can be organized into stacks for review, with full-frame preview. The contents of the disks can be dumped, in digital form, onto standard videotape for archival storage or transportation to another location.

ADDA, too, showed its **ESP** still store, again offering massive disk storage of stills and library control to help manage the files. ADDA's **VIP** digital

Master control, automation

There were few entirely new entries in the master control field at this year's NAB. One exception was **Vital Industries' SAM (Station Automation Manager)** system, which marks a new approach to station automation. This computer-controller system automates all equipment relating to on-air operations and interfaces with any business automation system. Based on a DEC **PDP-11/23** computer system, **SAM**

Your image is on the line.

Barco's broadcast color monitors put your image on the line—clearly.

With the **CM-33B 13"** and **CM-51B 19"** monitors you can choose from a medium, standard, or high resolution delta dot tube. Your choice. But all three assure the broadcaster a color critical picture that lets you know exactly what is going out on line.

The medium resolution **CM-33B** offers a phosphor

triad pitch of .43 millimeters and the **CM-51B .47 millimeters**. Other features include • Switchable underscan/overscan, • RG off switch for easy set-up, • Color temperature switch.

All models are fully modular and are designed for general purpose applications. The **CM-33B** is ideal for **ENG/EFP** applications and the **CM-51B** is perfect for studio use.

We know your image is on the line. Barco's worldwide reputation for quality is sure to enhance your image.

Available from Elector, U.S. distributor of Barco communications products.



In the U.S.
Elector U.S.
5128 Calle del Sol,
Santa Clara, CA 95050
Phone: 408/727-1506
Telex: 0236/0172335

In Canada
Electro & Optical Systems Ltd.
31 Progress Court,
Scarborough
Ontario M 16 3V5
Phone: 416/439-9333
Telex: 021/06525431



Circle 163 on Reader Service Card

It deserves an Oscar

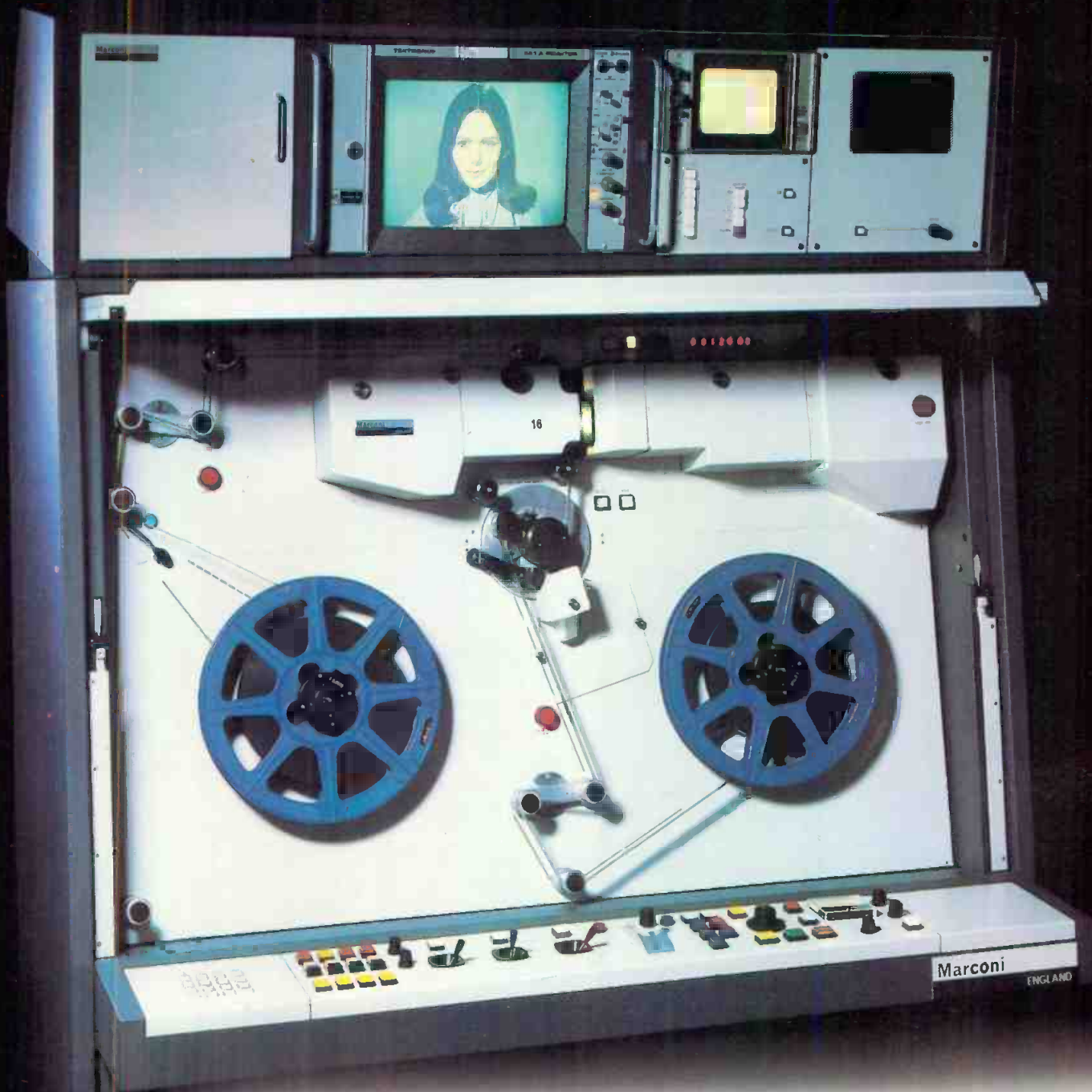

The New Marconi Line Array Telecine B3410

For a remarkable contribution to film in TV, Marconi's new Line Array Telecine B3410 fully deserves its great reputation.

The unique combination of full digital processing with micro-processor control and CCD sensors means exceptional picture quality, shorter set-up times, rapid change of TV standards, long life and minimum maintenance. No tubes, no replacements!

Also offering fast change of film gauge and full resolution Cinemascope, this most outstanding newcomer is available for swift delivery at a highly competitive price.

For full details contact: Marconi Electronics Inc. (John White or Simon Frazer)

Marconi
Electronics Inc.

Tel: (201) 767-7250 or A. F. Associates
Inc. (Richard V. Lunniss or Bill Ebell)
Tel: (201) 767-1000.



100 Stonehurst Court, Northvale, New Jersey 07647. U.S.A. Tel: 767-7250, Telex:
710-991-9752.

Circle 164 on Reader Service Card

www.americanradiohistory.com

Introducing... Affordable, State-of-the-Art Graphics!

Until now, state-of-the-art news and weather graphics equipment was simply too expensive for most broadcasters. Satellite Broadcast Network has changed all that. We've combined the most technologically-advanced graphics generating equipment with the largest privately-owned weather satellite ground station. We supply the highest resolution weather & news graphics to our clients via satellite. What's more, our system is addressable, so you ask for and get exactly what you need!



SBN's team of graphic designers monitor breaking news stories and create bold, crisp, high-resolution graphics. These are transmitted via satellite from our ground station for re-broadcast to subscribers. Because the

SBN system is fully addressable, you can select the graphic style that best meets your needs, thus establishing your station's own unique look. Custom graphics for local news, station promo's etc. are also instantly available. The high resolution (300,000 pixels per frame) of SBN graphics will put you ahead of the competition at a fraction of the cost of owning your own graphics system.

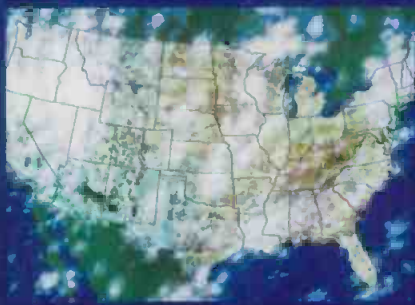

SBN supplies color weather satellite imagery 24-hours a day that, without qualification, is superior in quality and resolution to that offered by any competitor. Clients may receive 96 national images a day, visual as well as infrared, from the East and West Coast weather satellites. In addition, sectors are available and SBN can supply customized sectors if desired. You receive high-quality images, not cartoon-like maps, direct from SBN's ground station via satellite. This means you save on telephone line costs and images you receive maintain highest quality.

Receiving equipment at your station is the link that brings you the highest image resolution available in the broadcast industry. SBN's receiving system, features NEC equipment to give subscribers the best display resolution available. Utilizing



technology perfected in NEC's Emmy Award winning broadcast television products, the SBN receiving system is without equal. The quality of images received rivals that of expensive 35mm slides and the signal is full NTSC.

**SBN...unlocking the doorway to tomorrow!
You've always wanted the very best and now, with SBN, you can afford it!**

**SATELLITE
BROADCAST
NETWORK
INCORPORATED**



T.M.

190 N. STATE STR. • CHICAGO IL 60601 • (312)263-6921

features modular automation software that can be customized to meet individual needs. A special advantage of the system is QRCP, the Quick-Response Control Panel, which allows the operator to switch quickly into manual control when necessary and return to automation easily.

Central Dynamics' APC-920 automation system, originally exhibited last year, showed up in a new true-time version. This PROM-based, flexible system allows the operator to completely design the formats of the schedules and displays at each terminal; different operators can design that suit their individual needs. A special feature is the wide selection of audio transition types. The updated system is scheduled for July delivery and will cost around \$65,000. The company also showed the system's predecessor, the APC-10 automation system.

Utah Scientific premiered its **PLMC-1** party line machine control system, which can function by itself or integrated with the **AVS-1** routing switcher. This flexible system can be customized to fit individual needs and operates with serial data transmitted over coax party lines, eliminating the need for a separate machine control switching matrix. "Hot standby" control and memory backup are available.

Several companies showed previously exhibited machine control systems. **Dynamic Technology Ltd.** brought its **VIMACS** microcomputer system, which controls machine sources via the vertical interval of the video signal. The company also featured its **SAMS** and **WISE** vertical interval source and message senders.

Dynair's System 23 controls as many as 64 functions of up to 1000 machines—from as many locations, if required. The expandable system comes standard with an automation interface.

3M's 6500 machine control system, also seen before, is built around a compact machine control panel with touch-pad selection. Its video terminal is capable of salvo command, which allows simultaneous control of several machines.

Grass Valley Group once again brought its modular **M200** system,

which features a building-block approach that allows a wide range of machine control options. Expansion of the system is by means of plug-in cards.

Featured at the **ISI** booth was the **TAS** computer controller from **Command Concepts, Inc.** This system offers unlimited event storage with 4000 on-line events, plus interface to any switcher and to business automation systems.

Another new system was **Relecon**, from **Applied Digital Technology**. **Relecon** controls level and switch settings for most standard video processing and display equipment and stores hundreds of scene changes. Updates are keyed to SMPTE time code.

At the **N-Z Video** booth, the featured item was the **SOL-6800** automated broadcasting system from **Solutec**, a Canadian company. The system has been available for about three years, but this was its first NAB appearance. It features microprocessor control of up to eight VTRs. Internal memory can handle 99 events; floppy disks can expand this capacity greatly. Any 3/4-inch, one-inch, or quad VTR with remote control can be used with the system.

Compact Video Technology introduced the all-new **CTS-800** computer-assisted **U-Matic** playback system, which operates in sequential or auto-random modes and prints out a hard-copy log. Each basic switcher controls six machines and offers manual start or automatic start from a broadcast computer or satellite cue tones. The company says the system totally automates news and commercial insertion at television stations.

Bosch Fernseh brought its established **TCS-1** machine control system, which controls up to 100 VTRs or film chains via dual twisted pair wiring. The system's central microprocessor can be programmed for such special functions as permanent assignment of particular machines to specific control panels.

Microtime introduced its **C-150** commercial inserter, designed primarily for cable television operators. The inserter controls up to four VTRs.

Seen for the first time at NAB was **Kavco, Inc.'s Kavcart** system, which control's eight Sony **BVU-800** VCRs.



Utah Scientific's PLMC-1 controller.

The expandable system is built around the **Kavtrol** programmable microcontroller, an interactive, software-based system.

Lake Systems Corp. introduced **La-Kart**, a computer-based, random access TV cart system, expandable up to 32 decks. Aimed at the small broadcaster, the **La-Kart Series I**, with five Sony **VP-5000** players and one **VO-5850** recorder, sells for \$89,990.

An exception to the trend toward microprocessor control was an extremely simple modular two-wire machine control system from **Auburn Instruments**, the **MC/1**. The system has no computer control at all; a simple remote control unit controls up to eight commands and eight return tallies on a single pair of wires. Five to 10 of the remote panels, each controlling a single machine, hook up to the **MC/1-IU** interface unit.

For more information: Vital Industries **SAM**, 553; Central Dynamics **APC-920**, 554; Utah Scientific **PLMC-1**, 555; Dynamic Technology **VIMACS**, 556; Dynair **System 23**, 557; 3M **6500**, 558; Grass Valley Group **M200**, 559; ISI/Command Concepts Inc. **TAS**, 560; Applied Digital Technology **Relecon**, 561; N-Z Video **SOL-6800**, 562; Compact Video Technology **CTS-800**, 563; Microtime **C-150**, 564; Kavco Inc. **Kavcart**, 565; Lake Systems **La-Kart**, 566; Auburn Instruments **MC/1**, 567.

Post-production

Evolutionary changes were also in evidence in the busy editing systems booths. From **A** (Ampex) to **V** (Video-media) and companies in between, the accent was on user-friendly systems.

In addition, manufacturers stressed the ability to upgrade editors depending on the user's needs, from relatively simple controllers to complex systems involving multiple VTRs under computer control. And a few companies were touting the ability to add greater sophistication to previously sold editors by retrofitting new control boards and PROMs.



Dynamic Technology's VIMACS system.

The technology that went into the initial high-priced systems has worked its way down to lower-cost equipment designed to make computer control affordable to smaller stations and post-production houses. Thus, Ampex, which had previously unveiled the high-end ACE TouchScreen system, came to the NAB with the new HPE-104. Designed for on- or off-line editing with helical VTRs in the one-inch or 3/4-inch format, the 104's microprocessor allows the user to command up to four VTRs with one simple control. Time search provides direct, automatic



United Media's Director system.

CO-AX DIGITAL REMOTE CONTROL



... from distances up to 5000 feet!

For just a fraction of the cost of other systems, Cinema Products' co-ax digital remote control system provides studio-like remote control to ENG/EFP cameras in the field.

Just like most other systems do. Only better. And from greater distances.

Because our co-ax control system eliminates the need for expensive, bulky, multi-core or triax camera cables—reducing to a minimum the risks normally associated with the use of such cables.

Digitally-encoded camera set-up and control data (including genlock) are relayed by low-cost,

simple and lightweight coaxial cable from greater distances—up to 5000 feet!—with greater safety and utmost reliability. Which makes our co-ax control system ideal for all those rugged location extended-shooting situations.

Cinema Products' field-proven co-ax digital remote control system is available in both NTSC and PAL-B standards (where applicable) for a full range of professional ENG/EFP cameras such as Sony BVP-250/300/ BVP-330, Thomson MC-501/601/701, RCA TK-76B/76C, Ikegami HL-77/ HL-79A, Sharp XC-700, etc.

Co-Ax system shown with Sharp XC-700.

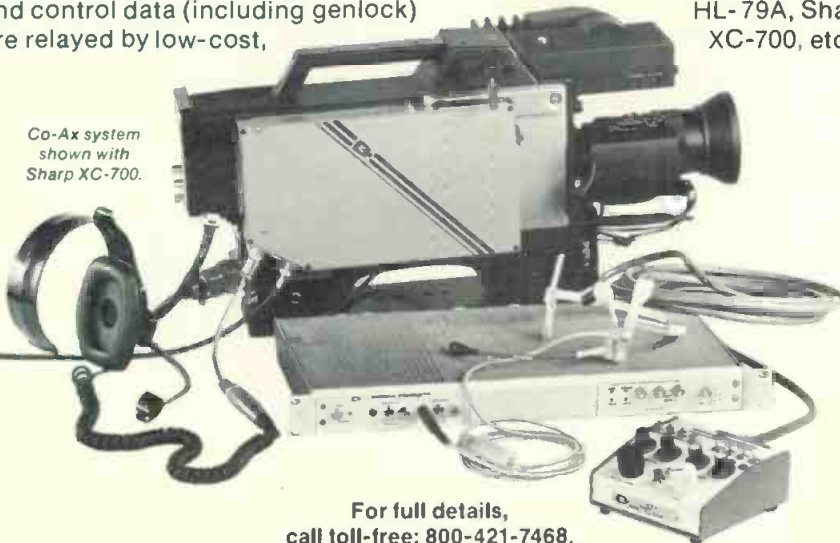

For full details, call toll-free: 800-421-7468.

cinema products
CORPORATION

Technology In The Service Of Creativity
2037 Granville Avenue, Los Angeles, California 90025
Telephone: (213) 478-0711 • (213) 477-1971 • Telex: 69-1339

access of the decision list to any time location on the record or source tapes with a simple keyboard entry. The HPE-104 is priced at \$47,500 for the basic system and will be ready for delivery in 60 to 90 days.

A good example of software enhancement is Datatron's Vanguard editing system. With the addition of two E-PROM circuit boards, the Vanguard is armed with a new feature—HELP—that comes to the rescue of the user in distress. By pushing the HELP (for Helping Editors Learn Procedures) button, the editor brings up a display of prompts that walk the user through the proper procedures. In this way it is not necessary to memorize complex call-up codes. This feature and other software improvements can be retrofitted into present Vanguard systems. Basic price for Vanguard is \$55,000.

Among the other second generations on hand was the Bosch Fernseh Mach One Series II. In addition to all the capabilities of the software-based Mach One, the Series II includes dual-channel audio control, variable speed control, programmable slow motion, updated edit list formatting, cluster-event programming, and screen highlighting for easier reading. Cluster-event programming permits the editor to program extremely complicated multiple events in a cluster treated as a single event.

The Harris EPIC editor also boasts



HPE-104 editing system from Ampex.

**OUR
PICTURE**

VS.

**THEIR
PICTURE**

**LENCO'S
NEW PCE-462
COLOR ENCODER
WILL SHOW
YOU THE BEST
RGB TO NTSC
IN THE BUSINESS
— FOR
BROADCAST
AND COLOR
COMPUTER
GRAPHICS.**

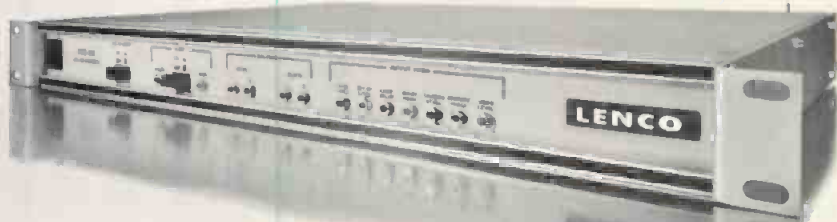

LENCO

Circle 167 on Reader Service Card

Now give yourself a clear advantage — with a picture that's clearly better. Not just visually, but cost-wise, too.

Lenco's new PCE-462 takes RGB sync, blanking, sub carrier and optional luminance and gives you NTSC out — with such high resolution superiority that we'll be glad to compare it against anybody else's.

Now you can upgrade picture quality at a fraction of the cost of other equipment. And enjoy enhanced results from compatible graphics computers with RGB out.

Frequency response. Compare this Lenco at ± 0.3 db to 6.5 MHz, to -3 db at 7.5 MHz. Truly outstanding performance.

Enhancement. Compare Lenco sharpness with signal boost of +8.3 db at 3.5 MHz.

Non-composite RGB or composite green. This Lenco video input processor accepts either without modification.

Luminance channel input optional with plug-in circuit board. Now you can up-date your older 4-tube cameras instantly. All the hardware is here — BNC coax connectors, internal wiring, etc. Just plug in for your clearest color ever.

LENCO'S FREE OFFER



It will improve your picture right now.

Write or call us today. We'll send you a spec sheet on the PCE-462 and give you a side-by-side comparison spec check with all other units now available: the answers you want — direct from our engineers.

Call 314-243-3147

Have your sales representative call-me. Send literature and comparison.

Name (please print) _____
Title _____
Firm or station _____
City _____ State _____ Zip _____
Telephone _____

Lenco, Inc., Electronics Division, 300 N. Maryland St.,
Jackson, MO 63755 (314) 243-3147

some new features. Essentially, Harris has extended the general purpose interface capability to make EPIC function with almost any ATR and VTR and most video switchers. It provides complete control of all VTR functions. EPIC, of course, has a film edit capability which is made with a separate program disk plus complementary equipment such as Grey Engineering time code systems.

Similarly, **Convergence Corp.** demonstrated at its suite its list management Model **ECS-104** with a newly expanded chassis to allow for more source VTRs. New software enhancements and added features such as slow motion on one inch VTRs were also available. In addition, **Convergence** demonstrated its new EDL option for the **ECS-90** Editing System. The **ECS-104** Edit Controller is priced at \$36,000 and the **ECS-90**, \$4250. Delivery is in 30 days.

CMX/Orrox has also added new capabilities to its line. The company featured **Look Ahead** in its **340X** system to speed up operation by previewing or recording multiple events virtually in real time. It eliminates waiting for machines to catch up or rewind, resulting in cost and time savings. **CMX** has also developed software enhancements for the two-year-old **EDGE** system, including stereo audio or split audio editing, internal event memory, event re-edit, list scroll, and list ripple by block or entire list. The price with new features included remains the same; a three-machine system sells for \$23,450.

With the expandable **Commander II** editing system, **United Media** demonstrated a system that allows the buyer to build a progressively more sophisticated editing capability, starting with a basic two-machine setup and running up to multi-VTR interfaces and increased editing capabilities. The basic **Commander II**, at \$16,500, provides two VTR interfaces (either one- or 3/4-inch), two built-in SMPTE time code readers, 100 events of internal



CMX's *The Edge*.



Sony's **BVE-5000** editing system.

memory, and a standard RS-232 output. At the top of the line the system can accommodate up to eight ATRs and VTRs at a cost of \$43,380. Options range from a CRT data monitor to a slow motion capability.

United Media also unveiled its new audio editing system, the **Director**, interfaced with the **Commander** editor. The system is used for highly precise audio dubs onto videotape with frame-accurate precision.

Ranging in price from \$10,800 to \$32,500, an expanded **Z6000** family of A/B roll editors was demonstrated by **Videomedia**. The upper-range models include a dual eight-inch floppy disk that not only adds file capacity but contains a diagnostics program. New at NAB was a **Z6000** interface to the Otari 5050 eight-track ATR.

Control Video made a hit at last year's show with the **Lightfinger**, a touch-activated editor providing monitor displays of basic editing functions such as time code cuing, "play," "stop," and so forth; in July **CVC** will have available **Lightfinger Plus**. While the original model does cuts only and costs \$18,950, the Plus version will have A/B roll software and accommodate special effects by way of a switcher at a cost of \$27,000.

Sony followed up on the **BVE-3000** unveiled last year and upgraded this year with an even more powerful **BVE-5000** for on-line and off-line editing. The program contained in ROM has audible and visual prompts through the edit sequence with event validity verification.

Also drawing attention in the **Sony** booth was the **BVE-800** editor designed to work with its **BVU-800** and **BVU-820** 3/4-inch VCRs. Aimed at EFP and ENG applications, the **BVE-800** three recorder editor can also be interfaced to mixed combinations of VTRs.

Competing with the **BVE-800** is the new **CR8250** 3/4-inch editor from **JVC**. The unit's design makes it impossible to lose control track or SMPTE time code with its built-in time code generator and reader. While past the prototype stage, firm price had not yet been set.

Of interest in the **Panasonic** display was its editing controller for 1/2-inch tape, the **AU-A30**. It fits with **Panasonic's** **ReCam** camera-recorder combination family and is priced at \$3800. Delivery is set for the end of July. It is designed to control the new **AU-300** studio VTR which is also part of the **ReCam** family.

Cezar International added to its line of microprocessor-based editing products called the "**Originators**", which includes the **Editing Centre**, the **Decision Maker**, and the **Controller**, plus the new **Collator**. In addition, the company promised a new editor in the fall to work with its **IVC-1** component tape recorder described in the VTR section.

The **Editing Centre**, priced at \$5995, has an animation capability in either manual or auto. In the latter, the user sets up the scene and camera, puts the system into auto mode, and presses the **PERform** button to roll the VTRs. Then the user has five seconds to change the scene which is recorded again automatically until a completed sequence is recorded.

Jetex showed an upgraded version of its **VSEC-62TMX** lost cost A/B roll editing controller that now has full computer assist. This unit features plug compatible interfaces so that it will work with most 3/4-inch machines with no modifications to the VCR.

For more information: Ampex **HPE-104**, 568; Datatron **Vanguard**, 569; Bosch Fernseh **Mach One Series II**, 570; Harris **EPIC**, 571; Convergence Corp. **ECS-104**, 572; Convergence Corp. **ECS-90**, 573; CMX/Orrox **340X**, 574; CMX/Orrox **EDGE**, 575; United Media **Commander II**, 576; United Media **Director**, 577; Videomedia **Z6000**, 578; Control Video **Lightfinger Plus**, 579; Sony **BVE-5000**, 580; Sony **BVE-800**, 581; JVC **CR8250**, 582; Panasonic **AU-A30**, 583; Cezar International "**Originators**", 584; Jetex **VSEC-62TMX**, 585.

Time code

As editing systems have become more sophisticated, so have the time code generators and readers associated with them. Again, the microprocessor is

2

VTR

ON

CRUISE



Modern art.

The science of video production is certainly modern art. There is no better example of the human ability to combine imagination with technology and experience to change the way we communicate.

Convergence Corporation is an integral part of the video revolution. We make the best video editing systems money can buy. And yet, it's surprising how little it costs to own the best.

But there's something about Convergence editing systems that's even more important than quality and price. And that's the way they perform. They're designed to be operated by people - not computers. They don't get in the way of the creative process, but actually make

it easier to combine skill and imagination to produce a finished product that's a thing of beauty.

Convergence Corporation. The modern art of video editing systems.



1641 McGaw, Irvine, CA 92714 Tel: (714) 549-3146, Tlx: (910) 595-2573 • 250 W. 57th Street, Flak Building, Suite 815, New York City, NY 10019 • 1 Lochaline Street, London W6 9SJ U.K. Tel: 01-741 7211, Tlx: 851-27950 MONREF G

Circle 166 on Reader Service Card

www.americanradiohistory.com

Currently at reduced prices

From the Neumann Collection

The undisputed star of stage, screen and television is Neumann's KMS 84 condenser microphone, specifically designed with the soloist in mind.

This rugged performer is insensitive to popping and overload caused by close-up, hand held use. It's also insensitive to the noise caused by fingers gripping the case.

With the KMS 84, the recording artist now has the same high-quality Neumann microphone on stage that was previously available only in the recording studio.

Accessories include six different color-coded, easily interchangeable wire mesh grilles to facilitate identification on stage. Write or call today for a brochure and listing of dealers near you.



GOTHAM

AUDIO CORPORATION

741 Washington St., New York, NY 10014 • (212) 741-7411
West Coast Office: (213) 874-4444

GA-20

TELEVISION DEMODULATOR QSI DEMOD 400



The Demod 400 off-air demodulator helps you clean up your act. Now you can stabilize off-air signals

without tying up an expensive proc-amp. The Demod 400 gives you the choice of straight off-air signals or replacement sync, burst and blanking at the flip of a switch.

Plus you have control over sync and burst amplitudes, burst phasing, and set-up level during processing. There's even a built in speaker to make life easier. All this at a price that won't deflate your budget.

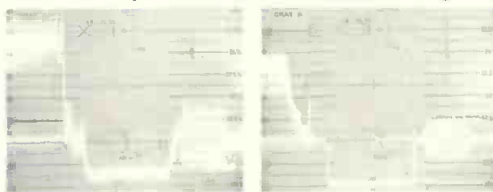

UNPROCESSED

PROCESSED

QSI

For more information about the Demod 400 call (617) 938-1403, or write to us.

QSI® Systems, Inc.

12 Linscott Road, Woburn, Massachusetts 01888

Circle 168 on Reader Service Card

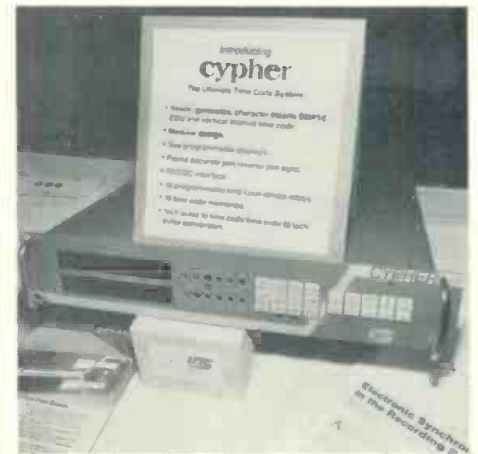

Cypher time code system from BTX.

making its way into an entire equipment category.

For example, **BTX** showed off **Cypher**, which simultaneously reads, generates, and character inserts SMPTE and VITC data. It reads longitudinal time from 1/50th to 60 times play speed and VITC from still frame to maximum wind, all under microprocessor control. Complete unit costs \$5500 and delivery is in 60 days. **BTX** also showed the latest version of **Shadow**, a fully intelligent synchronizer for audio, video, and film transports specifically designed for direct computer interfacing.

Ampex Corp.'s new entry was **Unisyn**, a post-production synchronizer with a universal interface to audio and video recorders. Unisyn's wide range, continuous variable speed lock allows the slave recorder to lock to the master even as master speed varies dynamically from one-quarter to twice play speed. Each slave recorder can locate and synchronize 10 separate segments in one separate pass of tape on the master; eight optically isolated, time code-controlled outputs are assignable to 10 events. The user can choose from time code or machine tach pulse cuing. Unisyn costs \$6450 and will be deliverable in August.

Audio Kinetics featured its popular **Q-Lock** synchronizer operating with either SMPTE time code or control track for constant reference. Jam sync operation is totally automatic, together with a new genlock sync generator for when time code fails. Five events are stored in internal memory.

Skotel Corp. debuted a raft of time code generators, both SMPTE and VITC. One interesting unit was the **PTC-100** portable time code generator/reader weighing just 1.8 lbs. Intended for field production, it includes a reader with jam sync capability. In the absence of an external reference, the unit operates on its internal crystal-controlled oscillator.

Datametrics has placed its bets on

The Quantel DLS 6030.

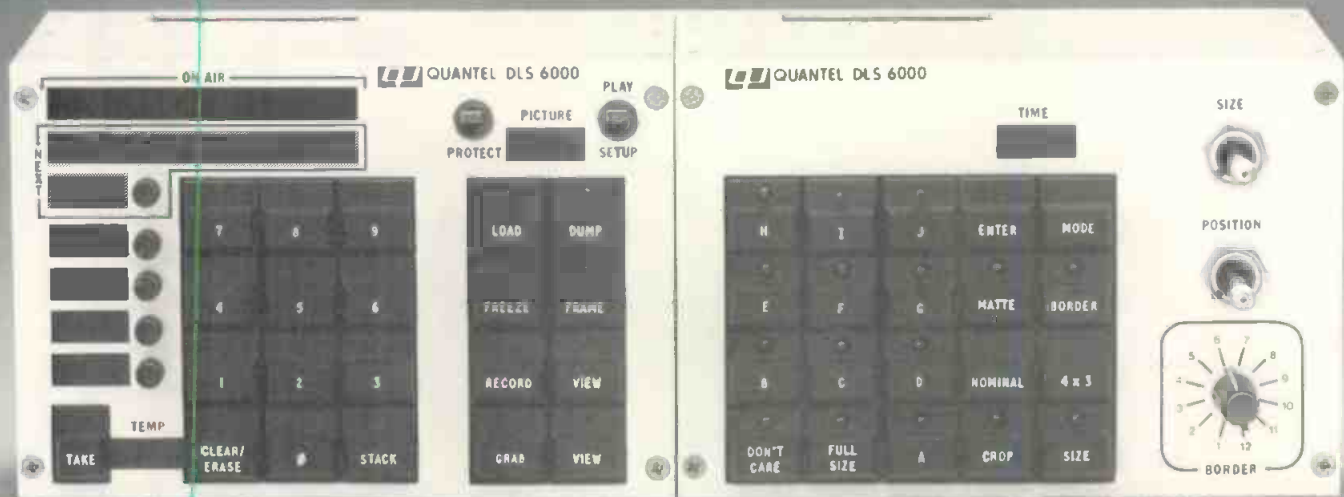

Every other way to store stills is obsolete.

Introducing the state-of-the-art in electronic still-storage—the Quantel DLS 6030 digital library system.

Obviously it stores still pictures. Up to 800 on each small Winchester disk drive. And with the quality that is a hallmark of Quantel. But the DLS 6030 goes far beyond still-storage.

It is the only electronic still-store with production effects capabilities. So now you can compress still pictures to any size. Crop them to remove unwanted material. Position them anywhere you want. Put borders around them. And dissolve from one shot to the next.

You can even build up totally new pictures—composites or montages—from existing material.

And you can always retain your "originals" in their pristine state.

The DLS 6030 lets you browse through its disk library to select the pictures you need, and gives you unprecedented facilities for on-air editing, previewing, and presentation.

Off-loading? You can dump all the pictures—in digital form—onto

standard videotape. Then reload at the remote site via any VTR. The transfer is digital, so there's no generation loss.

Because Quantel's technology is leading-edge, the DLS 6030 is small—about one-quarter the size of still-stores using older technology—and draws far less power. So it's ideal for mobile operations as well as the studio.

There's nothing else like it. See for yourself. Call your local MCI/Quantel representative. Or get in touch with us directly at 415/856-6226. Micro Consultants, Inc., P.O. Box 50810, Palo Alto, California 94303.



MCI/QUANTEL
The digital video people.

MCI/Quantel is a trademark of Micro Consultants, Inc.

Circle 200 on Reader Service Card

www.americanradiohistory.com

the vertical interval time code. The **Model 760 and 766 VITC reader and generator** were introduced featuring a multi-source keyer—important in multi-camera production—priced at \$1850.

ESE, on the other hand, voted for SMPTE time code with its new **ES 255** reader with video generator. Priced at an attractive \$995, the ES 255 has a reading speed of 1/20th to 20 times play speed. **ESE** also introduced a micro-processor-based programmable timer, **ES 790**, with 1000 event memory and priced at \$2950.

EECO came out for VITC with two new products—**VIG-850** generator/reader and **VIR-950** reader. Besides handling VITC, both can switch over to the hexadecimal word format for user bits display. These units also offer built-in self-test diagnostics. The reader uses transport tachometer pulses as a backup timing source.



EECO showed new VITC products.

In the SMPTE camp, **Amtel Systems** unveiled **Model 3700** and **Model 3800A Edit Code Master**. They have 20-key control panels for setting various functions and feature momentary and continuous jam sync modes.

Adams-Smith is in the VITC camp with a unit capable of reading code up to 45 times play speed but providing an output in longitudinal code format for editing interface.

Separate standalone time code reader and time code generator, the **BVG-1500** and **BVG-1600**, were in the **Sony** exhibit. They handle longitudinal and vertical interval time code.

Others showing time code products were **Coherent Communications** with its film and tape system, **EEG Enterprises** with line 21 encoder and decoder, **For-A**, and **Shintron**.

For more information: **BTX Cypher**, 586; **Ampex Unisyn**, 587; **Audio Kinetics Q-Lock**, 588; **Skotel Corp. PTC-100**, 589; **Datametrics Models 760, 766, 590**; **ESE 255, 790, 591**; **EECO VIG-850, VIR-950, 592**; **Amtel Systems Models 3700, 3800A, 593**; **Sony BVG-1500, BVG-1600, 594**.

Digital signal processing

New digital products for time base correction, frame synchronization, color correction, and so forth seem to be turning up by the minute, with many manufacturers now offering low-cost systems for every TV application.

New product offerings in this area included **Microtime's S-130** digital framestore synchronizer, priced at less than \$11,000. Freeze field or frame capacity is offered with an ability to make hot switches between non-synchronous sources. Advanced micro-processor design allows the subcarrier sampling-based unit to store digital information inexpensively rather than in extensive dedicated memory.

Microtime joins other manufacturers such as **NEC** and **MCI/Quantel** already in the low-cost synchronizer market. **Quantel** this year introduced a brand new **digital audio delay** unit to complement its video line, sensing the need to pay attention to audio since video loses a frame each time it passes through a synchronizing or timing device.

A significant new product introduction was also made by **Harris Video Systems** with its 3.5-inch high **HVS-690**. The framestore synchronizer/TBC uses 9 bit sampling to yield a differential gain of ± 2 percent, differential phase of ± 2 degrees, and signal-to-noise ratio of 59 dB. The unit is priced at \$15,500.

A major force in this market, **Digital Video Systems** is also heavily committed to its **Phaser** line of digital products, starting with a less-than-\$10,000 digital TBC and progressing to the brand new \$14,950 **Phaser VI**. The latter combines a full framestore memory with a comb filter to provide highly stable freezes. A fieldstore synchronizer, **Phaser IV**, is available for \$9980.

This building block approach to digital products was also evident in a new line from **Fortel, Digibloc**. Depending on the needs of the customer, it can be configured anywhere from a low-cost digital TBC for less than \$10,000 to a unique two-frame synchronizer, prob-

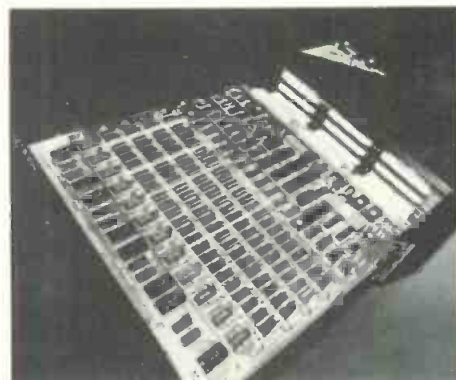

Digital Video brought the Phaser line.

ably less than \$15,000. Besides the two-frame capacity of the larger system, another unique feature of **Digibloc** is its ability to switch between eight and nine bit sampling depending on how much processing is required. An adaptive three-line comb filter, a drop-out compensator, and remote control capability are optional. **Fortel** also announced it would take over U.S. marketing for the **Faroudja Labs Image** system, a noise reducer/image enhancer for use with VCRs. The new **Digibloc** system is sensitive to the **Faroudja** processing signals.

A new exhibitor at NAB, **Apert-Herzog** also brought a compact framestore synchronizer. Eight bit, 4X fsc sampling is used, providing synchronization and either field or frame freeze. Video is stored in 16K RAM in composite form while a comb filter is used to separate Y and C after storage.

Yet another new digital video synchronizer, **VS-IV**, was shown for the first time by **Toshiba**. The unit features a one-line buffer memory to aid in switching between non-synchronous sources and could be labeled as "transparent," considering its excellent specifications. Like **Quantel**, **Toshiba** also has a digital audio delay circuit to match the video processing.

Off to a running start on a modular digital system was **ADDA**, which introduced the **AC-20** dual channel digital TBC. Designed to be used with 3/4-inch VCRs during post-production, the unit can currently be configured to include 2:1 digital effects such as two-channel wipes and squeezes. In the future, additional plug-in cards may

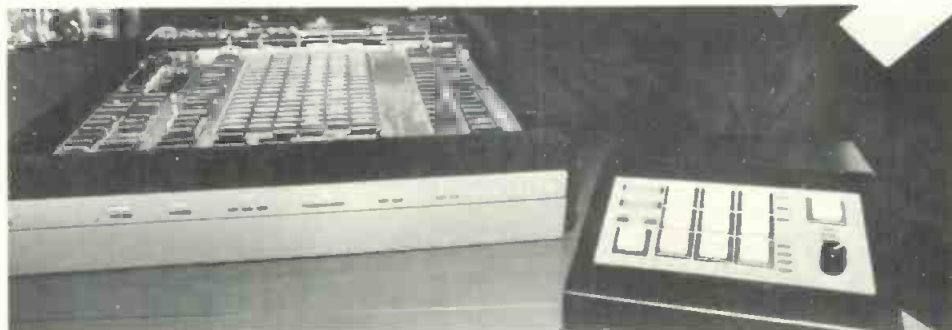

Fortel's new Digibloc line.

THE ONLY FULL CAPABILITY VIDEO NOISE METER IN THE WORLD

AVAILABLE NOW!

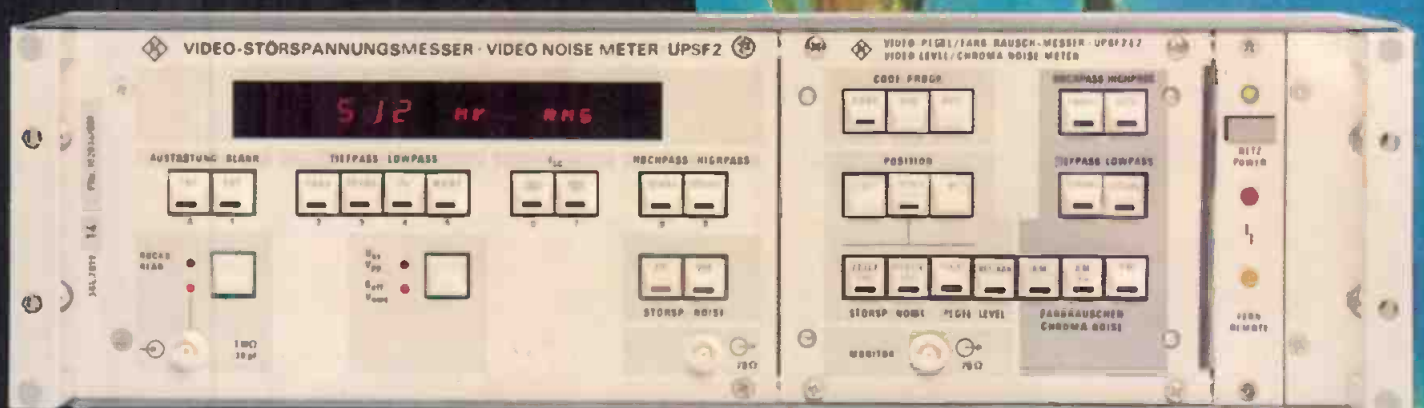

- **DUAL-STANDARD:** μ P automatically determines standard (525/625 lines), identifies it on the display, and performs the appropriate measurement.

- **Measurement Domain:** Full-field, any individually selected line, any individual "spot" ($4 \mu\text{s} \times 10$ lines)

- IEEE-488 (GPIB) Bus Compatible

- **Video Level Measurement:** Luminance-bar amplitude, or individual test-points selectable in steps of $1 \mu\text{s}$ (range: -500 to +1500 mV)

- **Noise Measurement:** Luminance (peak or rms) or Chrominance (AM or ϕ M). Range: 0-80 dB, referenced to 714 mV (525 lines), 700 mV (625 lines), or actual luminance-bar amplitude.



ROHDE & SCHWARZ

14 Gloria Lane, Fairfield, N.J. 07006 • (201) 575-0750 • Telex 133310

Circle 170 on Reader Service Card

transform the unit into a framestore synchronizer. Current price for the two-channel system is \$15,000.

For-A, too, demonstrated a new digital TBC—Model FA-410, priced at \$9000, with an optional dropout compensator an additional \$900. Designed for heterodyne signals, it can operate with either V-locked or non-locked VCRs and provides a 16-line correction window.

Other digital products were also in evidence. Oki featured its LT-1200 portable standards converter, but also demonstrated newer, high-resolution systems, presumably a competitor for



For-A had a line of processing gear.

the MCI/Quantel digital standards converter.

A new digital video system that provides simultaneous transmission of two video signals on a single conventional video channel was shown by NEC. Known as the DV-10, the unit doubles video capacity by using a horizontal signal compressing technique, which avoids flicker.

Digital video multiprocessors offering both signal correction and color correction within single units were demonstrated by both Sony and Thomson-CSF (the Model 9100).

Some new color correction systems

were on display, including a unit from For-A. In addition to complete manual control over the various signal parameters, For-A's system can be coupled with a **Relecon** controller from **Applied Digital Technology**; the controller permits complete remote control of the color corrector, including time code addressing for scene-by-scene correction. Relecon was also featured interfaced with the Thomson-CSF color corrector.

Corporate Communications, one of the best-known manufacturers of color correctors especially designed for telecines, had systems for the new Marconi solid-state unit on hand to supplement existing models for Rank and Bosch Fernseh units. "The System" works with either encoded or RGB signals and can cue color changes based on both control track pulse counting or SMPTE time code.

Dubner Computer also demonstrated its microprocessor-based color correction system, introduced earlier.

For more information: Microtime S-130, 595; Quantel digital audio delay, 596; Harris Video Systems HVS-690, 597; Digital Video Systems Phaser VI, 598; Fortel Digibloc, 599; Toshiba VS-IV, 600; ADDA AC-20, 601; For-A Model FA-410, 602; NEC DV-10, 603; For-A/Applied Digital Relecon color corrector, 604; Corporate Communications "The System", 605.

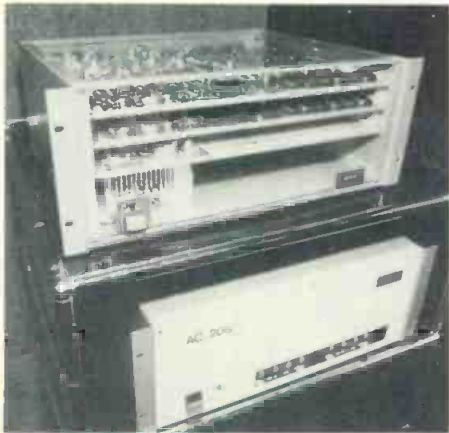

ADDA's AC 20S TBC.



Lake Systems/Control Video

**A Compact,
Expandable,
Video Cart
System that
You Can
Afford.**

LA-KART™
SERIES ONE BY LAKE

Under \$90,000.
Leasing Plans Available

Contact: Lake Systems Corporation, 55 Chapel Street, Newton, MA 02160 (617) 244-6881 TWX 710 335 1639

Circle 171 on Reader Service Card

If you want Plumbicon^{*} picture quality from your next TV camera buy— insist on Plumbicon tubes, because...

...if it's a professional TV color camera—it's available with Plumbicon tubes.

When you're paying top dollar for a professional TV camera, it is assumed by the manufacturer of the camera that you will specify the pickup tubes for your system. Obviously, the camera manufacturer wants to sell you *his* camera, and since he knows that the overwhelming majority of knowledgeable video purchasers will specify Plumbicon tubes, virtually every professional TV camera system produced for today's market is designed to use the Plumbicon tube.

The crucial factors of sensitivity, resolution and burn-in that affect the "total in-system performance" of ENG and EFP cameras and the consistent record of singularly brilliant performance of the one-inch and the 30mm Plumbicon tubes in studio cameras are generally credited for the professional's continued preference for Plumbicon tube-equipped cameras; that is why an estimated ninety percent of all network color broadcasting originates in Plumbicon pickup tubes.

Whatever your application—ENG, EFP or Studio; whatever the origin of your next camera—American-made or imported; and regardless of the camera salesman's personal persuasion (or his own compensation scheme)—you will get Plumbicon quality pictures only by specifying, insisting, demanding Plumbicon tubes in your camera.

Yours for the specifying, the full line of Plumbicon tubes— $\frac{1}{2}$ ", $\frac{2}{3}$ ", 1" and 30mm diameters, including low capacitance Diode Gun™ and special anti-comet-tail types—is available in the professional TV camera of your choice and is in demand today as never before by camera users in every segment of broadcast and corporate television.

There is only one Plumbicon, and that famous Emmy-award-winning pickup tube is available for the asking in every three-tube professional TV color camera sold today. For more information, contact: Amperex Electronic Corporation, Slatersville Division, Slatersville, Rhode Island 02876. Telephone: 401-762-3800.

Amperex[®]

... dedicated to product excellence
A NORTH AMERICAN PHILIPS COMPANY



^{*}Registered trademark of
N.V. Philips of the Netherlands.

Circle 172 on Reader Service Card

www.americanradiohistory.com

Pulse and sync

An interesting note from this year's show is the entry into the signal pulse and processing field by **Grumman Aerospace Corp.** Grumman showed the **Sync Proc**, a combination sync generator/processing amplifier for a sc/h sync-timed facility.

At the McCurdy booth, **AVL Digital** displayed the **VCA-2** clamping amplifier which equalizes frequency response loss caused by cable length. It uses sync tip clamping without affecting the reference burst.

A new black burst timing module, the **PBT 342** from **Lenco**, was introduced to enhance the company's 300 System video and pulse distribution generator. The 300 System is designed to control all pulse signals except vertical drive. Also new from **Lenco** was the **PGL 413** self-contained genlock unit.

Grass Valley had at least nine pulse and sync units including video processing amps, sync pulse generators, isophasing systems, and linearity correctors. The Model 3252A NTSC master sync pulse generator and the 3240/41 remote control unit with optional fade to black lever were also on hand.

Leitch Video showed three types of synchronizing pulse generators. Source synchronizers and phase monitors were also on hand, as were the digital test generator and calibration test generator.

Sigma Electronics introduced a new **BBG-550** module which can advance or delay horizontal sync phase as well as provide 360 degrees of subcarrier adjustment. **Allen Avionics** displayed its full line of precision **L-C filters** and pulse delay lines. Included were delay and video equalizers, laboratory delay lines and precision delay lines.

Bosch Fernseh demonstrated its line of distribution and switching systems, including plug-in cards and processors. The featured new item was the **RKX** video distribution system with RS-422 serial data control. **Composite Video** showed its processing center with image enhancer and black burst generator.

At the **Di-Tech** booth was the full line of pulse distribution amplifiers and

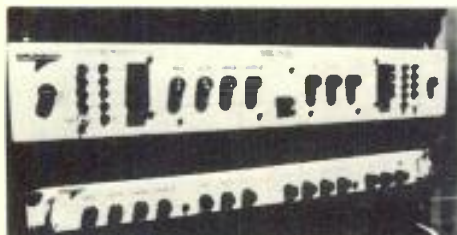

Grumman's Sync Proc.



DA equipment from Leitch Video.

a wide range of video detectors along with the routing switcher line.

New from **Ikegami** was the modular TV signal distribution amplifier system. The **VTN-110A** is a 19-inch rack mount unit which can accommodate up to 10 operational plug-in modules.

Dynair featured the **FR-5300A** module mounting frame for video distribution and EQ systems, and the 1x4 video distribution amplifier with optional desk mount. Equalizing amplifiers and 6x1 passive video switchers were also on display.

HEDCO showed the **SCA-105** low distortion subcarrier and phase control. The **EDA-102** and **VDA-100** have plug-in four-pole cable submodules which allow four individual peaking circuits to compensate for different cable types. The **SDA-107** provides output sync and 4 V p-p levels with 120 ns sin transitions from video input.

Three types of **Matthey video delay lines** were shown by **Television Equipment Associates**.

For more information: Grumman Sync Proc, 606; AVL Digital VCA-2, 607; Lenco PBT 342, 608; Lenco PGL 413, 609; Sigma Electronics BBG-550, 610; Bosch Fernseh RXX, 611; Ikegami VTN-110A, 612; Dynair FR-5300A, 613; HEDCO SCA-105, 614.

Routing switchers

Major developments have been taking place in routing switchers recently, partially based on the need to handle more and more signal sources and partly on the ability of large matrix sys-

tems to be placed under control.

One brand new **e-TransPath** system from **Leitch** for radio, video, audio-follow and audio breakaway modes are available in an extremely compact 400 x 600 expandable matrix. Secret of the system is a telco-like matrix which has special circuitry to prevent "busy" callups. Control options include a CRT-based master controller which can address each crosspoint individually or in groups.

New numeric and alphanumeric control panels were shown for the **Di-Tech 5840 Series** switchers. The 40 x 1 basic crosspoint modules can be configured with video and up to three audio channels per input with audio breakaway for each. Output switching occurs during the vertical interval, making the system suitable for on-air switching.

An offshoot from McCurdy Radio, **AVL Digital** unveiled its new **AVS-1** microprocessor-based routing switcher, designed to offer workers such as test engineers a completely reliable signal source. Basic configurations include 10 x 10 and 20 x 20, with a full range of video, audio, AFV, and breakaway modes.



Di-Tech's new switcher control panel.

Utah Scientific is continuing to expand the control options for its **AVS-1** single coax party line-controlled switcher. Newest member of the control panel family is the **CSP-1604** featuring 1600 name/number source identification and four-character status and preset displays. The new panel controls a single bus, with four separate presets, accessible with single keystrokes on the keyboard for rapid switching between signal sources.

Brand new from **Grass Valley** was the **Ten-X 10 x 1** utility routing switcher, which takes only one rack unit of space. Video only, AFV, and audio breakaway modes are available. **Grass Valley** also demonstrated new **multi-bus control panels** for its 440 Series routing switchers. All panels provide continuous readout of the status of the bus being controlled using either numeric sequences or alphanumeric keys

We wrote the book on Time Code.



Time Code Pioneers. Before we wrote The Time Code Book, we helped establish SMPTE Time Code standards and engineered the first SMPTE Time Code Generators and Readers. The first to make SMPTE Code really work, our leadership has been recognized and awarded.

Innovation, A Way Of Life. Now, we've introduced the first microprocessor-based equipment enabling you to utilize Vertical Interval Time Code (VITC). Because it's one thing to earn a reputation, it's another to maintain it.

And again, we're contributing to a standard. Further participation with SMPTE helped establish a proposed recommended practice for VITC, and our equipment is designed to make the most of its capabilities. With VITC every field/frame is identified and the code is in the video picture, permitting you to read the code in still frame while freeing the audio track normally used for time code.

At Technology's Leading Edge. Like all EECO Video Products, our VITC Generators and

And now it's yours free.

Readers are innovated for performance, providing quality, reliability and precision at competitive prices. And our Readers allow you to extract VITC at wind speeds.

15 Years Of Industry Involvement. Supported and serviced by our factory, EECO Video Products are distributed worldwide by Ampex Corporation and in the Southwest by Hoffman Video Systems.

Ask For Our Free Time Code Booklet. For the whole time code picture—Serial and VITC—ask for The Time Code Book, from the people who wrote the book. Write or call. EECO Incorporated, 1601 East Chestnut Ave., P.O. Box 659, Santa Ana, CA 92702-0659. Phone: 714/835-6000.

EECO
Incorporated

Circle 173 on Reader Service Card

ASACA/ Shibasoku's CMM Series monitors decode color on the I/Q axis.

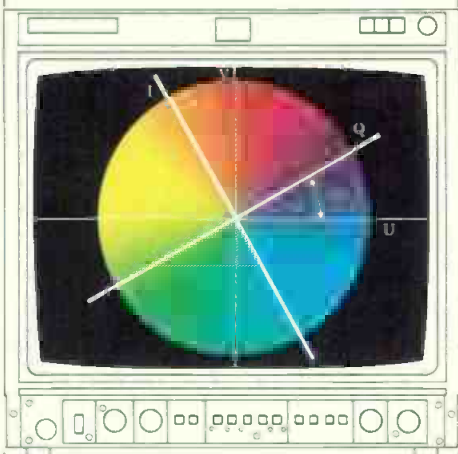

FEATURES

- 20" and 14" models available—high resolution delta CRTs.
- I-Q wide band demodulation system.
- Complete board interchangeability between models.
- Switchable high performance comb filter and aperture correction.
- Multi-standard capabilities (NTSC, PAL, SECAM) on all models. Switchable from the front panel (20" model). No adjustments necessary because of digital sync circuitry.
- Dynamic focus insures perfect focus on all areas of CRT. Adjustable from the front panel.
- Special feedback circuits guard against color changes due to variations in temperature.
- Active convergence—40 controls allow precise adjustment on all areas of CRT.
- Pulse cross with expanded vertical blanking interval.
- OPTIONS... Built-in color bar or cross hatch patterns. Built-in safe title marker generator. Multi-standards. RGB inputs.
- TWO YEAR WARRANTY ON ALL PARTS AND LABOR INCLUDING THE CRT.

ASACA
ASACA/SHIBASOKU
CORP. OF AMERICA

12509 Beatrice St.
Los Angeles, CA 90066

Circle 174 on Reader Service Card

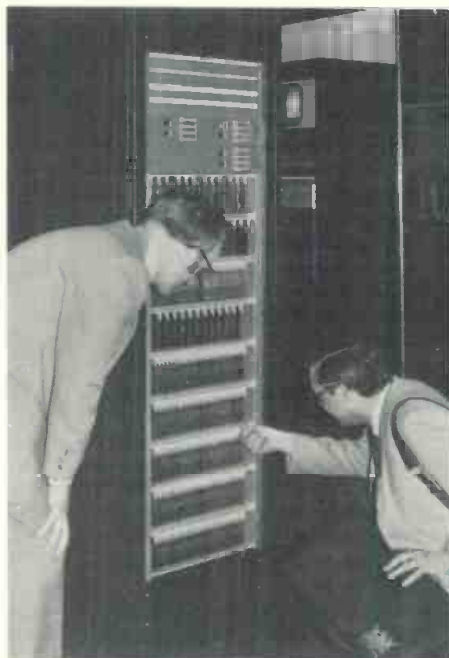

AVL Digital's AVS-1 routing switcher.

for sources such as cameras, VTRs, and switchers.

Featured by **Datatek** was a three-level CRT-based control system for its D-2000 Series routing switchers (50 x 25 basic module size). The device has both an "auto" mode in which it sequences through the status of the entire system bus by bus, or a manual display in which the operator holds on a particular part of the system. The display is cross-referenced for both assignment numbers and names, providing an electronic lookup table. Maximum switcher size is 250 x 250.

Computer control was also demonstrated for **Telemet's Model 7934** routing switcher, connecting a switcher up to 400 x 400 through five-pin connectors. Four-level video, two audio, and time code distribution are featured.

Image Video has come out with a new, modular routing switcher which can be configured up to 256 x 256 maximum with any combination of video, audio, and time code matrices. All controls are microprocessor-based, with

coax cable connections. Balanced audio is maintained throughout, both with AFV and breakaway operation.

Vital continued to demonstrate the **VRS-304** switcher, configurable to 30 x 200 maximum. Two video and audio outputs per bus are provided. NEC had its **digital routing switcher**.

Also continuing to demonstrate its video and audio routing switchers was **Bosch Fernseh**, whose **TVS/TAS-1000** can contain up to 1000 cross-points in an 8.75-inch chassis. Single party line coax control is offered with a variety of alphanumeric control panels.

Dynair, in a major product display, featured its **System 21** matrix routing switcher, again a microprocessor-controlled system capable of being configured up to 1000 x 1000 and carrying video, audio, time code, tally, and now, for the first time, digital data signals. Conforming to new SMPTE serial data control interfaces, the system's 35 MHz bandwidth could accommodate HDTV signals. A CRT-based master controller shows both the status of all crosspoints and also executes commands—including time code activated cues. A full range of other X/Y control panels is offered.

Finally, not to be forgotten are the much-used **3M** routing switcher systems in 15X and 20X series, capable of being operated with the 6500 microprocessor control system. New this year was an **alphanumeric control panel** which can access 15 different types of equipment with 99 individual units per category. The panel can be used as a single-bus, multi-bus, or full matrix controller and allows presetting of both video and audio sources and a "take preset" button.

For more information: HEDCO *TransPath*, 615; Di-Tech control panels, 616; AVL Digital *AVS-1*, 617; Utah Scientific *CSP-1604*, 618; Grass Valley *Ten-X*, 619; Grass Valley *multibus control panels*, 620; Datatek control system, 621; Telemet Model 7934, 622; Image Video routing switcher, 623; Dynair System 21, 624; 3M alphanumeric control panel, 625.

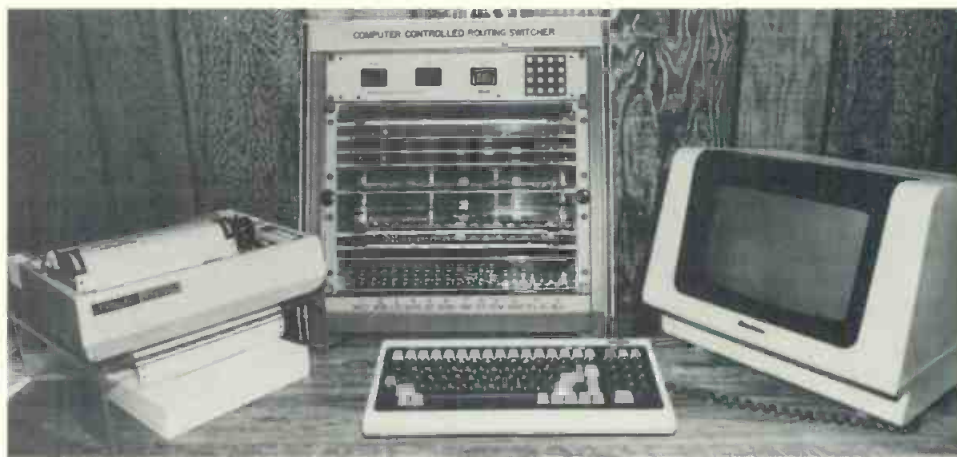

Telemet's 7934 routing switcher.

BROADCAST PRECISION

Introducing the Ampex ATR-800. More features than ever before in a broadcast audio recorder.

In a busy broadcast environment, every minute counts. That's why Ampex designed the ATR-800 with saving time in mind. With more standard features than any other recorder in its class, the ATR-800 is the perfect choice for broadcast professionals. And recording studio engineers? Take note.

The ATR-800 was designed for tape editing. The wide open head assembly gives you fast, accurate tape access. Recessed head gate and transport controls prevent tape snag. And a continuously variable shuttle, under control of the microprocessor, regulates tape speed and direction.

But the features don't stop there. You'll find a standard cue amplifier that allows monitoring of any or all channels, a quick change head assembly, a digital tape timer with single-point search-to-cue, three tape speeds

with built-in vari-speed, fader start for remote control from a console and much, much more. All standard. And with a switchable NAB/IEC setup, the ATR-800 is a true international recorder in every sense of the word.

Look around, no other audio recorder offers you more standard features than the ATR-800. Whether you need rack mount, console or pedestal versions, call your Ampex dealer or write Ampex Corporation, Audio-Video Systems Division, 401 Broadway, Redwood City, CA 94063 (415) 367-2011. Sales, spares and service worldwide.

AMPEX TOOLS FOR TOMORROW

Ampex Corporation • One of The Signal Companies 

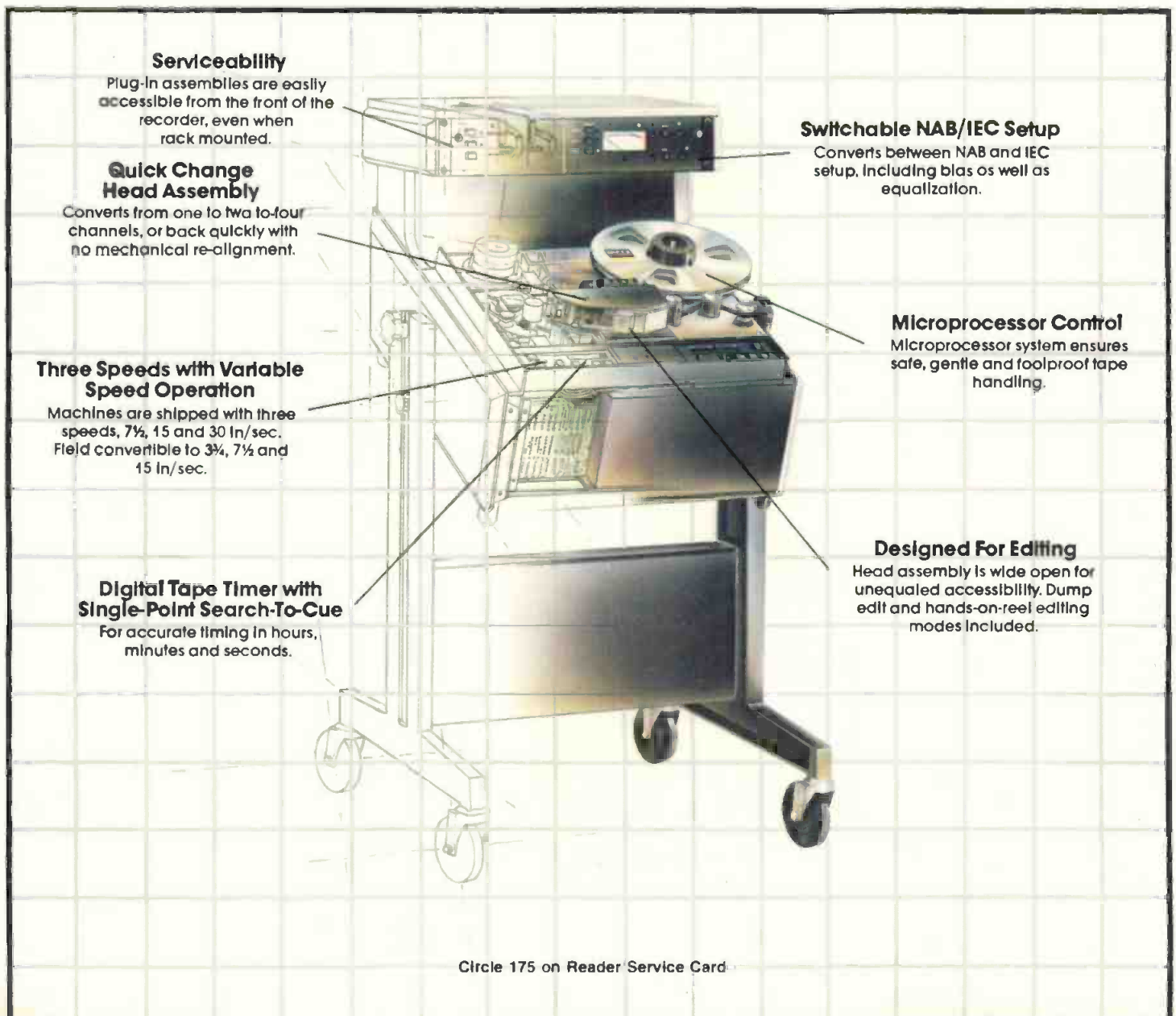

Serviceability
Plug-in assemblies are easily accessible from the front of the recorder, even when rack mounted.

Quick Change Head Assembly
Converts from one to two to four channels, or back quickly with no mechanical re-alignment.

Three Speeds with Variable Speed Operation
Machines are shipped with three speeds, 7½, 15 and 30 in/sec. Field convertible to 3¾, 7½ and 15 in/sec.

Digital Tape Timer with Single-Point Search-To-Cue
For accurate timing in hours, minutes and seconds.

Switchable NAB/IEC Setup
Converts between NAB and IEC setup, including bias as well as equalization.

Microprocessor Control
Microprocessor system ensures safe, gentle and foolproof tape handling.

Designed For Editing
Head assembly is wide open for unequalled accessibility. Dump edit and hands-on-reel editing modes included.

Circle 175 on Reader Service Card

GAIN VIDEOCONFIDENCE!TM

NEW JVC CR-4700U

PORTABLE 3/4" U TAPEHANDLER



© 1982 US JVC CORP.

Here's something really new in a portable 3/4" U videocassette recorder: JVC's exclusive VideoConfidence™ head. Now you can be absolutely confident that you're getting on tape what you see in the camera monitor...because you review as you record!

The picture you see in the monitor

is fed to it from the tape a split second after recording. What you get is what you see.

There's no other portable 3/4" U VCR with this feature.

But that's not all the CR-4700U offers. It has SMPTE time code capability to speed post-production editing. Head switching is in the vertical interval to eliminate undesirable switching points. There's microprocessor-based logic for full remote control. You can do assemble editing in the field with the automatic editing function.

And how about a video S/N ratio of better than 46dB! No other portable 3/4" U VCR has so many valuable features.

See it NOW at your JVC dealer.

For more information write
 US JVC CORP., Dept. BM/E 6/82,
 41 Slater Drive, Elmwood Park, NJ 07407.
 JVC CANADA, INC., Scarborough, Ont.

For faster action, call toll-free
800-821-7700, Ext. 7005
 (In Missouri: 800-892-7655, Ext. 7005.)

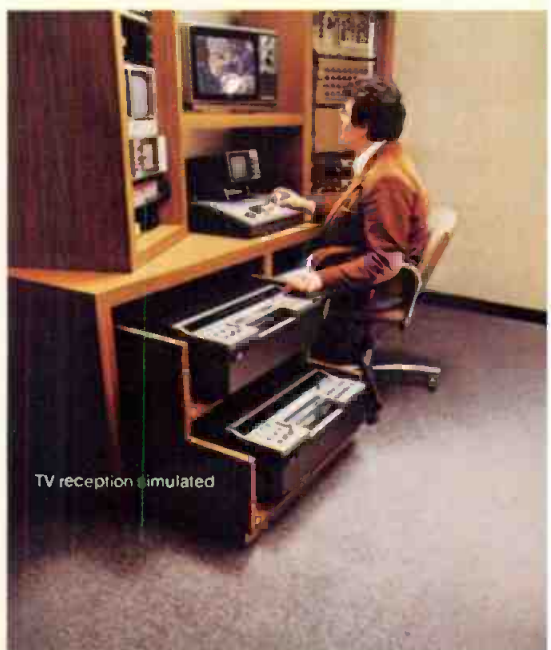

Circle 176 on Reader Service Card

www.americanradiohistory.com

Test and measurement

Just as advanced semiconductor technology has brought increased sophistication to video equipment, so has it affected the performance, size, and cost of the gear used to test video systems. Because of these changes, there is more test equipment available that will go with broadcasters into the field as the ENG/EFP trend intensifies.

For compact size at an appealing price, the **Tektronix Portable 380 NTSC** test monitor was one of the hits at NAB. Built by joint-venture company Sony/Tektronix in Japan, the 380 is a three-in-one portable incorporating the functions of a waveform monitor, vectorscope, and an oscilloscope in a unit measuring 4.48 x 9.48 x 14.88 inches. It weighs 12.1 lbs., costs \$5150 and has a battery pack priced at \$800.

Tektronix also returned with its **ANSWER** microprocessor-based VITS analyzer, now enhanced with a new software package called Option 3 for transmitter monitoring. The new software will monitor and measure signals in any cycle determined by the engineer.

While Tek has elected to use one



Portable 380 scope from Tektronix.

display screen for its combination, Videotek and Leader Instruments have designed separate but compact units so that a waveform monitor and a vectorscope can fit side by side in a standard rack.

Videotek's units for color TV monitoring are the **TSM-5A** Waveform Monitor priced at \$1965 and the **VSM-5A** Vectorscope priced at \$2365. **Leader** added the **LBO-5860** "half-rack" waveform monitor to the recently introduced vectorscope, Model **LVS-5850**. The unit can blank the

vectorscope during the active portion of the video signals so that the VITS can also be displayed vectorially.

Electronic Visuals Ltd. through its North American distributor Broadcast Video Systems, has a one-display, switchable color signal monitor. Model **EV4060** operates in waveform mode and vector mode and is half-rack size. Price is \$4100.

Hitachi too added the **VO 89 NTSC** vectorscope to match its **VO 99** waveform monitor and form a combination unit. The vectorscope is priced at \$500 and is due for fall delivery. Hitachi also showed its **V209 2 MHz** dual trace mini portable oscilloscope and the **V1050 100 MHz** quad trace calibrated sweep delay scope.

Notable products from the **Lenco** booth included the **PVS-430 Videoscope** designed to provide images of the subcarrier-to-horizontal sync specifications outlined in RS-170A(SC/H). Initially, the Videoscope is set up to select one of the video sources in the system as the system reference. If not correct, the source is adjusted until it meets standard and becomes the reference to which all other sources are compared.

Among the wall-full of instruments displayed by **Asaca/Shibasoku** was the

THE 6112 IS BY FAR THE MOST ADVANCED SWITCHER IN ITS CLASS. NOTHING ELSE EVEN COMES CLOSE

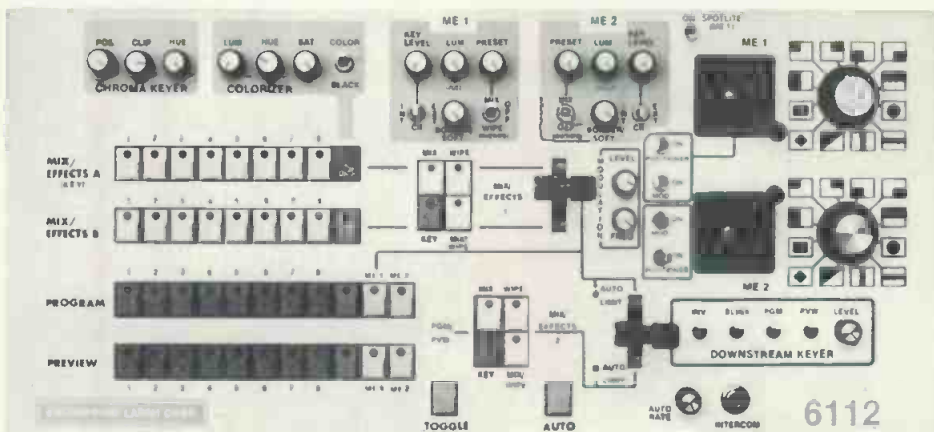

DIRECT OPERATION FROM EDITOR KEYBOARD

With the model **6403**, the **6112** is directly plug compatible with many editors. No modification to switcher or editor is required.

Under **6403** control the **6112** accepts commands such as duration times, pattern type, bus selection etc., directly from the editor keyboard. The **6403** also provides additional capability of accurate start and finish, size and position of pattern transitions.

Audio follow or split audio capability is provided by the **6800** mixer which has separate level controls for each stereo input. The **6803** can be driven either directly by the editor or via the **6403** interface unit.

- TREMENDOUS PRODUCTION CAPABILITY
- EASE OF OPERATION
- TWO FULLY INDEPENDENT MIX-EFFECTS SYSTEMS
- AUTOMATIC MIX AND WIPE
- DUAL BACK PORCH CLAMPS
- ROCK STABLE CIRCUITRY
- DOWNSTREAM KEYS
- TWO ADDITIONAL KEYS

MODEL 6112 NTSC \$7950. PAL \$8950.

Chroma Keyers Encoded or RGB \$1050. (Encoded chroma keyer not available in PAL)

DELIVERY WITHIN TWO WEEKS.

CROSSPOINT LATCH CORP.

CROSSPOINT LATCH has the largest selection of compact switchers and switcher products to choose from. Write on your letterhead for our Post-Production Booklet.

95 Progress St. Union, N.J. 07083
(201) 688-1510 Telex: 181160



NTI's 535 signal generator.

CB53A1 color bar signal generator, which has a built-in character generator and keyboard for inserting information with the bars.

Marconi Instruments, at the Marconi/A.F. Associates booth, brought updated versions of some of its T&M gear. The Model 2914A TV insertion signal analyzer had new interfaces for automatic operation using instrument controllers. Also on display was a revised 2920 TV interval timer.

Power-Optics displayed test gear

from Grafikon. Equipment on view included an **electronic color analyzer** that transfers color temperature readings from a master to other monitors, an optical color comparator for setting color temperature at all luminance levels, and a TV light meter.

NTI returned to NAB with its Model 535 digital color monoscope signal generator, familiar to attendees of previous shows.

For its part, Rohde & Schwarz made note of its Video Noise Meter

UPSF-2. Boasting microprocessor control, the unit features fully automatic selections for 525 and 625 line systems, digital readout of true rms, and free choice of test point. Noise measurement is luminance (peak or rms) or chrominance. Range is 0-80 dB, referenced to 714 mV or actual luminance-bar amplitude.

Another T&M booth heavy with new products was QSI. Two interesting items were the **Valid Video Identifier System** and the **VT-7 Video Leader Countdown Generator**. The former encodes and decodes up to eight characters of ASCII information into the vertical blanking period for use in identifying cameras in multi-camera shoots.

A similar countdown generator/video stateboard is available from BEI.

Other instruments of note included TV demodulators from QSI, Rohde & Schwarz, Videotek, and Barco for both UHF and VHF bands as well as CATV applications.

Porta-Pattern had its line of test charts, and black and white chess board aspect ratio transfer alignment film for telecine applications. Price of the transfer alignment film (100 ft.) #005-20 is \$395 and delivery is in 30 days.

Amtron showed its AG341 safe

PACKAGE DEAL

Anchor 100 & 200

Direct coupled Amp/preAmp with 35 or 55 watts of power.

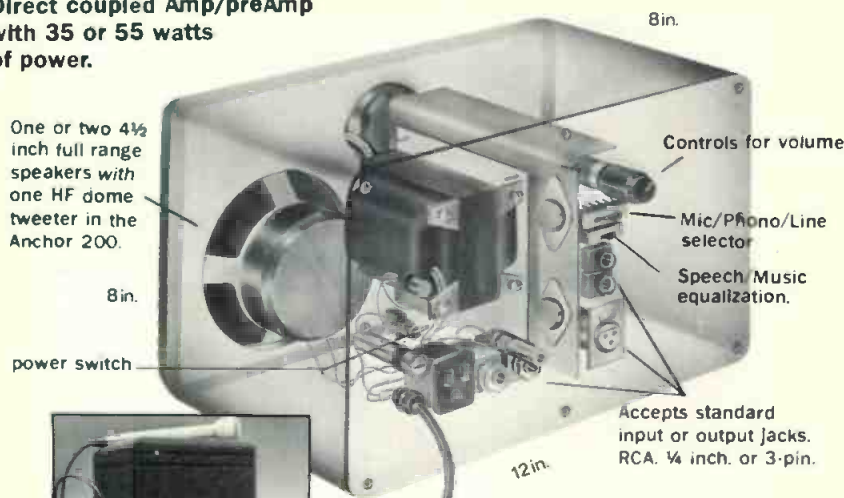

Anchor 100: 11 lbs.
Anchor 200: 14 lbs.
Awesome sound in a high tech package.

ANCHOR 
Hearing is believing.

4510 FEDERAL BLVD., SAN DIEGO, CA 92102
(714) 262-9901

Circle 178 on Reader Service Card

swintek

The Leading Name In Cordless Microphone Systems



Transmitters small enough to be hidden almost anywhere, tiny microphones that are so unobtrusive that they probably won't even be noticed, hand-held microphones without the encumbrances of hundreds of feet of wire — that's what cordless microphone systems are all about. But there's one more factor of prime importance — reliability. If you're in television, radio or film and you want a cordless microphone system that not only offers the most advanced state-of-the-art electronics but the highest reliability rating in the industry, Swintek is the answer. There's a Swintek transmitter and receiver to fit your specific needs, no matter what your requirements. Check with us today about the greatest name in cordless microphone systems — Swintek.

alan gordon enterprises inc.

1430 N. Cahuenga Blvd., Hollywood, CA 90028
Telephone: (213) 466-3561 • (213) 985-5500
TWX: 910-321-4526 • Cable: GORDENT

Circle 179 on Reader Service Card

SHOK-STOP, The case that covers the Super Bowl and never drops the ball.



Slam. Bang. Crunch.
No wonder fumbles happen on the field.

The real wonder is that Shok-Stop cases can take the same kind of punishment on the way to the field—and still protect your sensitive broadcast equipment.

It's because our case design incorporates "concertina" folds which absorb shock energy by "giving" slightly during impact.

And the outer material is a tough but resilient polyethylene that

returns to its original shape to await the next jolt.

Inside, cushiony foam adds yet another layer of protection. With 98 "blank foam" cases and hundreds of custom patterns, we can transport virtually any piece of broadcast equipment with snug assurance.

What's more, only Shok-Stop latches, handles and hinges can easily be repaired in the field. Because something as important as a Super Bowl broadcast shouldn't hinge on a hinge.

With water-tight Shok-Stop cases on your team, you'll sleep better the night before the big game.

So call today for full information.
Thermodyne International, Ltd.
20850 S. Alameda, Long Beach,
CA 90810. (213) 603-1976

**T THERMODYNE
INTERNATIONAL LTD**
Superiority in every case.

Circle 180 on Reader Service Card

www.americanradiohistory.com



Video noise meter from R&S.

area/safe title display generator. This instrument turns a video monitor into a precision alignment instrument to verify timing and confirm transmission of vital picture information. It has an optional remote control box. Price is \$2095 with remote option.

Other instruments included Auburn Instruments' DBM-1 Digital Planking Interval Meter priced at \$995; Image Video's 8105 Border Generator tagged at \$4500; VG Electronics' Zone Plate Generator VGE 1032 to test frequency response of H,V, and Temporal dimensions simultaneously; Cox Electronics' 399 Color Balance Corrector priced at \$6400; and Tentel's VTR tape tension and spindle height gauges.

For more information: Tektronix 380 NTSC, 626; Tektronix ANSWER, 627; Videotek TSM, VSM, 628; Leader LBO-5860, 629; Electronic Visuals Model EV4060; 630; Hitachi VO89 NTSC, 631; Lenco PVS-430 Videoscope, 632; Asaca/Shibasoku CB53A1, 633; Marconi Instruments Model 2914A, 634; Marconi 2920 TV interval timer, 635; Power-Optics electronic color analyzer, 636; NTI Model 535, 637; Rohde & Schwarz Video Noise Meter, 638; QSI Valid Video Identifier System 639; QSI VT-7 Video Leader Countdown Generator, 640; Amtron AG341, 641.

Monitors

High resolution color monitors continue to appear, in part because of the increased popularity of computer color graphics. This year's NAB saw introductions of both RGB and NTSC monitors.

An intriguing aspirant in this competition was the computer-type RGB monitor testing the waters in the Conrac booth. This is a hot product in computer graphics and computer-aided design applications, and Conrac rolled it into NAB to see how broadcasters would respond. Although the Model 7211 does not even appear in Conrac's literature yet, it could have major impact with its 40 MHz bandwidth and 37 KHz sweep frequency. Reason: the high production volumes of this unit in the computer market will drive the price down, despite the relatively low volume demand in broadcast applications. Conrac also showed newly avail-

able units in the 6100 Series, 5700 Series, 5300 Series, and 5200 Series.

Other high resolution monitors were in abundance. Ikegami unveiled the new Series 9 of low-cost 14- and 20-inch units featuring in-line gun, self-converging shadow mask picture tubes with matched phosphors and quoting 600 TV line resolution. They have switchable comb filters as well.

Designed for applications that require switching between digital RGB signals/computer inputs and composite video signals, the Videotek VM-19 and VM-25 19- and 25-inch monitors featured comb filter, switchable underscan, A/B inputs, external sync input and a blue gun only switch. Prices are \$1425 and \$2425 respectively, with immediate delivery.

Among the Sony introductions was the BVM-1900 broadcast color monitor boasting 900 TV lines center resolution at 30 foot lamberts. Also having a comb filter decoder that preserves full luminance bandwidth to 10 MHz \pm 1 dB, the 1900 has a built-in crosshatch generator.



Conrac displayed several new monitors.

Barco's monitors appearing in the Elector booth were a 12-inch unit with 0.43 mm pitch and a 19-inch unit with 0.47 mm pitch dotted screen. Resolution for the 12-inch is the 520 TV lines, 710 TV lines for the 19-inch. Prices are \$2250 for the former and \$2995 for the latter.

Tektronix introduced two options to the 690SR color picture monitor introduced a year ago. The 690SR Option 02 includes a 69M01 comb filter decoder. This unit features a choice of either the comb filter or a phase-linear notch filter, selectable from the front panel. The 69M01 NTSC comb filter decoder with the 690SR costs \$9350. The option purchased separately by 690SR owners is \$1400.

Prompted by growing interest in high fidelity sound in TV broadcasting, the Professional Video division of US JVC brought out the C-208UM 19-inch stereo monitor/receiver. The monitor's five-watt amplifier powers two full-range, internal speakers or can be con-

nected to external speakers. It features comb filter, A/B inputs plus eight-pin VTR connector, and sound directed by side baffles. Price is \$950.

Other color monitors were on hand from Asaca, Models CMM20-11 and CMM 14-11, also with comb filters. Sharp showed its XR-3019 19-inch and XR-3013 13-inch monitors for "classroom or the studio."

Monitors in the Lenco lineup centered around the PMM-900 monochrome units with individual replacement modules and 900 lines of resolution. Also on display was the PMM-399 four-inch engineering video monitor for video signal evaluation. Loop-through video, pulse cross, and underscan are standard in the PMM-399.

For more information: Conrac Model 7211, 642; Ikegami Series 9, 643; Videotek VM-19, 25, 644; Sony BVM-1900, 645; Tektronix 690SR Option 02, 646; JVC C-208UM, 647; Asaca Model CMM20-11, 14-11, 648; Sharp XR-3019, 3013, 649; Lenco PMM-900, 399, 650.

Lighting, sets

Among the new lighting control developments in Dallas was Colortran's microprocessor-based Colortrack, which controls 125 dimmer channels and features a color-coded CRT display coordinated with the operator's control keyboard. The system will store over 200 memory cues for each channel. The company also showed Channel Track II, an updated version of its Channel Track lighting control System.

Kliegl introduced its Entertainer portable memory lighting control console for proportional patching of dimmers to up to 48 group masters. Shown for the first time was the K96 digital dimmer system.

Dynamic Technology Ltd. introduced its latest memory lighting control system, the Datalite 192, which controls up to 192 channels and offers optional pin patch, trick effects facility, studio remote control, and mimic display.



Kliegl's portable Entertainer.



No surprises.

© 1981 Fuji Photo Film U.S.A., Inc., Magnetic Tape Division, 350 Fifth Avenue, N.Y. NY 10118

Available in 2", 1", 3/4" and 1/2" Beta and VHS.



Circle 181 on Reader Service Card

New to the NAB was the Wizard computerized lighting control console from Theatre Techniques. Standard features on this \$20,000 (approximately) unit include 120 channels electronically patched to 512 dimmers; two timed or manual crossfaders; 10 submasters; and floppy disk library storage. The Wizard is distributed by Olesen, which also introduced the 43406 location distribution panel.

The Teatronics Datacue II memory lighting control system made its NAB debut at the booth of its distributor,



Arben Design showed modular sets.

Plan to be at Inter BEE



**1982 International
Broadcast Equipment Exhibition
in Japan.**

The date: November 9 through November 11.
The place: Tokyo Ryutsu Center (TRC)

The attraction: Everyone in Broadcasting in Japan and visitors from other countries will be coming to see and take part in the only event that draws all broadcasters to Tokyo. Broadcasting equipment of the latest design will be exhibited by leading Japanese, American and European manufacturers. So plan now to be at Inter BEE 82.

Sponsor: Electronic Industries Association of Japan
Co-Sponsor: The National Association of Commercial Broadcasters in Japan
NHK (Japan Broadcasting Corporation).
Management: JAPAN ELECTRONICS SHOW ASSOCIATION
No.24 Mori Bldg., 3-23-5, Nishi-Shimbashi, Minato-ku, Tokyo, Japan.

Theatre Vision. The system is capable of storing 260 cues and has full manual backup.

Strand Century had an all-new operating program for its **Lightpalette** console, designed especially for TV production. Also new were a 6 kW six-way **dimmer pack** for the Mantrix control system and the **Pulsar 120 V or 30 V camera light**.

Electro Controls had a new **computer patch** for its dimming system and new features on its **LitePatch** memory system, which allows the same light to be programmed for more than one use.

Osram is now producing HMI lamps ranging all the way from a small 200 W bulb to a giant 6 kW, and this was reflected in new lighting fixtures from several makers.

Arriflex, for example, featured a new 6 kW daylight HMI fixture with a 500 mm shock-mounted fresnel lens and a modular stainless-steel ballast. It weighs 84 lbs. The company was also featuring a 200 W HMI Reporter portable, which operates on battery or ac.

Mole-Richardson also showed a new fixture for the 6 kW lamp. The **Type 6281 Solar-Arc Solarspot** needs no daylight fixtures—"just push a button for daylight," the company says. The light features a 20-inch fresnel lens, a new positive ignition system, and a new ballast with noise-free operation. **Mole** also showed a new 200 W HMI fixture.

On the small end of the scale, **Cinema Products** brought a new entry from Ryudensha, a handheld 200 W HMI news light with a new flicker-free ballast and quick charger. This "Press Kit" operates with either battery or ac power.

Belden introduced the **Lee 200 W HMI portable daylight sungun**. This unit was actually introduced back in 1975, but had been out of production and made its first reappearance at this show. It will operate on battery, four car batteries, or ac, and is flicker-free. **Belden** also showed the Lee line of filters and the **Rainbo Products CX-7 col-**

Circle 182 on Reader Service Card

The next generation in editing systems.

Mach One® Series II.

Mach One from Fernseh has always been the fastest videotape editor on the market. The easiest-to-use.

And because it's software-based, we can make it more powerful with software changes.

That's exactly what we've done with the new Mach One Series II—the second-generation system.

Powerful new features.

Series II has all the features of the original Mach One. Plus six important new features that not only let you edit faster than ever, but give you unique capabilities and conveniences.

Dual-channel audio control. This exclusive feature gives you complete and independent control over two separate audio tracks in addition to the video channel.

Variable speed control. You can select any of 16 shuttle-jog speeds in either direction—all the way from freeze frame to maximum VTR speed.

Programmable slow motion.

Once you've selected a speed, it's displayed on the screen and you can program it in the edit list (for example, "half-speed at two minutes in, three-quarter-speed at three minutes in," and so forth). The programmed sequence is then completely repeatable.

Updated edit list formatting.

Mach One Series II gives you 6-digit alphanumeric reel numbers, audio channel 1 and 2 entry, additional events displayed on the screen, and other edit list features.

Cluster-event programming.

A Mach One exclusive. This powerful feature lets you program extremely complicated multiple events, known as "elements," in a "cluster" and treat them as a single event. For example, a complex series of switcher wipes, dissolves, or keys—together with digital video effects—can be quickly put together and previewed or recorded *in one pass* rather than event-at-a-time.

Screen highlighting. We've made the Series II edit screen easier to work with. Now it brightens the edit line you're working on and simultaneously dims the rest of the screen. It's easy

on the eyes, easy on the nerves, and never lets you lose your place—even for a second.

The editor's editor.

Mach One Series II in your editing room will give you speed and ease of operation that translates into creativity and profits.

You need the new generation in computer-assisted editing for your post production. And the new generation is exclusively Mach One Series II.

Your local Fernseh office is anxious to get you full details. Call them. Or get in touch with us directly: Fernseh Inc., the Video Corporation of Bell & Howell and Robert Bosch, P.O. Box 15068, Salt Lake City, UT 84115. (801) 972-8000.

From now on,
look to Fernseh.

FERNSEH



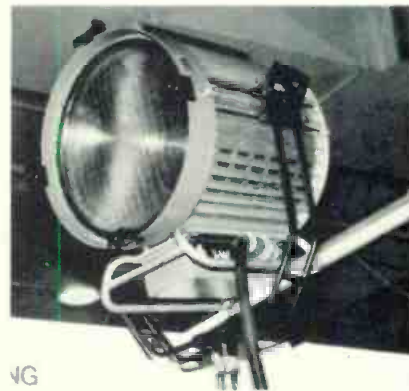

or changer, a presettable auto changing device for lighting filters.

LTM, which also has a range of HMI fixtures, had a unusual introduction: a small fiber optic light designed to illuminate interiors of vehicles or to light products at very close range. It is particularly suited to the latter application since it generates no heat.

Phoebus Manufacturing introduced its new Ultra Quartz follow-spot, a special small model for studio applications. Two more followspots, the Xenon Trouper and Xenon Super Trouper, came from Strong International.

Also introducing a new spot was Lowel-Light, whose 1000 W Lowel DP is an updated version of the Lowel D. The company also unveiled the Softlight 2, successor to the Softlight 1500.

Two new studio variable beam quartz lighting systems from Bogen Photo Corp. were the 600 W Model 7000, and the 650 W Model 7050, each available in a variety of kits.

Comprehensive Video Supply brought a range of brand-new quartz location lighting units, including beam lights and floods, as well as a new light kit from Pag Power. The Pag unit, a highly portable ENG/EFP model, is about six feet tall but collapses to fit into a small case with snap-on cover.

A new portable location lighting kit from Frezzolini, the SPK-1, packages three 650 W portable camera lights, three 120 V ac power cords, three light stands, and a variety of accessories into a compact, fitted carrying case.

Matthews introduced its Video Matth-Pak, a comprehensive selection of location lighting accessories in three sturdy cases that fit into the back of a station wagon. Both Sylvania and General Electric introduced new studio lamps.

The Great American Market brought its Scene Machine lighting effects generator in a new 2K version, giving twice the light of the previous 1K model. The company also displayed its line of Instaset vacuum-formed scenery.



(Top, left to right) New Lowel Softlight 2; 6 kW HMIs from Strand Century and Arriflex. (Below) Black Beauty spot from Anton/Bauer.

Peter Albrecht Corp. described its Sigma Pac memory control system for stage and studio machinery, which it said was an economical way of mechanizing a major studio lighting grid. This system was used extensively in the Dallas Communications Center, a large new Dallas tape and film production facility for which Fiorentino Associates was the consultant.

At its first NAB, Gagnon Laforest displayed its Vertilift mechanized theater rigging system, hoping to impress the TV market.

Uni-Set Corp. brought a new addition to its modular studio staging system, the RTR (riser blocks/tops/ramps) dolly. Priced at \$1675, this set includes a to-scale planning model, riser blocks, tops, ramps, and a storage dolly.

Arben Design, at NAB for the first time, showed its modular set design systems, including the three Lebenset packages, which include a variety of risers, geometric forms, and grid shapes. The company also had a new prefabricated cyclorama.

Walter S. Brewer Co., a joint venture with Electro Controls, introduced an adjustable telescoping hanger for lights or monitors, operated from the studio floor, and a ground row to hide cyclorama floor lights.

Theatre Service & Supply Corp. showed its cycloramas and lighting gear, while Theatrical Services, Inc., described its turnkey lighting and rig-

ging installations (the company specializes in electrical connections).

For more information: Colortran Colortrack, 651; Colortran Channel Track II, 652; Kliegl Entertainer, 653; Kliegl K96, 654; Dynamic Technology Ltd. Datalite 192, 655; Olesen/Theatre Techniques Wizard, 656; Olesen 43406, 657; Theatre Vision Teatronics Datacue II, 658; Strand Century Lightpalette program, 659; Strand Century dimmer pack, 660; Strand Century Pulsar camera light, 661; Electro Controls computer patch, 662; Arriflex 6kW HMI, 663; Mole-Richardson Type 6281 Solar-Arc Solarspot, 664; Mole HMI, 665; Belden Lee sungun, 666; Rainbo CX-7, 667; LTM fiber optic light, 668; Phoebus Manufacturing Ultra Quartz spot, 669; Strong International Xenon Trouper, 670; Lowel-Light Lowel DP, 671; Lowel-Light Softlight 2, 672; Bogen Photo Corp. Model 7000, 7050, 673; Comprehensive Video Supply Pag Power light kit, 674; Comprehensive Video Supply quartz lighting, 675; Frezzolini SPK-1, 676; Matthews Video Matth-Pak, 677; Sylvania/GTE studio lamps, 678; General Electric studio lamps, 679; Great American Market 2K Scene Machine, 680; Great American Market Instaset, 681; Peter Albrecht Corp. Sigma Pac, 682; Gagnon Laforest Vertilift, 683; Uni-Set Corp. RTR dolly, 684; Arben Design Lebenset packages, 685; Walter S. Brewer Co. hanger, ground row, 686.

Power

The major development in power was the introduction of several ac power supplies for ENG/EFP cameras. One of these was Cinema Products' Zip-Pak, which weighs less than 2.5 lbs. and fits cameras that accept the Anton/Bauer Snap-On system. Zip-Pak switches for 115/230 V ac, 50/60 Hz power sources, as did all the new adapters. It is priced at \$575.

Anton/Bauer also had its own ac adapters in two versions, both in the Snap-On configuration. The LPS-3 is a less expensive, linear version that operates in the horizontal position on the camera. The PS-1 is a smaller, more efficient model with a special design to limit RFI and EMI output. The company also unveiled two chargers, the Life Saver fast charger for 12, 12.2, and 14.4 V Snap-On nicad batteries and the Wide Range Micro Charger, which can be plugged into virtually any outlet in the world with no switch necessary. Other new items included the

SMALL WONDER

The MICROTIME S-130 Full Frame Synchronizer



Versatility, simplicity and reliability in one compact chassis. The result of packaging innovation and design excellence. The S-130. Only from Microtime.

- Full Frame storage processes VITS, VIRS, and teletext information
- Selectable auto freeze or auto black with loss of input signal
- Manual selection of Field 1, Field 2, or Full Frame Freeze

- Independent adjustment of horizontal and burst output phase, with respect to black burst reference signal
- Automatic color/mono detection and switching
- Differential video input for common mode hum rejection
- Light weight, small size, and low power consumption make the S-130 ideal for mobile or ENG use

A microprocessor testing subroutine initiated by internal switch selection provides self-testing capability for ease of maintenance and confidence testing.

For full information, contact:
MICROTIME, INC.
1280 Blue Hills Avenue
Bloomfield, CT 06002
Tel. (203) 242-4242.
TWX 710-425-1165

 **MICROTIME**

Circle 184 on Reader Service Card



A SINGLE CONTROL SYSTEM FOR YOUR ENTIRE STATION.

With NETWORK CONTROL SYSTEM™ your station lies at your fingertips. Every function, every piece of information is immediately and easily accessible. NETWORK CONTROL SYSTEM – individual software packages that work together as a powerful integrated whole. And each package stands on its own merits.

NETWORK CONTROL SYSTEM (NCS) gives you consistent operating procedures, a common database throughout your station, and a dedicated field service force. You no longer have to purchase separate systems from different vendors. And you have an immediate link to other stations in your group, your corporate headquarters, and your national rep. NCS offers the best return going on your data processing dollar.

Start with the packages you need most right now and add the rest later.

Or go ahead and put NCS to work for your entire station today.

NCS – the only system designed to fit your future.

BIAS™ FOR TRAFFIC MANAGEMENT.

Over 260 stations nationwide now use BIAS, making it the undisputed leader in the industry. BIAS offers the ultimate sales, traffic, and accounting system for any station, with options for media inventory, accounts payable, and general ledger.

MASTER CONTROL AUTOMATION™.

The industry's first fully-integrated MASTER CONTROL AUTOMATION manages program log from order entry through billing – streamlining your station's entire operation. MCA automatically receives the daily program log and allows operations personnel to automate on-air switching, machine assignments, and delegation interface. And you don't have to be a computer programmer to use it.

BUY LINE™ FOR LOCAL AND NATIONAL SALES.

Generate avails quickly, accurately, and tailored to each client. BUY LINE produces a professional presentation in less time than conventional hand-researched methods. Your sales people are no longer tied to a desk, can spend more time in front of the buyer, create more sales. BUY LINE also means faster, completely confidential communications with your national rep.

FEATURE FILM™ FOR PROGRAMMING.

Manage your film inventory and amortization easily, accurately. FEATURE FILM handles contract purchase, booking request, all financial information, and does more than find you the right film. It keeps you posted on the status of contracts and titles that could make the difference in your station's programming and profits. And talks to you in plain English.

ELECTRONIC MAIL, TOO.

NCS customers are linked to DCC's computer center via satellite and data lines, for instant access to other stations in your group, your corporate headquarters, and national rep, with complete confidentiality.

FINANCIAL MANAGEMENT, WORD PROCESSING AND MORE.

NCS offers you additional financial packages, maintained either entirely in-station or processed through our Memphis computer center. NCS now also offers word processing and electronic filing modules, with a news automation module on the way.

NCS. The station of the future. It's available today. For more information, mail the coupon or call our Broadcast Division Sales Department at (901) 345-3544.

NETWORK CONTROL SYSTEM. The simplest, most efficient way to run a television station.

NAME _____

TITLE _____

STATION _____

PHONE _____

ADDRESS _____

CITY _____ STATE _____ ZIP _____



BROADCAST DIVISION

DATA COMMUNICATIONS CORPORATION
3000 Directors Row
Memphis, TN 38131

Circle 185 on Reader Service Card

Editing starts with CMX

If you think you can't grow from absolute simplicity to total performance look at the world standard for editing.

Editing starts with the CMX 340X because it performs exactly the same simple functions competitors' limited systems do. Two machine cuts editing, for instance, requires the same number of keystrokes. But for you that's only the beginning. The expandability of the 340X will not restrict its simplicity at any point in your growth.



CMX 340X keys are grouped conveniently, color coded, dedicated and easy to reach. That's one reason it's as easy to operate as most limited capacity editors.

Editing never ends with CMX because the 340X is the most expandable and sophisticated editing system in the world. All the new techniques in post-production developed over its five-year history have been added to the earliest 340X systems. The simplicity of the 340X does not

restrict its expandability at any point in your growth.

Editing starts with CMX because every 340X system installation includes basic training in operation and maintenance. CMX has the world's largest staff of editing system specialists to keep you going. These experts are available to install and train you on new features as they become available.

Editing never ends with CMX because our staff editors provide complete 340X training that never stops. This training is supported by advanced seminars, newsletters, an editors' advisory panel, plus worldwide experience in post-production that only the editors at CMX have.

Editing starts with CMX because it did. CMX built the first simple, practical, computer-assisted editing system

over ten years ago. Along with our original customers we



have continued to grow and to lead. While others have come and gone, CMX continues to be the world standard for editing. We have the ten-year track record to support you now

and in the future.

Editing never ends with CMX because your initial investment is protected from absolute simplicity to total performance. Before you invest in post-production, look at the difference in total investment between competitors' limited systems and CMX.

The 340X has replaced many other systems; and every CMX user has stayed with us when he expanded his system. Editing never stops with CMX when editing starts with CMX.

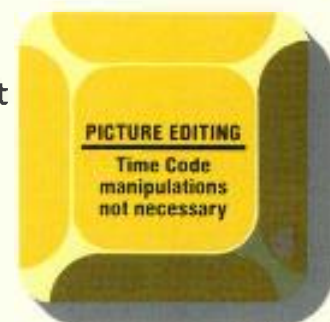

Orrox Corporation 3303 Scott Blvd., Santa Clara, CA 95050 (408) 988-2000 Telex 910-338-0554/Chicago (312) 325-8488/Los Angeles (213) 980-7927/New York (212) 371-1122 International Representatives: Magna Technics, Australia/Totsu, Japan/Sight and Sound, Hong Kong/TeknoMerica, Mexico City/Arvid, Argentina/F.W.O. Bauch, United Kingdom/Thomson, France/GTC, W. Germany/Video Promotion, Belgium/Communications Consultants, South Africa

Circle 186 on Reader Service Card

CMX
ORROX



Lighting and power gear from Frezzolini.

compact Trim-Pak camera battery.

Christie joined the movement with its KS1 ac adapter, which weighs three lbs. and mounts horizontally or vertically. The company also introduced new super nicad batteries for cameras and VTRs and showed its established ReFlex-20 "burping" charger and battery system.

Frezzolini's "On-Board" ac adapter, Model RPS-1, was shown in a production model. The new MBC-5 multiple charger, for worldwide use, will simultaneously recharge eight BP-90 type battery packs overnight. The company also introduced the FBP-90 and FBP-90FC dc power systems, which double ENG/EFP camera run-time—up to four hours.

Perrott Engineering was the only company showing a new silver-zinc system. The company's MP 300 Micro Mini 12 V 8 Ah system includes the PE 300 minicharger, MP 300 Kwik-Klip camera battery, and PE 37 VTR battery. Also new was System 300, twin 12 V battery packs with twin chargers.

Cine 60 brought two new fast chargers, a universal model for any 6 V to 30 V nicad battery and a portable 12 V dc model for nicad packs and belts. A new high-performance nicad battery pack for the Ikegami HL-83 camera was introduced, as were new battery cables for the HL-83 and RCA's TK-86. Cine



Perrott's MP 300 battery system.

60's other new item was a line of lightweight lithium backup and "expedition" batteries.

PEP Inc. had a new VTR battery, the V90, for the Sony BVU-50, BVU-110, and BVH-500. Chargers, batteries, and belts from Pag Power were on view at the Comprehensive Video supply booth.

John Chiles Inc., a newcomer to NAB but not to the broadcasting industry, displayed its full range of batteries, power packs, and chargers for video cameras. A line of sealed lead-acid battery packs and belts for video and film camera applications was shown by Portable Energy Products Inc.

For more information: Anton/Bauer LPS-3, PS-1, 687; Anton/Bauer Life Saver fast charger, Wide Range Micro Charger, 688; Anton/Bauer Trim-Pak battery, 689; Christie KS1, 690; Christie ReFlex-20 batteries, 691; Frezzolini Model RPS-1, 692; Frezzolini MBC-5, 693; Frezzolini FBP-90, FBP-90FC, 694; Perrott Engineering MP 300, 695; Perrott Engineering System 300, 696; Cine 60 universal charger, 697; Cine 60 portable charger, 698; Cine 60 camera battery, 699; Cine 60 battery cables, 700; Cine 60 expedition batteries, 701; PEP Inc. V90, 702; John Chiles power supplies, 703; Portable Energy Products sealed lead-acid batteries, 704.

Camera support

Innovations were few in the camera support area, but several companies introduced new models to their lines. One of these was Sachtler Corp. of America, appearing for the first time at NAB as a separate company. It brought two new fluid heads, both first seen in Montreux last year. The Video 25, a medium-sized EFP head, offers four steps of pushbutton control for camera weight and compensation for center of gravity displacement. Video 20 is a lighter version for ENG applications. The company also showed a prototype of the Video 35 studio head.

Listec added two new items to its line of Vinten support equipment: the Teal pneumatic pedestal for cameras

With flexible, field-proven, electrically transparent Phillystran® high-performance tower guys . . .



the next time you re-guy will be the last time you re-guy!

Phillystran HPTG for

- new towers re-guying
- insulating sections

"The leading edge on cloud banks generated static discharge on the metallic guys of our AM/FM tower. This caused on-and-off cycling of our transmitter.

"Phillystran eliminated that cycling problem. It also changed our D-shaped pattern into a preferred omnidirectional by eliminating the directional aspects common to steel guys."

Don Russell, Chief Engineer
WDAN-AM & WDNL-FM
Danville, Illinois

Phillystran HPTG, made with DuPont's Kevlar® . . .

1. simplifies installation or re-guying of AM, FM, AM directional and TV towers. Lightweight, flexible, yet as strong as EHS galvanized steel. Negligible creep and elongation for tension-once and walk-away installations.
2. eliminates EMI and RFI associated with steel guys . . . improves FM signals, while also eliminating UV degradation, chipping, water-intrusion and the breaking problems associated with fiberglass insulating sections.
3. maintenance-free. Nonconducting, noncorroding, nonmetallic. No painting or greasing required. Eliminates problems caused by severe chemical/industrial pollution. No insulators required. No problems with fire or vandalism because each socketed assembly includes a steel lead line.

"With Phillystran insulating sections, we had a 25% gain in our FM signal. Electrically-transparent Phillystran was our best investment in 1980."

Manuel Sanguinetti, General Mgr.
FRECUENCIA MODULADA S.R.L.
Radio FM 99, Lima, Peru

PHILADELPHIA RESINS CORP.



20 Commerce Drive
Montgomeryville, PA 18936
(215) 855-8450

call/write for new literature and proven solutions to your tower-guy problems.

Circle 188 on Reader Service Card



Ultra-Boom at Comprehensive Video booth.

up to 140 lbs. and the Avocet head ("probably the smoothest head at the show," according to a company spokesperson), which offers 90 degrees of tilt for cameras up to 30 lbs. A new feature for the Dolphin crane arm, exhibited previously, is remote control of camera focus and zoom.

The show-stopper at Comprehensive Video was the new Ultra-Boom,

which varies camera height, pan, and tilt simultaneously and smoothly. The unit has complete internal wiring for remote zoom and focus servo controls. Seen in prototype at the show, it was expected to be deliverable in 45 to 60 days and costs \$7000.

The Tulip crane from Matthews Studio Equipment was shown this year with some new accessories,

including a basket for the counterbalancing weights and a monitor holder designed to increase operator control of the camera.

Brand-new at the O'Connor booth was a portable mechanical pedestal that works on an air column and supports cameras up to 120 pounds. The company was having a contest to name the new pedestal, which costs \$2500 and is available on 60-day delivery. Also new was a line of aluminum tripods, based on the same design as O'Connor's wooden models.

Bogen Photo Corp. had several items not seen at previous NABs, including the 3066 fluid head, 3063 mini fluid head, 3061 heavy-duty tripod, 3067 dolly, and 3056 auto dolly. This camera support line is a new venture for the company, which has previously concentrated on lighting gear.

Arriflex had a new camera support line, consisting of the FL7 and FL3 fluid heads and cast aluminum tripod legs. The head has an advanced-concept fluid drag system; its counterbalance is steplessly adjustable. The aluminum handles can be mounted for left- or right-handed use. The head will tilt a full 160 degrees without a wedge and the large claw ball will tilt an additional 30 degrees.

BARCO
CHROMA DECODERS
FEATURING A UNIQUE
COMPLEX COMB FILTER

- Normal Bandpass and Notch Filter
- Switchable: One Line Comb Filter Or Complex Comb Filter
- 2 Composite Inputs + RGB + Sync.
- Also PAL and SECAM.

Sole Distributor for BARCO VIDEO SYSTEMS
Rohde & Schwarz Sales Co. (U.S.A.) Inc.
 14 Gloria Lane, Fairfield, N.J. 07006
 (201) 575-0750

Circle 189 on Reader Service Card

Winsted MATCHMAKER SYSTEMS
 for the customized approach to videoproduction centers.

1" VTR CONSOLE

Winsted's new model 3101-T console is designed for space efficiency and operator convenience. VTR turntable rotates for complete machine servicing, viewing comfort. Monitor bridge adjusts in 1" increments. Several models available.

For full-line catalog of editing, production and dubbing consoles, tape and film trucks, film and videotape storage systems, call toll-free or write:

THE WINSTED CORP.
 9801 James Circle
 Minneapolis, MN 55431
 612/888-1957

MODEL 3101-T

Phone Toll-Free
1-800-328-2962

Winsted

Circle 190 on Reader Service Card

STUDIO OR STADIUM, FUJINON'S NEW BCTV LENSES PLAY ALL THE ANGLES.

From super-wide to ultra-tele, in the studio or the stadium, Fujinon BCTV lenses are the clear winners . . . from any angle.

NEW. Fujinon's P28x15 ESM — the super studio lens. It gives you a wall-to-wall 15mm wide angle and a maximum aperture of F/2.2 which is maintained out to ten times. Even at 420mm, the F/4.2 allows you to keep your lighting levels reasonable. And for the tightest shots, the built-in 1.7X extender takes you to 714mm. Naturally, it has a built-in diascope for near instant computer setup. But range and speed do not reveal the incredibly sharp, bright, high contrast image the new 28X delivers. Its superior resolution and color performance place it ahead of any lens in its class.

NEW. Fujinon's P17x16.5 ESM — the standard studio lens. With a zoom range from 16.5 to 280mm, an aperture which will remain flat at F/2.1 out to 217mm and built-in 1.5X and 2X extenders, here's the lens destined to be the industry workhorse for years to come. Simply put, it offers virtually every performance and operating feature — including built-in diascope — you're likely to need.

Not new. Fujinon's P30x20 ESM — the super field lens. Whether picking up the clearest shot of the space shuttle lifting off or a concert stage from the back of the top balcony, it goes out farther and flatter to deliver outstanding images . . . especially under lighting conditions that leave other lenses in the dark. Total zoom range, with the built-in 2X extender

is an incredible 20 to 1240mm. The F/2.2 aperture remains flat from 20 to 418mm — and at 620mm is giving you F/3.2. No wonder the 30X lens is acknowledged by the industry as the finest field zoom available.

For more information on the newest

and finest BCTV lenses, and why they are the best performance investment for your new or existing cameras, contact Fujinon. Large format zoom lenses are another reason why the world sees itself more clearly through the eyes of Fujinon.

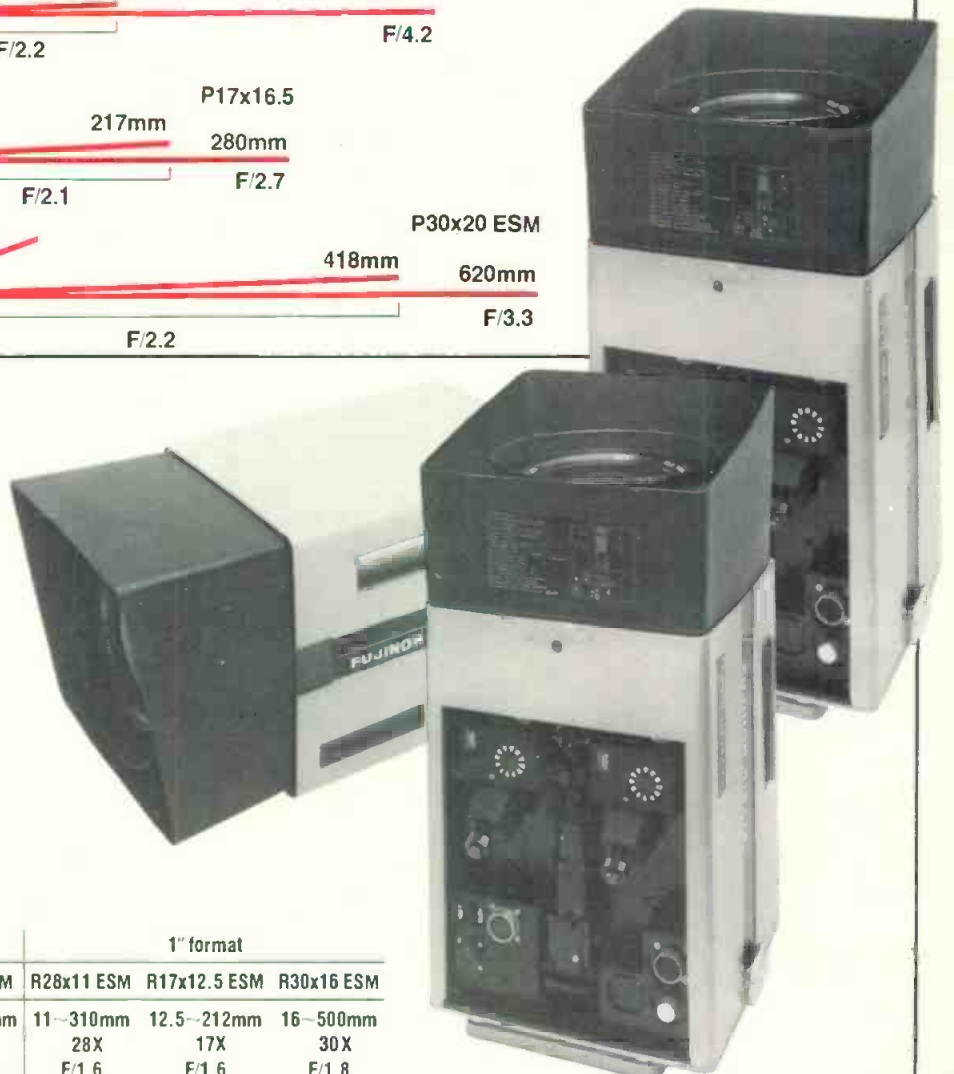
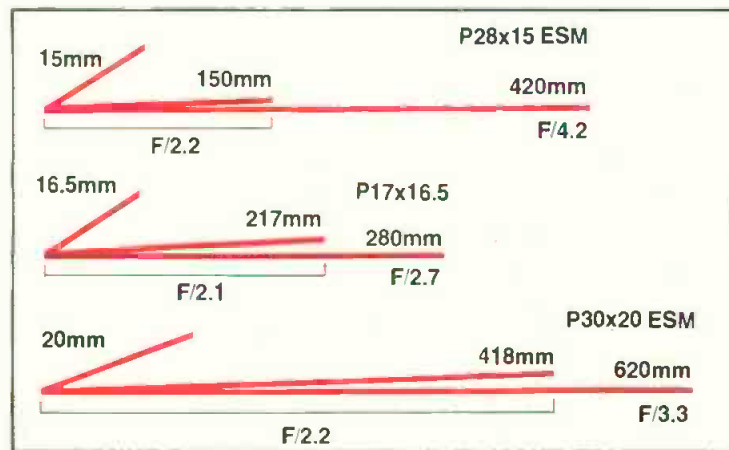

Specifications:	1 1/4" format			1" format		
	P28x15 ESM	17x16.5 ESM	30x20 ESM	R28x11 ESM	R17x12.5 ESM	R30x16 ESM
Focal Length	15-420mm	16.5-280mm	20-620mm	11-310mm	12.5-212mm	16-500mm
Zoom Ratio	28X	17X	30X	28X	17X	30X
Max. Aperture	F/2.2	F/2.1	F/2.2	F/1.6	F/1.6	F/1.8
M.O.D.	.95m	.75m	2.5m	.95m	.75m	2.5m
Range Extender	1.7X	1.5X, 2X	2X	1.7X	1.5X, 2X	2X



FUJINON INC. 672 White Plains Road, Scarsdale, New York 10583
(914) 472-9800 Telex: 131642

118 Savarona Way, Carson, California 90746
(213) 532-2861 Telex: 194978

Circle 191 on Reader Service Card

www.americanradiohistory.com



One of Sachtler's new fluid heads.

The Cinema Products booth once again featured **Steadicam**, the camera stabilizing system that has become a production mainstay for both video and film users.

Innovative Television Equipment added two new fluid heads to its line, the **H16** for ENG cameras and the **H9A**, a smaller version of the H9. The company also has a new tripod with ball leveling, Model **T8**.

Karl Heitz Inc. showed the **Gitzo** line of heads, tripods, dollies, monopods, and accessories. **Quick-Set** featured its **System 2000** modular tripod system, built around a multipurpose mounting plate and extendable crutch legs.

A newcomer to NAB, **Bush and Millimaki Services** brought the line of Universal fluid heads from Australia, including two new models, the **12BVSL** and **12BV**. The company, which also showed a line of wooden tripods, is just now making a play for the broadcast market.

A useful item from **Film/Video**



Listec showed Vinten's Teal pedestal.

Equipment Service Corp. was the **Kangaroo** video pack, a waterproof fabric VCR carrier with room for tapes, batteries, cables, and mics.

Q-TV Telesync and **Telescript** both brought their teleprompting systems, familiar to attendees of previous shows.

For more information: Sachtler Corp. Video 25, Video 20, 705; Listec Teal pedestal, 706; Listec Avocet head, 707; Comprehensive Video Ultra-Boom, 708; Matthews Tullip crane, 709; O'Connor pedestal, 710; Bogen Photo Corp. 3066, 3063, 3061, 3067, 3056, 711; Arriflex FL7, FL3, 712; Innovative Television Equipment H16, H9A, T8, 713; Bush and Millimaki 12BVSL, 12BV, 714; Film Video Equipment Service Corp. Kangaroo pack, 715.

Racks, cases, furniture

There was a good amount of activity in the cabinet field, with several companies showing new items. **Winsted** introduced the **System/85** line of modular video consoles, designed to hold Sony 800 Series and Type 5 U-Matic VCRs. The 19-inch units come in a variety of configurations and offer a full line of accessories.

Emcor, returning to the NAB after a four-year hiatus, brought its **10 Series**, a new line of cabinets for any kind of broadcast equipment. The cabinets have 19- or 24-inch openings for equipment mounting and accessories.

Amco introduced a new commercial EMI cabinet, the **CRFFX**, which meets the new FCC specification for interference protection and comes in a variety of dimensions. The company also showed a variety of equipment consoles and modular cabinets.

Storeel Corp. returned to NAB with its well-established line of storage systems for video and audio tape.

Cases, too, showed some activity, with three firms making their maiden NAB appearances and several established companies showing new items. Industry veteran **Anvil** brought a new line of shock-mount rack cases, with double plywood walls separated by a two-inch layer of high-density foam. The company also showed new monitor cases, and described its full line of standard and custom-built shipping cases, including A.T.A. cases for air travel.

Fiberbilt introduced its polyethylene **Supercase**, available in standard or custom sizes for cameras, recorders, and other broadcast equipment. The company calls it its strongest, lightest case yet.

New from **Excalibur** was a **VTR case** that allows in-case operation. With a special interlock feature (available for any of Excalibur's cases), two



Winsted's System/85 VCR console.

smaller cases can be locked together for shipping.

One of the newcomers was the **Calzone Case Co.**, which has mainly concentrated on the music business in the past. Calzone's wheeled amp racks, custom cases, A.T.A. cases, and tool cases are constructed of plywood with formica lamination and custom padding.

Hardigg Industries, another NAB novice, showed a line of molded polyethylene cases for any kind of electronic equipment. The company also featured a line of polyethylene cushions that allow delicate equipment to be shipped by commercial carriers.

William Bal Corp. has been selling to the broadcast industry for 10 years, but didn't make it to NAB until this time. Bal's video shipping cases are molded of Aero-Lan high-impact, water-resistant material; foam interiors can be cut to order. The company also has plywood cases.

Parsons Manufacturing, at its second NAB show, displayed a wheeled case with retractable wheels and handles, especially suited for air travel.

Thermodyne International came back with its **Shok-Stop** cases, first seen at last year's show. The company also featured its **Rack-Pack**, for rack-mounted equipment.

Environmental Container Systems had its established line of watertight fiberglass cases in custom and standard sizes.

For more information: Winsted System/85, 716; Emcors 10 Series, 717; Amco CRFFX, 718; Storeel storage units, 719; Anvil rack cases, 720; Anvil monitor cases, 721; Fiberbilt Supercase, 722; Excalibur VTR case, 723; Calzone cases, 724; Hardigg Industries cases, 725; William Bal video shipping cases, 726; Parsons Mfg. cases, 727; Thermodyne Intl. Rack-Pack, 728; Environmental Container cases, 729.

TV test equipment from the inventors of the Plumbicon® tube.

At long last a new, reliable source of TV test equipment. One that offers fast, predictable delivery. One with a name all the world trusts—Philips. Four quick examples:

PM5565 Waveform Monitor

Enjoy the luxury of examining one line and one field at a time. On top of this, there's a convenient front probe input so you can use the monitor as a troubleshooting oscilloscope.

PM5567 Vectorscope

If you want more accurate decoding and the ability to have an external reference from composite video signals, choose our vectorscope.

Both waveform monitor and vectorscope mount side by side, fit all existing hardware and use less power than the competition.

PM5539 Color Analyzer

Take it on a quick trip through your studio or control room and adjust all monitors to the same color temperature in a matter of minutes.

With four different memories, there's no problem in quickly calibrating four different phosphors.

Variable full-scale, from less than set up to more than reference white, allows measurement of color tracking as a function of APL.

PM5534 Color Pattern Generator

Our universal pattern contains all the signals needed to verify overall system operation—directly from the picture. No wonder virtually every set manufacturer uses our pattern for their TV set alignment.

Of course our TV test equipment line doesn't end here. Today Philips offers a wide range of equipment including sync and pattern generators, VITS generators and analyzers, and TV modulators and demodulators.

For nationwide sales and service information call 800-631-7172, except in Hawaii, Alaska and New Jersey. In New Jersey call collect (201) 529-3800, or contact Philips Test and Measuring Instruments, Inc., 85 McKee Drive, Mahwah, New Jersey 07430.

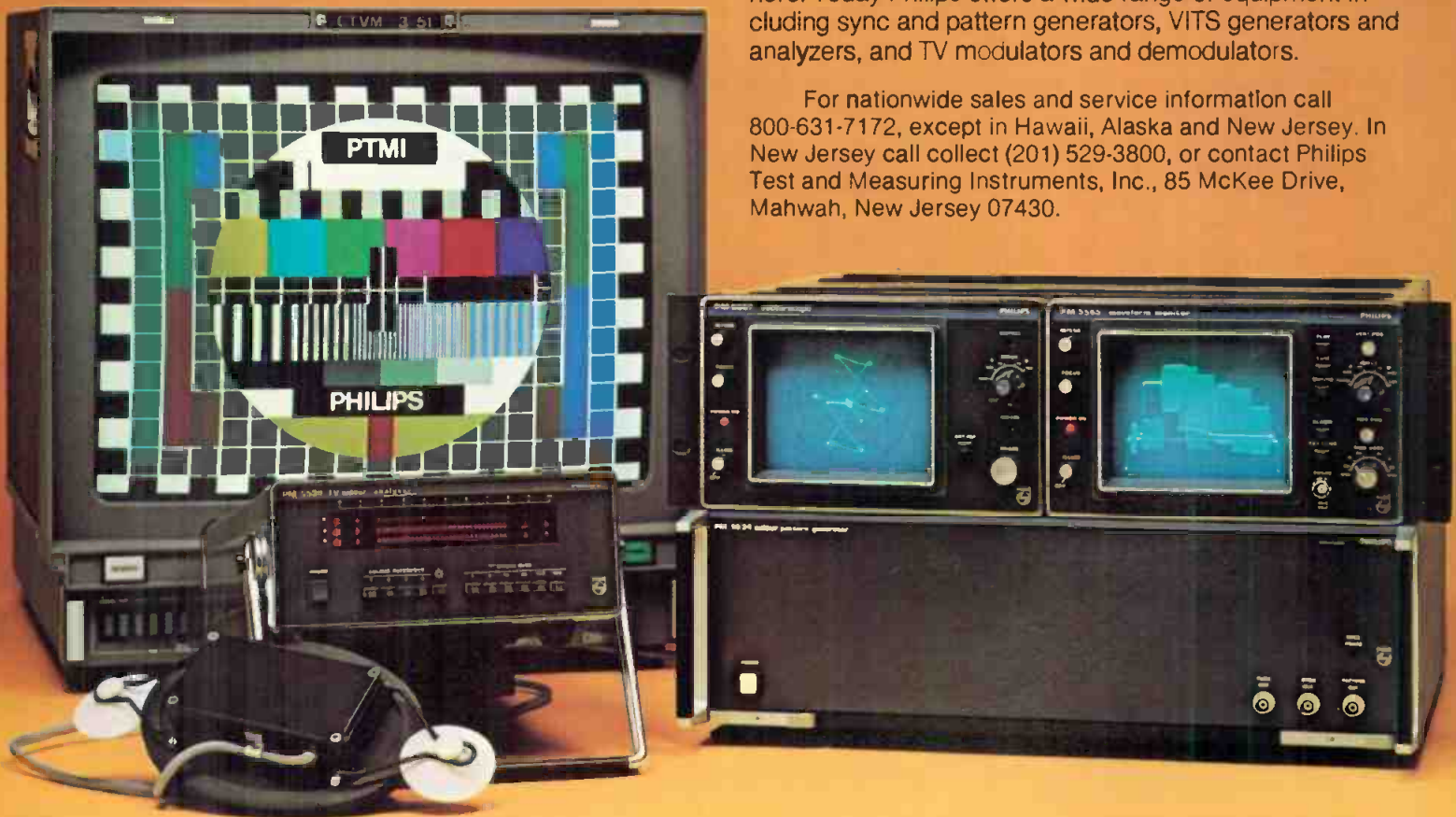

Philips, of course.



Test & Measuring
Instruments

PHILIPS

Circle 192 on Reader Service Card

www.americanradiohistory.com

DATAMETRICS TOOK THE TIME TO LISTEN TO YOUR TIME CODE NEEDS



Nobody knows better than production engineers how important equipment flexibility is in the efficient use of SMPTE Time Code. So Datametrics listened to engineers, and designed a comprehensive line of time code equipment to meet every need.

Rugged portable code readers. Highly legible displays. Low-profile readers and generators. Even comprehensive systems that incorporate complete generate, read and video display capabilities in one compact case. Datametrics has the package you need, but that's only the beginning.

Even our most cost-effective units incorporate features you'd expect to find on higher priced models.

For example, Datametrics' lowest cost studio code reader offers video insertion capabilities for monitor viewing and code burn-in to work prints. And we added options that offer even greater flexibility ... at lower cost.

But we didn't stop there. Datametrics leads the industry in innovative features that greatly extend the potential of time code. Our newest code reader offers automatic segment duration calculation. Video titling capabilities. And it decodes and displays Time and User data ... simultaneously.

Contact Datametrics. From basic time code management to the most technically advanced

computer-compatible systems, we make time code work to your advantage. Time after time after time.

Ask for a free copy of the new SMPTE Time Code Handbook, and learn how to make more effective use of time code in your facility.



datametrics

Datametrics Inc.
340 Fordham Road, Wilmington, MA 01887
Tel (617) 658-5410/TWX: 710-347-7672

NEWS FEATURE

AM Stereo: can broadcasters influence the outcome?

THERE ARE BIG STAKES riding on which AM stereo system will win the free marketplace race touched off by the FCC's reluctance to crown a winner on its own (*BM/E*, May 1982, p. 8). The proponents of four systems—Harris, Kahn/Hazeltine, Magnavox and Motorola—have left the gate and are galloping furiously for the big pot—put at \$20 million for exciter-transmitter manufacturers alone, according to Harris Corporation. But there are two other purses to be divided, both bigger: one going to receiver manufacturers if they pick a winner and another to broadcasters.

Harris's estimate of the \$20 million that will be spent on transmission equipment assumes half will come from the U.S. and half from international markets. AM stereo receiver manufacturers might tend to profit by \$12-15 million annually assuming a normal markup on stereo receivers, which will sell for about 10 percent more than the average standard set. On the other hand, a receiver manufacturer could quickly lose \$100 million just by entering the race if it chose to produce a decoder for a system that broadcasters and consumers shunned.

It's hard to put a dollar value on what AM broadcasters have riding. Some think it's a matter of life and death. AM listeners are steadily gravitating to FM, and AM station resale prices have peaked. Although many have already invested in a stereo studio in anticipation of a new standard, others, such as Gary Stevens at Doubleday Broadcasting, have said AM stereo offers too little too late (*BM/E*, February 1982, p. 89).

But judging from the strong feelings of broadcasters who were able to get to a floor microphone at the AM Stereo panel session during the 1982 NAB Convention, there is more than profit or loss at stake. There is pride. AM stereo represents a chance not simply to go two channels but to rid the industry of the curse of limited bandwidth radio. Indeed, Bart Locathi of Pioneer and Dan Schockley of National Semiconductors, who both proposed quick adoption of the Magnavox system at the NAB panel, were taken aback by the hostility directed toward them for ostensibly basing a recommendation on

lowest receiver manufacturing cost. By the same token, Bob Dietz, chief engineer at WABC Radio, drew applause when he pleaded with all concerned not to take the expedient route. He argued, rather, for the industry to take all the time necessary to pick the one system that will truly serve broadcasters. "Now is our chance," he said. Such a system will not be the one that offers a quick fix to AM broadcasters' prob-

lems by offering a new hype (stereo) but will be, instead, one that goes back to basics and broadens bandwidth—assuming one can have both selectivity and bandwidth.

Delco better bet than broadcasters?

Is there a role for broadcasters? Will Delco provide the answers? Can broadcasters influence the outcome or will receiver manufacturers make the final

FCC's Final AM Stereo Evaluation 3/18/82

EVALUATION CATEGORY

Numbers in parentheses () indicate the maximum possible scores.

MONOPHONIC COMPATIBILITY

	MAGNAVOX	HARRIS	MOTOROLA	KAHN	BELAR
Average Harmonic Distortion (15)	15	6	9	12	9
Mistuning Effects (5)	5	5	5	5	5

INTERFERENCE CHARACTERISTICS

	MAGNAVOX	HARRIS	MOTOROLA	KAHN	BELAR
Occupied bandwidth (10)	3	10	4	6	5
Protection ratios (10)	7	8	7	9	1

COVERAGE (Relative to Mono)

	MAGNAVOX	HARRIS	MOTOROLA	KAHN	BELAR
Stereo to mono receiver (5)	5	5	5	5	5
Stereo to stereo receiver (5)	-	-	-	-	-

TRANSMITTER STEREO PERFORMANCE

	MAGNAVOX	HARRIS	MOTOROLA	KAHN	BELAR
Distortion (10)	8	6	8	4	.8
Frequency response (10)	8	5	5	8	6
Separation (10)	10	10	10	3	8
Noise (10)	6	8	10	8	6

RECEIVER STEREO PERFORMANCE

	MAGNAVOX	HARRIS	MOTOROLA	KAHN	BELAR
Degradation in stereo performance over that measured at the transmitter, including consideration of directional antenna and propagation degradation (10)	9	9	8	5	5

TOTAL SCORES	MAGNAVOX	HARRIS	MOTOROLA	KAHN	BELAR
	76	72	71	65	58

NEWS FEATURE



Receiver industry spokesmen at NAB panel on AM stereo included, left to right, Jon Strom, Sony; Bart Locathi, Pioneer; Amond Clegg, Matsushita; Dan Shockey, National Semiconductor; and R.J. McMillin, Delco. Not shown were Robert McCarthy, Magnavox and Frank Hilbert, Motorola.

decision? If it is the latter, will they consider the broadcaster's view? Does the opinion of informed broadcasters who have truly examined the competing systems count? Will the aggressiveness of Harris, which has done an impressive job by lining up over 100 broadcasters favoring its linear system, have an impact? Or will receiver manufacturers decide solely on the basis of their own analysis of price performance—what they think consumers will buy?

There is no clear-cut answer. If it turns out to be Harris or Kahn, then certainly the voice of broadcasters will have been heard. If Magnavox wins, it could be considered a receiver manu-

facturer decision, though there certainly are some broadcasters supporting this system. Should Motorola emerge as the dark horse winner, it will be by sheer force of compelling cost-performance arguments that receiver manufacturers are likely to make. And set makers have not ruled out the Belar system even though it is not being aggressively promoted by anyone. If a non-synchronous detector seems preferable, it's a small step from Magnavox's phase modulation approach, which requires synchronous detectors, to Belar's FM modulation system, which does not.

Japan alone may not make the decision, despite the fact that seven of the

top 10 receiver manufacturers are headquartered there.

Indeed, for those making bets today, the odds favor not Japan, but Kokomo, IN, the home of Delco Division of General Motors. As the world's number one automobile receiver manufacturer and fourth among the radio industry giants overall, Delco has clout. Unable to make up its mind on the basis of what it has seen or read so far, Delco has decided it must run more tests. Uppermost is which of the competing systems will work best in the harsh automobile environment.

Most AM broadcasters would agree, AM stereo performance in a car is the crucial test. But mobile tests were al-

Telemetry Problems?

Many subcarrier and telco telemetry circuits are shakey, making telemetry return the weakest link in broadcasting. The Marti TSL-15 is solving these problems.



TSL-15

This link consists of a 15 watt type accepted transmitter, a narrow band receiver and Yagi Antennas designed for 450-456 MHz. group P channels. This system will provide continuous-duty operation, and can handle data and voice in a 20Hz.-3000Hz. band. Test meters are provided on both transmitter and receiver. Automatic station identification is available and external DC operation is provided for.

MARTI MARTI Electronics, Inc.
1501 N. Main • P.O. Box 661
Cleburne, Texas 76031
(817) 645-9163 • Telex 794 835

Circle 194 on Reader Service Card

SMPTE EDIT-CODE READER AND CHARACTER-GENERATOR

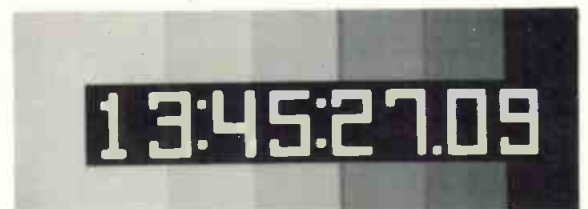

THE STANDARD OF THE INDUSTRY

FEATURES: The McFadin Window™ wide range digital decoder, highly legible and unique FONT, 1-3/4" rack mounting, vertical interval display, all front panel controls, drop frame indicator, choice of Time-Code or User-Bits, regenerated Time-Code output (DUB). MODEL DR-107A

GRAY ENGINEERING LABORATORIES

504 W. Chapman Ave.
Orange, Ca. 92663 714-997-4151

Circle 195 on Reader Service Card



INNER VIEW 2: A closer look at Conrac Monitors

Matched Phosphors: Different screens, same shade.

There's nothing magical about how we achieve the same picture on several Conrac monitors. Hue for hue, shade for shade, the colors are an exact match.

Conrac achieves this color reproducibility with its Colormatch™ picture tube. A precision-made CRT whose screen phosphors are closely controlled to fall within ± 0.005 tolerance of specific chromaticity coordinates (as measured on the CIE colorimetry chart).

And, since every Conrac Colormatch™ phosphor CRT adheres to this CIE standard, the subtle color tones you get on one monitor will be precisely duplicated on every Conrac monitor with a Colormatch™ phosphor CRT.

Correct color reproduction: Conrac precision at work.

Conrac's precision decoder delivers an accuracy of 2%, as measured on NTSC color bar test signals. This assures you that the color signal in each Conrac monitor is being properly separated and controlled.

Conrac's picture quality comes from a number of engineering advances.

One of these is demodulator output filtering. Tunable filters allow precision alignment of the sharpness of the color demodulation signals. Result: crisp, clear color separation with no

ringing, preshoot or overshoot distortions. There's also Conrac's highly accurate decoder. If the decoder is inaccurate (illustration), the blue color bars will be unequal in amplitude and produce shade differences as seen on the color bar display. Conrac's decoder, on the other hand, is precisely aligned to produce color bars of equal amplitude and shading.

Conrac Technology: Over thirty years of leadership.

Conrac's track record of technical innovation stretches back more than three decades.

And what we've learned since then goes into every monitor we make today. That's important to you. Because the more technology we pack into each monitor, the more performance you'll receive from it.

Matched phosphors and color stability are just two ways Conrac technology can save you time and money.

For the complete inner view of Conrac technology, call or write us today: Conrac Division, Conrac Corporation, 600 North Rimsdale Ave., Covina, CA 91722, Telephone: (213) 966-3511, Telex: 67-0437.

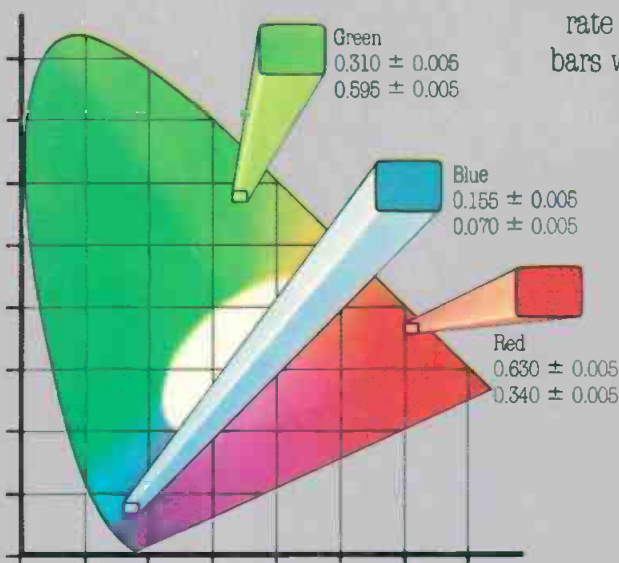

Conrac ensures a ± 0.005 tolerance for their CRT phosphors.

Oscilloscope waveforms show how Conrac achieves color quality by ensuring precise demodulator phase separation.

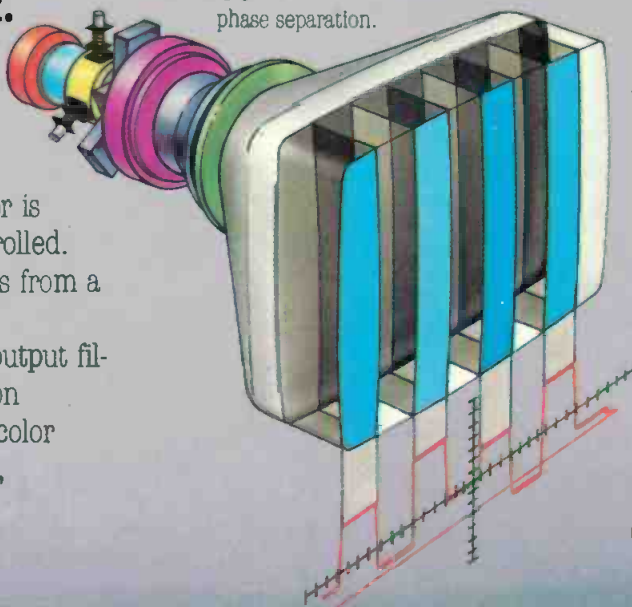

Quality you can take for granted.

NEWS FEATURE

most totally ignored by the NAMSRC tests of 1977—an “incredible” fact, laments Leonard Kahn, developer of one of the systems favored by broadcasters.

R.J. McMillin, director of engineering for Delco Electronics, outlined in mid-April the tests Delco will make on the four contending systems. These tests will involve not only bench evaluations but mobile field tests as well.

All factors concerning the receiver's cost and performance will be examined. Close scrutiny will be given to the

performance of the decoder and pilot detector used in the various systems. Such items as alignment necessary by the set manufacturer, varactor overload effects, oscillator noise, system phase noise, cross conversion effects at different times of the day, and the cost of adding pilot tone and extra output are targeted for study.

Performance of decoders will be evaluated in terms of distortion, separation, $S + N/N$, incidental phase modulation, full modulation effects, co-channel interference, and adjacent

channel interference. Pilot signal detector factors to be examined include acquisition time, false triggering susceptibility, co-channel triggering, pilot circuit complexity, and transition effects between stereo-to-mono and mono-to-stereo.

Presumably these tests will sort out some of the claims and counter-claims made by the various proponents of systems. And unlike the early NAMSRC tests, the Kahn system will be tested alongside the others.

McMillin reports that all system developers will be cooperating, as might be expected under the circumstances. Every system proponent has publicly said that they welcome the tests, and each is expected to supply several receivers.

Field tests at Delco, as distinct from bench tests, will use broadcast signals. Effect of a station's range and antenna patterns will be studied and particularly receiver performance at fringe areas and in strong signal areas. Occupied bandwidth, false stereo effects, and modulator processing effects will be observed as well as the effect of sideband asymmetry. Atmospheric effects will also be examined, including effects of skywaves and selected fading.

If none of the above tend to favor one system over another (previous analyses by other receiver manufacturers were undecisive in terms of performance), perhaps the “road tests” Delco plans will sort out winners and losers. Multipath, nulls, reradiation from power lines, impulse noise, switch pops, loss of signal on bridges, pilot tone signal acquisition time (and attendant transition effects), plus stereo image shift will be studied in a moving car. Receiver performance in the presence of strong, fringe, and varying signals will be closely observed.

These tests begin this month, and by early August Delco could decide which system it favors—in time to make some impact on the 1983 model year.

More tests desirable

While it is hard to believe that broadcasters alone could force a standard inasmuch as they seem divided themselves on what system they consider best, not to mention anti-trust implications which are real according to NAB, more practical evaluation by broadcasters could help clarify some of the issues. Those broadcasters who test more than one system are in the best position to choose and influence others.

There are differences in the various systems and none too many tests. A great many of the claims for one system and against another are based on paper analysis or mathematical deductions

PLAN TO BE AT

JAPAN

BROADCAST SHOW

JAPAN WELCOMES U.S.

- EXHIBIT AT Inter BEE
- ATTEND TECHNICAL STUDY TOUR
- JOIN U.S. DELEGATES TOUR

TOKYO — NOV 7-14, 1982



Inter BEE

FOR FURTHER INFORMATION RETURN COUPON TO

C.T.I., INC.

870 MARKET ST SUITE 740
SAN FRANCISCO CA 94102
TEL (415) 433 3072

Inter BEE/U.S. REPRESENTATIVE

NAME _____

EXHIBITION SPACE

COMPANY _____

TECHNICAL SYMPOSIUM

ADDRESS _____

U.S. DELEGATES
TOUR PACKAGE

CITY _____ STATE _____ ZIP _____

Routing
Switching
Equipment

3M

PROFESSIONAL VIDEO EQUIPMENT
Magnum Audio Video
Products Division 3M
3M Center, St. Paul, MN 55133

3M

Taft Broadcasting Company
1718 Young Street
Cincinnati, Ohio 45210

Taft Broadcasting is an immensely successful communication company with TV stations in seven major markets. Their quality standards are tough. Their business standards are demanding. And that's why, for the past three years, Taft has been sold on 3M Routing Switchers.

We lived up to their standards by saving them time and money. We saved them installation costs by setting up quickly and easily. We saved them equipment costs by doing more with less. And we saved them manpower and modification costs by expanding the system as their needs expanded. With 3M Routing Switchers, Taft was faced with add-ons, but never with obsolescence. They know our system will be as state-of-the-art tomorrow as it is today.

Our system can be as simple as a 10x1 or as sophisticated as a computer interfaced system controlling tape and film machines, printing logs, or connecting any combination of inputs to any combination of outputs. All at the touch of a button or the pulse of a computer command.

Virtually all 3M switching equipment is

microprocessor-based, so you can delegate control to individual stations, yet lock out other stations to prevent operational interference. You can route audio and video separately. And all controls are connected by one coaxial cable.

We offer five series of switchers, with your choice of control panels. And each one is designed to stay on the job for years.

For a firsthand impression of 3M Routing Switchers, check with John Owen, V.P. Television Engi-

neering at Taft Broadcasting. So far, he's only had one complaint: "I wish we would have had them in '76, '77 and '78".

If you'd like more information about 3M Routing Switchers, call us collect at 1-612-733-8132. Or write us on your letterhead at 3M Professional Audio/Video Equipment, Bldg. 223-5E, 3M Center, St. Paul, MN 55144. For inquiries from outside the continental U.S., call or write, International Operations, 3M, Bldg. 220-5E, 3M Center, St. Paul, MN 55133. 1-612-736-2549.

When you're
Taft Broadcasting,
you can't afford
second best.

3M hears you...

3M

THE MOST ADVANCED CHARACTER GENERATOR ISN'T JUST A CHARACTER GENERATOR!

The Dubner CBG is a full-functioned character generator with features you won't find anywhere else — like diagonal typing, colored edges and 3-D, two-color drop shadows.

But it's also a background generator! Its background capability allows complete control of every dot in every line.



Animated logo: Beginning with a single image, a complete, multi-colored logo design unfolds on the screen.

You can choose from over 500 colors to create pictures of startling complexity and beauty — and recall them in a fraction of a second!

You can play back a sequence of pictures at up to 30 frames-per-second and — without leaving your studio — produce animations that rival the most expensive post-production results.

The CBG has proven its superior performance on many of the ABC-TV Network's productions, including *Wide World of Sports* and *20/20*. You've seen the CBG's maps and vote boards on ABC's coverage of the most recent national elections, and the colorful flag displays the CBG created for the Winter Olympics in Lake Placid.

But that's not the end of the CBG's possibilities. It was designed to be expandable without hardware modifications. New effects and enhancements are constantly being developed which can be incorporated into your CBG by simply changing its program disk.



Growing Images: On a static background, a new image grows and zooms forward, overlaying the original image.

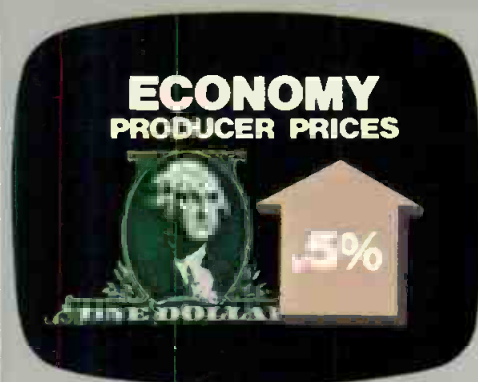

"Cut and Paste": Various images can be enlarged, reduced, repositioned, overlaid and recolored to produce complex graphics.

So, if you're in the market for an advanced character generator, why not get one that's a background generator as well, for about the same price! Check out the Dubner Character/Background Generator, today!

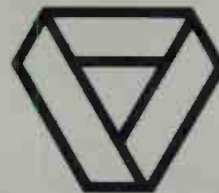

**Dubner Computer
Systems, Inc.**

**Our machines are getting
smarter all the time!**

158 Linwood Plaza
Fort Lee, N.J. 07024
(201) 592-6500

NEWS FEATURE

and not on hard empirical data. The Magnavox system, which was the FCC's choice as a single standard in 1980, might not be the best bet by broadcaster-set criteria. Those who question it most are concerned that there may be a loss in monophonic loudness when transmitting in stereo and that there may be popping sounds produced in a stereo receiver during high negative peak modulation conditions. Another concern that reached the FCC was that high frequency response might have to be restricted to receive a program both monophonically and stereophonically, (paragraph 14, Report and Order Document 21313).

Although the Magnavox system still comes out with the best overall score in the 1982 FCC evaluation (see chart), the Commission admits that some criteria could not be adequately quantified to be considered and that in other categories insufficient data were available—such as coverage related to stereo. Even when scores are given, the qualifications must be remembered. For example, Magnavox, Motorola, and Harris all got top marks in separation. This is because the frequency range for the scoring was limited from 200 to 5000 MHz. At a higher limit of 7500 MHz, Magnavox would have suffered, and at 15,000 MHz, Harris would win. The validity of the chart is further questioned by those who point out that a small shift in a corner frequency of the Belar system would make it equal to the Magnavox.

The FCC admits that some important factors may not even be on the chart and gives a nod to Harris by indicating, in Appendix E of the Report and Order, Harris's mathematical analysis showing the virtues of its linear system.

In short, additional field tests of all systems under comparable conditions might show up a new winner. This is what Leonard Kahn is banking on—tests in the real world and not in the laboratory. He is sure that some systems will fail because of phasing errors (which create undesirable sibilances) and others will flunk when adjacent channel interference is present (which causes sputtering). Motorola is convinced that more side-by-side tests will show up its compatible quadrature system to outperform others in terms of modulation induced noise and interference. Motorola says that it has valuable data that it submitted to the FCC but that went unreported because others did not have similar information.

Development of a universal decoder permitting several systems to operate is a very remote possibility for reasons of cost. Therefore, harder decisions have to be made.

BM/E

REVOLUTIONARY
NEW

ISOMAX™

MICROPHONE

IMPROVES:

- ↑ "on mike" sound
- ↑ available gain without feedback
- ↑ isolation for conferences & interviews
- ↑ matte black finish looks great on camera

REDUCES:

- ↓ room rumble & echo
- ↓ clothing noise
- ↓ camera noise
- ↓ paper shuffle noise

ISOMAX PRO
for balanced line battery
or phantom operation.

ISOMAX W
for use with all wireless
body pack transmitters.



COUNTRYMAN ASSOCIATES INC.
417 STANFORD AVE. - REDWOOD CITY, CA. 94063 - PHONE 415-364-9988

Circle 198 on Reader Service Card

Holding Things Together Since 1881

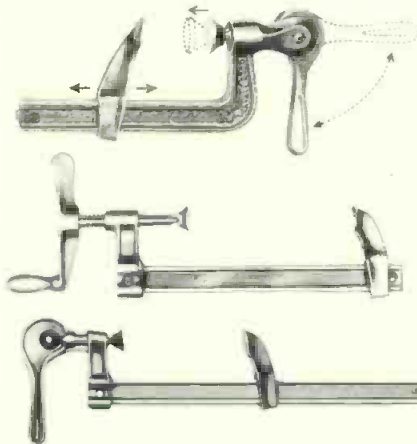

Write or call for a catalog and prices on our 8 eccentric and 12 screw types of time and labor saving clamps.

*Colt Clamps are an investment
—not an expense*

COLT CLAMP CO., INC.
33 Swan St. • Batavia, NY 14020
(716) 343-8622

Circle 199 on Reader Service Card

NEW! Book VIDEOTAPE EDITING

Videotape Editing-Communications With Pictures And Sound answers every videotape editing question:
When to edit? When to (and when not to) use a dissolve or wipe? How to cut? How to use complex sync role editing and audio sweetening? How to affect the mood and pace of a show? Why and how to perform computer editing without losing creative control? It even takes the mystery out of time code and user bits.

Beginning editors, experience pros, film editors, and media managers will all appreciate **Videotape Editing**. This new book is your guide through the world of computer assisted videotape editing.

Videotape Editing-Communications With Pictures And Sound By Michael D. Shteter
• 165 pp. • 144 illus. • 6"X9" • Hardbound
\$32.20 (\$34.00 in IL.)

Order Today!

Brochure Available

(312) 364-1900 Ext. 825

Major Credit Cards Accepted

SE Swiderski Electronics Inc.
Audio Video Engineers
1200 Greenleaf Ave. • Elk Grove Village, IL 60007

FCC RULES & REGULATIONS

the power output (1.5 W) and frequency tolerance (0.005 percent) of the pickup equipment.

- Also in the microwave portion of the spectrum, the Commission has indicated that it likes Marti Electronics' proposal to let radio and television licensees (but *not* CARS microwave systems) extend the range of their microwave studio-transmitter links and intercity relay stations with on-channel boosters. Generally, licensees now needing to extend these types of signals—whether to cover a long distance or to get around some obstacle blocking the signal—would simply use a repeater on a different frequency. Unfortunately, this approach is no longer available in many areas as a result of frequency congestion. In addition, a system that will deliver a signal from Point A to Point B on a single frequency utilizes spectrum more efficiently than a system that ties up two frequencies to do the same job. Thus, when Marti indicated the availability of technology permitting on-channel boosters, and sought rule changes to permit their use, the Commission thought it might just be a good idea, notwithstanding the possibility of interference to other users. As of this writing, the Commission is mulling over the comments submitted in response to its notice of proposed rulemaking.

- On the FM side, the FCC has finally decided it ought to define FM licensees' responsibilities for resolving blanketing interference caused to other stations. "Blanketing" occurs when a station's signal partly or completely blocks the reception of other stations; it is most likely to happen in the immediate vicinity of a station's antenna.

Beyond this fairly general definition, however, the FCC has yet to provide any detailed criteria as to when, precisely, FM blanketing can be said to occur. Perhaps more importantly, the Commission has yet to provide any guidance as to when a station must bear the financial burden of correcting blanketing when it does happen. The Commission is now considering precisely those questions, and other related ones, in a rulemaking proceeding aimed at offering FM licensees the same type of standards already available to AM licensees. At the suggestion of an organization of consulting engineers, the FCC has proposed to define blanketing as arising when an FM station's signal hits 115 dBu or greater. It's not just that simple, however. For example, if a blanketing situation is created by two or more colocated stations, should the 115 dBu per station level be lowered? Should both stations be jointly responsible for resolving interference complaints in the blanketed area? What happens when a station joins others at a particular site? Should the newcomer be responsible for all additional interference complaints? These questions are under consideration.

- To make life a little bit easier for would-be general radiotelephone operator licensees, the Commission has streamlined the testing process. Under the old system, you used to have to pass the first and most difficult section—the so-called "Element 3," involving technical, legal, and other matters—before moving on to the second ("Element 1") and third ("Element 2") sections, which were simpler. Since virtually everybody who passed the



ANOTHER
NEW
FACE

GRAHAM-PATTEN SYSTEMS

INTRODUCES
THE MODEL 9402
A Versatile New DA Featuring
Differential Input
Switchable Clamping
Optional Cable Equalization
(fixed or variable)

And, like our already popular 9401 video/pulse DA, it fits in any Grass Valley Group, inc. standard 900 tray.



GRAHAM-PATTEN SYSTEMS, INC.
P. O. BOX 1960, GRASS VALLEY, CA 95945
[916] 273-8412

Circle 201 on Reader Service Card

FREE

This and other New York City locations. Plus one-stop information, permits, and problem solving.

Nancy Littlefield, Director
**MAYOR'S OFFICE OF
FILM, THEATRE AND
BROADCASTING**
110 West 57th St.
New York, NY 10019
(212) 489-6710
A Division of the NYC
Office of Economic
Development

FREE **NEW YORK CITY PRODUCES** FREE

Circle 202 on Reader Service Card



**"Confidentially...
the top news is
at the bottom."**

Whilst dropping to the bottom line please take note of our expanding line of proven American made cameras.

Now available in more models... for more users... in more places than ever before.

- **CEI 310:** Still the most versatile production camera going... and going... and going.
- **Panacam Reflex:** The premier electronic cinematography camera. More than just a superb "video camera", it's available for rent worldwide. Yes—worldwide.

Foton I: The "smart" one-inch microprocessor studio camera for smart buyers.



**Foton I
Studio
Camera**

CEI...now a PANAVISION company

880 MAUDE AVENUE/MOUNTAIN VIEW, CA 94043-4089/(415) 969-1910/TELEX: 348-436

Circle 203 on Reader Service Card

www.americanradiohistory.com

FCC RULES & REGULATIONS

first test ended up passing all three, the Commission combined the three exams into one. To simplify things even more, the Commission decided to give credit for Element 1 and 2 exams to anyone holding any commercial radio-telephone operator license (except restricted radiotelephone operator permits). This will affect primarily marine radio operator permittees, who never used to get this kind of credit.

● And last, but by no means least, so far this year the Commission has had to focus on a variety of international matters directly affecting U.S. broadcasters. For instance, last year's Region 2 conference on AM broadcasting established general standards to be applied to U.S. stations vis-a-vis the stations of other countries. The Commission must now review its own rules, policies, and procedures with an eye toward bringing them into line with the international accords. That's not as simple as it may sound, since the Region 2 conference left a number of matters open for bilateral agreements. As a result, the Commission is or will be involved in further negotiations with Canada and Mexico relative to AM protection standards and the like. Since these negotiations could lead to the availability of spectrum space (e.g., on the Canadian clear channels) for some additional full-time U.S. stations, their importance cannot be understated. An additional, continuing problem is presented by Cuba, which is something of a wild card in the international scheme of things. Cuba withdrew from the Region 2 conference and the NARBA agreement, and has been

creating interference problems for a number of U.S. stations, which in turn have been pushing the Commission to give them some kind of assistance. And, as if all of this weren't enough, the Commission also has to worry about the International Telecommunications Union's Plenipotentiary Conference scheduled for September through November, 1982, in Nairobi, Kenya. The ITU oversees international use of radio spectrum for "the improvement and rational use of all forms of telecommunications." Plenipotentiary conferences are convened every five to 10 years to permit revision of the ITU's basic charter. The U.S. proposals for the conference thus relate more to parliamentary and procedural matters, such as creation of certain voting procedures, advisory committees, and the like. While this may seem somewhat far afield of day-to-day broadcast regulation, one should recall the words of Sir Henry Maine, who stated, "the substantive law is sequestered in the interstices of procedure."

In light of all these activities, it is clear that the Commission still has its hands full, regardless of deregulation. Indeed, as deregulation takes hold and frees up staff time, the Commission may be able to dedicate even more of its resources to technical details and technical innovations. The result is likely to be overall improvement in the nature and quality of services available. If you would like further information concerning the proceedings described in this article, or if you would like to submit comments to the Commission with respect to any of the proposals, consult your communications counsel. **BM/E**

LOWEST PER CARTRIDGE COST*

THE LATEST MICROPROCESSOR TECHNOLOGY

WHY WOULD YOU BUY ANYTHING BUT

IGM GO-CART

In 24, 42 or 78-cartridge* capacity

Use 2 or more Go-Carts for back to back play of all programming, including music

OR

Add one to your existing system to handle all the commercials, ID's, and public affairs, leaving the music on reels or disks. Easily interfaced to most automation systems, ours or "theirs".

FAST! Worst access time is 8 seconds.

HUMAN ENGINEERED. Whole unit swings open for maintenance, even while on air.

IGM COMMUNICATIONS

4041 HOME ROAD, BELLINGHAM, WA 98226 [206] 733-4567

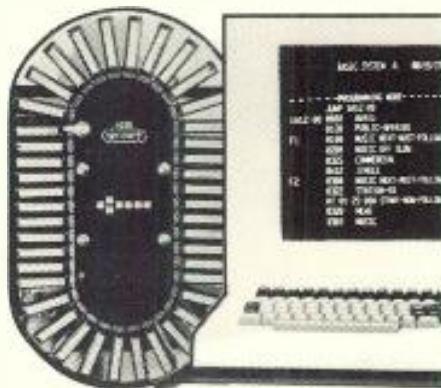

Circle 204 on Reader Service Card



DELAY LINES

Video•Pulse
Active•Passive•PC•DIP•
Boxed•Switchable•Variable
Rack mount cards.

LOW PASS FILTERS

Eliminate buzz caused by
spurious out-of-band spikes
from character generators.

NOISE MEASUREMENT FILTERS

An easy, economical method
of video noise measurement.

broadcast video systems Ltd.

1050 McNicoll Avenue
Agincourt, Ont. M1W 2L8
(416) 497-1020

Circle 205 on Reader Service Card



**ELECTRONIC INTERLOCK
MAGNETIC FILM
RECORDERS and REPRODUCERS**

**THE STANDARD OF HOLLYWOOD
AND THE WORLD**

FOR FILM AND TELEVISION RE-RECORDING
ELECTRONIC LOOPING
HIGH SPEED DUBBING
TELECINE MAGNETIC FOLLOWERS
HIGH SPEED PROJECTORS
VIDEO TAPE-FILM INTERLOCK SYSTEMS
TOTAL FACILITY ENGINEERING

Sydney
Magna-Techtronics (Aust.) Pty., Ltd.
P.O. Box 150
Crows Nest NSW 2064, Australia
Telex 24655

London
Branch & Appleby
42 High Street
Harrow-on-the-Hill
Middlesex HA1 3LL,
England

MAGNA-TECH ELECTRONIC CO., INC.

630 Ninth Avenue, New York, N. Y. 10036

Telephone (212) 586-7240

Telex 126191

Cables "Magtech"

Circle 206 on Reader Service Card

HITACHI

FP-22 Color Camera System

With Microprocessor for Automatic Set-Up



- 2-FP22-3 Tube Saticon cameras
- 2-A10 x 11 BRW 10-1 lens power zoom F1.6
- 2-Operation panels with 50' cables
- 2-5" and 2-1 1/2" View Finders
- 2-Lens drive kits
- 2-A.C. adaptors
- 1-PVM 8200 8" color monitor
- 1-WV 5203 triple 5" monochrome monitors
- 1-M67 audio mixer

- 1-6142 Crosspoint latch production switcher
- 1-6006 Sync generator
- 1-Service manual
- 1-528 Tektronic Waveform monitor
- 1-BPM-1 Burst Phase Meter
- 1-McMartin amplifier and speaker
- 2-sets batteries and charger
- 2-Sets wood tripods - O'Connor fluid heads - dollies with deluxe wheels

Modular three piece portable studio, packaged in protective cases with front and rear hard shell covers. Single cable interconnect between modules for quick and simple set-up.

\$45,600 Delivery and Warranties Included

Full line distributor
for all Hitachi
video products

LERRO
ELECTRICAL CORPORATION
COMMUNICATIONS SYSTEMS DIVISION
3125 North Broad Street, Philadelphia, PA 19132

For further details
215-223-8200
Ask for John Neri

GREAT IDEA CONTEST

Here's a chance to share your own personal solutions to some of broadcasting's most vexing engineering needs . . .

Each month, *BM/E* presents two engineering problems and invites you to submit solutions complete with diagrams. *BM/E's* editors will read the entries and select the best for publication—giving readers an opportunity to vote for the idea they consider best by using the ballot area on the Reader Service Card.

We will pay \$10 for each entry printed. In addition, the solution in each month's competition receiving the most votes on our Reader Service Card will win an engineering slide rule calculator. So put on your thinking cap and submit an answer to either of the problems outlined below . . . and be sure to watch this section for the solutions.

Problem 7: Intercom/IFB in the On-Air Console

Both radio and TV stations frequently need to communicate with on-air talent before or during transmission. Though separate intercom/IFB systems are available, do you have a plan for one which can be incorporated within an audio mixer so that program audio and communications can be simply integrated?

**Solutions to Problem 7
must be received by
June 15, 1982 and will be
printed in the August, 1982, issue.**

Problem 8: Call-In Indicator

For a call-in talk show, it is desirable to have a system that will put callers on hold until the call can be taken, and also indicate to the operator or host which call came in first. Devise a simple tally or indicator circuit for this purpose.

**Solutions to Problem 8
must be received by
July 15, 1982, and will be
printed in the September, 1982, issue.**

CONTEST RULES

- 1. How to Enter:** Submit your ideas on how to solve the problems, together with any schematic diagrams, photographs, or other supporting material. Entries should be roughly 500 words long. Mail the entries to *BM/E's* Great Ideas Contest, 295 Madison Avenue, New York, NY 10017. Use the official entry form or a separate piece of paper with your name, station or facility, address, and telephone number.
- 2. Voting and Prizes:** *BM/E's* editors will read all entries and select some for publication; the decision of the editors is final. Those selected for publication will receive a \$10 honorarium. Each month, readers will have an opportunity to vote for the solution they consider the best by using the Reader Service Card. *BM/E* will announce the solution receiving the most votes and will award the winner of each month's competition an engineering slide rule calculator.
- 3. Eligibility:** All station and production facility personnel are eligible to enter solutions based on equipment already built or on ideas of how the problem should be solved. Consultants are welcome to submit ideas if they indicate at which facility the idea is in use. Manufacturers of equipment are not eligible to enter. Those submitting solutions are urged to think through their ideas carefully to be certain ideas conform to FCC specs and are in line with manufacturers' warranty guidelines.

Mail Official Entry Form to:

BM/E's Great Ideas Contest
295 Madison Avenue, New York, NY 10017

Solution to Problem # _____

Your Name: _____

Title: _____

Station or Facility: _____

Address: _____

Telephone: (_____) _____

I assert that, to the best of my knowledge, the idea submitted is original with this station or facility, and I hereby give *BM/E* permission to publish the material.

Signed _____

Date _____

THE ULTIMATE SWITCH

isi 200 SERIES

POLYKEY[®] CONCEPT

DOWNSTREAM TRANSITION UNIT

AUTOMATED PRODUCTION EFFECTS (APE)

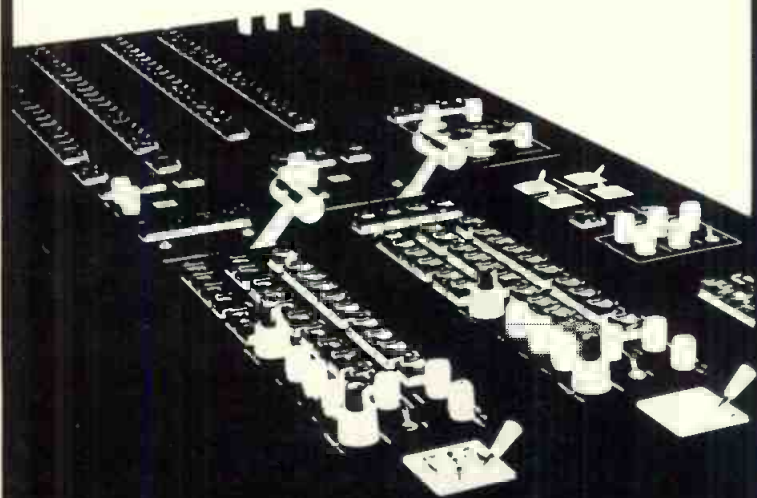

INDUSTRIAL SCIENCES, INC.

3521 S.W. 42nd Avenue
P.O. Box 1495
Gainesville, Florida 32602
U.S.A.

TELEPHONE

Outside U.S.A. 01 (904) 373-6782
In Florida (904) 373-6783
Sales (800) 874-7590
Service (800) 874-7874

CABLE

TWX 810-825-2307

Circle 208 on Reader Service Card

GREAT IDEAS

1981

contest winners

The votes have been totaled for the 1981 contest, and *BM/E* congratulates the following grand prize winners in the AM Radio, FM Radio, and TV categories. Each will receive a programmable electronic calculator:

AM RADIO

Marshall P. Brown, former Chief Engineer
KCEE-AM, Tucson, AZ
for "Editing Tape directly to Cart"
(November issue, #25)

FM RADIO

William Howe, Chief Engineer
WEIV-FM, Ithaca, NY
for "Tape Recorder Automation"
(December issue, #30)

TELEVISION

Jan R. Hall, former Director of Engineering
Hunter College, New York, NY
for "Video Test Pattern Generator"
(July issue, #16)

Our congratulations also to these runners-up who will each receive engineering slide rule calculators:

CATEGORY 1, AUDIO

Tom Rose, Engineering Manager
KQFM, Portland, OR
for "Stereo Line Amp"
(January issue, #3)

Craig S. Butler, former Chief Engineer
WVOJ Radio, Jacksonville, FL
for "Random Noise Generator"
(April issue, #14)

Donald R. Beckett, Engineer
KBYU-TV/FM, Provo, UT
for "Audio Signal Black Box"
(December issue, #28)

CATEGORY 2, RF

B.G. Parker, Transmitter Maintenance Supervisor
KCMO-TV, Kansas City, MO
for "Automatic Transmission Line Maintenance"
(May issue, #15)

CATEGORY 3, CONTROL

Jeffrey S. Close
Boulder, CO
for "Triac Turntable Starting System"
(March issue, #8)

Les Svoboda, Staff Engineer
KOLN-TV/KGIN-TV, Lincoln, NE
for "External Tally-Signal System"
(April issue, #13)

Bill Croghan, Chief Engineer
KCEY/KMIX-FM, Turlock, CA
for "Cart Auto Synchronizer"
(October issue, #22)

CATEGORY 4, VIDEO

John Hartwell, Engineer
KQED-TV, San Francisco, CA
for "Program Bus, Preset Bus Switching"
(May issue, #13)

Roger Culhane, Video Engineer
3M Corp., St. Paul, MN
for "TBC Modification for VTR"
(September issue, #21)

Our congratulations again to all the winners.

NEW Great Idea Contest Winner

Voting has been heavy in our new Great Ideas Contest which began in January. Our congratulations to W.O. Barker, chief engineer of WTLR-FM, State College, PA, for his winning Solution C to Problem 1: End-of-Tape Warning. (See pages 112 and 115 of the February, 1982, issue.) The solution has won Mr. Barker an engineering slide rule calculator.

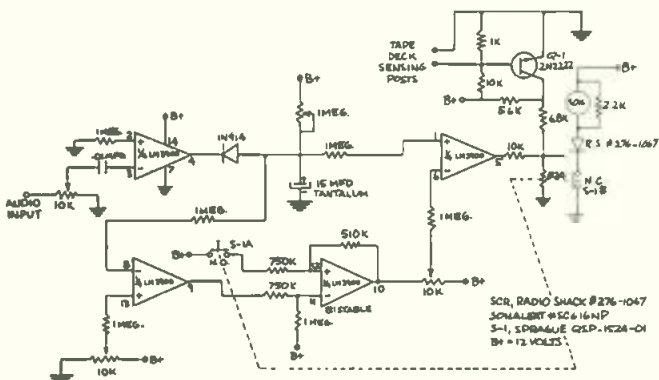

Perfect Timing

SMPTTE

TIME CODE READERS THAT YOU CAN AFFORD

ES251-Six digit SMPTE Time Code Reader displaying Hours, Minutes and Seconds. Reads at play back speed.

Momentary hold switch permits "freezing" of time displayed.

Releasing hold switch updates display to correct time.



\$295

ES252-Exactly like ES251, but displays Minutes, Seconds and Frames. \$300

ES253-Eight digit reader, displays Hours, Minutes, Seconds and Frames.



Reads at play back speed, has "freeze" control. \$454

ES254-BI-DIRECTIONAL, MULTI-SPEED (1/20 to 20 times), eight digit reader with "freeze" control. On loss of code, displays last valid code read. \$675

AND FOR OFF-LINE EDITING ES255 SMPTTE IN/VIDEO OUT

ES255 is an eight digit, multi-speed, bi-directional SMPTE reader which adds the SMPTE input to your video. You can now "burn" the time code into the video portion of your tape, or feed a monitor directly. \$995



Write, Wire or Call: (213) 322-2136
142 Sierra Street, El Segundo, CA 90245

Circle 209 on Reader Service Card

ADVERTISER'S INDEX

ADDA	3	EECO	115	Microtime	127
ADM Technology	15	Electro	100	Midwest Supply	19
Ampex Electronics	113	Electro-Voice	66	Motorola	39
Ampex-AVSD	11, 24-25, 117	ESE	153	NEC America	9
Ampex-MTD	73	Eventide Clockworks	84	N.Y. Mayor's Office, Productions	146
Anchor Systems	120	Fernseh	125	Orban Associates	46, 65
Asaca Corp of America	116	Fujinon Optical	133	Pacific Recorders & Engineering	36
Audiokinetics	22	Fuji Photo Film USA	123	Panasonic Matsushita	93
Audionics	48	Gotham Audio	108	Philadelphia Resins	131
Belar Electronics Lab.	154	Alan Gordon Enterprises	120	Phillips Test & Measuring Instruments	135
Beyer Dynamics	81	Graham Patten Systems	146	Potomac Instruments	54
Broadcast Audio	63	Grass Valley Group	7	QSI Systems	94, 108
Broadcast Electronics	18	Gray Engineering Labs	138	Ramko Research	42-43
Broadcast Microwave	83	Harris Corp	45, 67	RCA Broadcast	68-69
Broadcast Technology	64	Harrison	C-2	Recortec	90
Broadcast Video Systems	148	Hitachi	23	RF Technology	106-107
Canon USA	87	IGM	148	Rockwell Intl	56
CEI	147	Ikegami	99	Rohde & Schwarz	111, 132
Central Dynamics	27-34	Industrial Sciences	152	Sachtler	92
Cetec Broadcast	85	Interbee	140	Satellite Broadcast Network	102
Cetec Vega	16	International Tapetronics	55	Schneider TV Lenses	10
Chyron	70	Japan Electronics Show	124	Sharp Electronics	12-13
Cine 60	144	US JVC	118	Sony Broadcast	4-5, 88-89
Cinema Products	104	Lake Systems	112	Soper Broadcast	154
CMX/Orox	130	Lenco	105	Spectrasonics	78
Comex	47	Lerro	150	Storeel Corp	51
Comrex	53	Lexicon	62	Swiderski Electronics	143
Colt Clamps	143	3M/Magnetic Tape Div	76-77, 141	Telex Communications	97
Conrac	139	3M/Pro A/V	17	Thermodyne	121
Continental Electronics Mfg	62	Magna-Tech Electronic	149	Thomson-CSF Broadcast	75
Convergence	107	Marconi Electronics	101	Varian, Eimac Div	41
Countryman	143	Marti	138	Videotek	21
Crosspoint Latch	119	Maxell Corp of America	91	Vital Industries	96
Data Communications	128-129	McCurdy Radio Industries	C-3	Ward Beck Systems	C-4
Datametrics	136	MCI/Quantel	109	Winsted	132
dbx	54	Merlin Engineering	82	Yamaha	61
Delta Electronics	20				
Digital Communications	59				
Dolby Laboratories	49				
Dubner	142				

**When accuracy Counts...Count on Belar
for AM/FM/TV MONITORS**



BELAR
AM MODULATION MONITOR

BELAR CALL ARNO MEYER (215) 687-5550
ELECTRONICS LABORATORY, INC.
LANCASTER AVENUE AT DORSET, DEVON, PA. 19333 • BOX 826 • (215) 687-5550

Circle 210 on Reader Service Card

No Needle-drop Fees!

A full contemporary American music library with unlimited use in any market.

Soper Sound charges no "needle drop" or "annual license" fees.

Soper Sound
MUSIC LIBRARY

It's simple.
it's direct.
it's a buy-out!

P.O. Box 498, Palo Alto, California 94301 (415) 321-4022 (800) 227-9980 (outside of California)

Circle 211 on Reader Service Card

SALES OFFICES

BM/E

Broadcast Management/Engineering

295 Madison Ave.
New York, New York 10017
Telex: 64-4001
National Sales Manager
James C. Maywalt

Eastern & Midwestern States

295 Madison Avenue
New York, New York 10017
212-685-5320
James C. Maywalt
Denis J. O'Malley

Western States

300 Broadway
Suite 20
San Francisco, CA 94133
415-421-7330
Sandy Fibish
18998 Skypark Circle, Suite 260
Irvine, CA 92714
714-556-6480

United Kingdom/Europe

Chiberton House
Doods Road
Reigate, Surrey, England
Telephone, Reigate 43521
Bronwyn Holmes
Derek Hopkins

Japan/Far East

Eiraku Building
1-13-9, Ginza,
Chuo-Ku, Tokyo 104 Japan
03 (562) 4781
S. Yasui
K. Yamamoto

For dependable, quality audio, make sure all the parts get along.

All metalwork is of welded, heavy-gauge steel construction with durable, textured epoxy paint. Dark blue finish.

Convenient housings in matching woodwork are available in a range of sizes for cart machines, auxiliary equipment and jackfields.

This modular stereo audio console (SS8670) is available in 16, 20 and 22 channel standard versions. Custom designs can be produced to meet specific requirements. The control panel is made of mar-resistant, heavy gauge, vinyl-coated steel strips, set into aluminum extrusions.

Sloping, front-hinged mounting panels are available for all popular reel tape machines.

High quality woodwork and trim is custom built to your specifications. Choose from solid oak or walnut.

McCurdy turntables are engineered for broadcast use, incorporating rugged construction, specialized features and weighted, isolating shock mounts.

Let McCurdy put it all together!

Technical harmony is essential to clear professional audio. All the components have to get along before the system can deliver its full potential.

At McCurdy, we strongly believe in technical harmony. It's the basis on which we've built all our dependable, quality audio systems for over 30 years. And because McCurdy can supply the complete system, we can guarantee that it will work together and work right.

Whatever the audio requirement, a McCurdy system can fill the need with quality components. Take our consoles for example . . . from standard versions to custom models, we cover the complete range of audio applications. Or our turntables . . . the only turntable systems designed specifically for broadcast. And all McCurdy audio systems are available with various tape configurations, turrets and/or jackfields.

Let McCurdy put together a complete audio system for your broadcast application. McCurdy components get along so well, you'll agree they were made for each other. And the result of that is technical harmony . . . the best audio possible!



MCCURDY RADIO INDUSTRIES
TORONTO (416) 751-6262
CHICAGO (312) 640-7077

In Our 4th Decade of Service
to the Broadcast Industry

Circle 212 on Reader Service Card

MicroCOM

This is Ward-Beck's superlative statement on the art of tomorrow's high technology digital communications systems.

The promise of microprocessor controlled "intelligent" circuitry has been fulfilled, and is already in operation. Its incredible flexibility allows unlimited access between all stations in the system and permits crosspoint assignments to be reprogrammed on a show-by-show basis.

ABC, Hollywood has it! CBC, Toronto has it! You'll find it at Molinare in England, and at WLS in Chicago.

WBS

First by Design

Ward-Beck Systems Ltd., 841 Progress Avenue, Scarborough, Ontario, Canada M1B 2X8.
Tel: (416) 438-8550.

Ward-Beck Systems Inc., 6900 East Camelback Road, Suite 1010, Scottsdale, Arizona 85251.